

December 2018

CAN Newsletter

Hardware + Software + Tools + Engineering

Reverse engineering of CAN communication

Implementing J1939 in vehicle design

Optimizing CAN bit configuration for robustness

CANopen and the Internet-of-Things

www.can-newsletter.org

Engineering

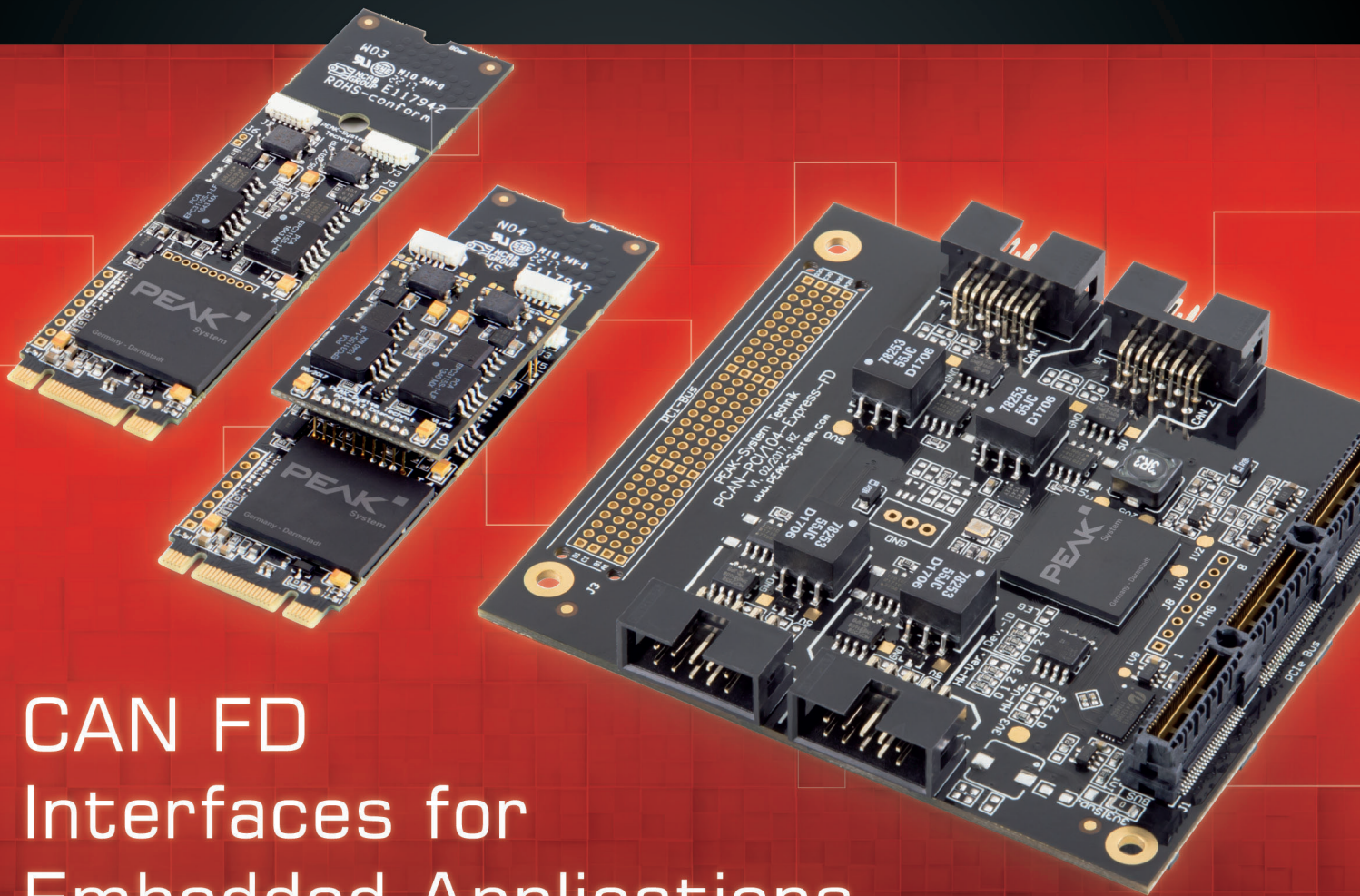

CAN FD Interfaces for Embedded Applications

■ PCAN-M.2

CAN FD Interface for M.2 (PCIe)

- CAN interface for the M.2 slot (uses PCIe lane)
- Form factor M.2 type: 2280/2260-B-M; Height: Single and Dual Channel 4.6 mm; Four Channel 10.2 mm
- 1, 2, or 4 High-speed CAN channels (ISO 11898-2)
- Complies with CAN specifications 2.0 A/B and FD
- CAN FD support for ISO and Non-ISO standards switchable
- CAN FD bit rates for the data field (64 bytes max.) from 20 kbit/s up to 12 Mbit/s
- CAN bit rates from 20 kbit/s up to 1 Mbit/s
- CAN bus connection via connection cable and D-Sub, 9-pin (in accordance with CiA® 303-1)
- Microchip CAN transceiver MCP2558FD
- Galvanic isolation on the CAN connection up to 300 V, separate for each CAN channel
- CAN termination can be activated through a solder jumper, separately for each CAN channel
- PCIe data transfer via bus master DMA
- DMA memory access operations with 32- and 64-bit addresses
- Measurement of bus load including error frames and overload frames on the physical bus
- Induced error generation for incoming and outgoing CAN messages
- Extended operating temperature range from -40 to 85 °C (-40 to 185 °F)

■ PCAN-PCI/104-Express FD

CAN FD Interface for PCI/104-Express

- PCI/104-Express card, 1 lane (x1)
- Form factor PC/104
- Up to four cards can be used in one system
- 1, 2, or 4 High-speed CAN channels (ISO 11898-2)
- Complies with CAN specifications 2.0 A/B and FD
- CAN FD support for ISO and Non-ISO standards switchable
- CAN FD bit rates for the data field (64 bytes max.) from 20 kbit/s up to 12 Mbit/s
- CAN bit rates from 20 kbit/s up to 1 Mbit/s
- Connection to CAN bus through D-Sub slot bracket, 9-pin (in accordance with CiA® 303-1)
- Microchip CAN transceiver MCP2558FD
- Galvanic isolation on the CAN connection up to 500 V, separate for each CAN channel
- CAN termination and 5-Volt supply can be activated through solder jumpers, separately for each CAN channel
- PCIe data transfer via bus master DMA
- DMA memory access operations with 32- and 64-bit addresses
- Measurement of bus load including error frames and overload frames on the physical bus
- Induced error generation for incoming and outgoing CAN messages
- Extended operating temperature range from -40 to 85 °C (-40 to 185 °F)

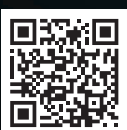

www.peak-system.com

Take a look at our website for the international sales partners. Scan the QR code on the left to open that page.

PEAK-System Technik GmbH

Otto-Roehm-Str. 69, 64293 Darmstadt, Germany
Phone: +49 6151 8173-20 - Fax: +49 6151 8173-29
E-mail: info@peak-system.com

PEAK
System



Engineering

Reverse engineering of CAN communication	4
Implementing J1939 in vehicle design	10
Optimizing CAN bit configuration for robustness	28
CANopen and the Internet-of-Things	40

Imprint

Publisher

CAN in Automation GmbH
Kontumazgarten 3
DE-90429 Nuremberg

publications@can-cia.org
www.can-cia.org

Tel.: +49-911-928819-0
Fax: +49-911-928819-79

CEO

Reiner Zitzmann

AG Nürnberg 24338

Downloads September issue:
(retrieved November 14, 2018)
2453 full magazine

Editors

pr@can-cia.org

Cindy Weissmueller (cw)
Holger Zeltwanger (hz)
(responsible according
to the press law)

Layout

Nickel Plankermann

Media consultants

Gisela Scheib
(responsible according
to the press law)
Gertraud Weber

Distribution manager

Holger Zeltwanger

© Copyright

CAN in Automation GmbH



Applications

CANopen used in medical systems	20
Digital maintenance concepts	36



Devices

Integrating absolute encoders simplifies machine design	22
Good to know: Better support for logical devices in CANopen FD	32
Connecting vehicles to the "clouds"	34
Wireless CAN without WLAN or Bluetooth	44

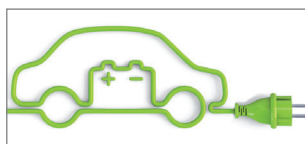

Semiconductors

CAN FD core as an open source project	18
Smart battery sensor with CAN interface	26

SPS IPC Drives and Bauma Shanghai

As usual, the SPS IPC Drives and Bauma Shanghai tradeshows take place at the very same week. CAN in Automation (CiA) serves both exhibitions and is present in Nuremberg as well as in Shanghai.

The SPS IPC Drives fair addresses the German and Middle European industrial automation market. CiA focuses on CANopen FD and will present first CANopen FD products on its stand 410 in hall 5. Additionally, the CiA staff will inform about all CAN-related topics ranging from physical layer to CANopen FD profiles. CiA will also inform its testing, publication, and training services. A couple of CiA member companies present their CANopen devices on a product panel.

The Bauma Shanghai is an exhibition on construction and mining machinery in Far East. CiA is again part of the German Pavilion in hall 2, stand 831. CANopen is one of the leading embedded network technologies on this market. Of course, there are also J1939-based networks and proprietary application layer protocols in use. There will also be a panel wall with CANopen products.

These both tradeshows are the last exhibition activities of CiA in 2018. Next year, CiA intends to participate at the Bauma, Embedded World, Interlift, and SPS IPC Drives fairs.

Reverse engineering of CAN communication

There are many applications, in which you may need to reverse engineer the CAN communication. Examples are automotive competitor analysis, telematics applications such as fleet management, and disabled driver applications.

The typical reverse engineering process is concerned with moving a sensor and watching the CAN network for message changes. For example, wind down a door window and see if this kicks-off changes in CAN frame data fields. Many CAN networks have many frames originating from many ECUs (electronic control units). This means it is difficult to watch all of them at the same time. It would be far easier if you could simply watch a smaller number of CAN data frames to observe changes by isolating the ECUs the frames originate from.

This article describes a process that allows the user to identify, which CAN data frames are transmitted by a particular ECU. This is achieved by getting the electrical signature of each CAN data frame and matching known frames with unknown ones. Therefore, the transmitting ECU of the unknown CAN data frame can be determined.

The method for determining, which identifiers come from a particular ECU, is to first get electrical signature plots of known diagnostic response frames and compare with electrical signature plots of the real-time control frames. We show how to achieve this using Warwick Control's tool X-Analyser coupled with a Picoscope PC oscilloscope and a Kvaser CAN USB interface.

What is a CAN message electrical signature?

A CAN interface electrical signature is something that is largely unique about any CAN data frame sent by an ECU. Therefore, you would expect all bits transmitted by an ECU to have the same electrical characteristics. For example, a CAN bit comprising of the voltages of CAN High and CAN Low (CAN_H and CAN_L) should show something unique for each ECU due to the physical makeup of the CAN interface (e.g. node position and distance on the bus).

Figure 1 shows different fields that make-up a CAN data frame. Due to the nature of the contention-based access method of CAN, the arbitration field (containing the CAN ID) should not be considered for the electrical signature, as there may be several ECUs communicating within this field and therefore influencing the electrical signal.

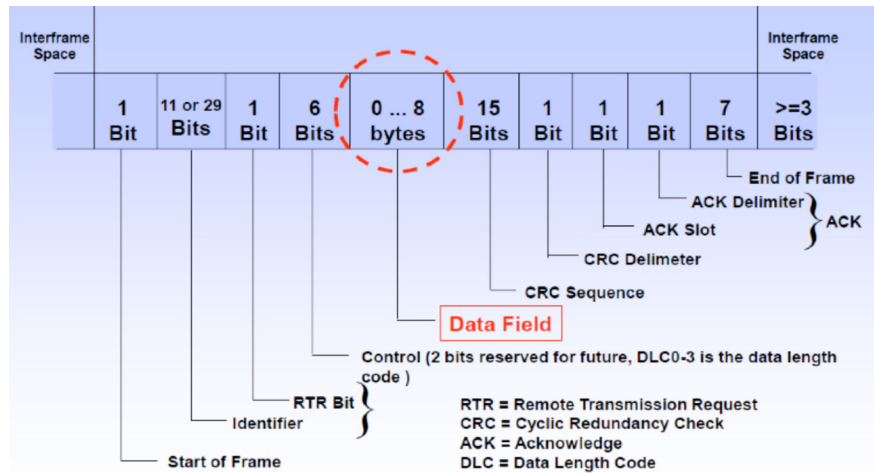

Figure 1: Construction of CAN frame (Source: Warwick Control)

Once the arbitration process is completed, there is just one ECU sending bits to the network. This is where you see a unique electrical signature for this ECU. To obtain a unique signature that represents its transmitting ECU, the measurements should be taken from this part of the CAN frame, which is when only one ECU is transmitting.

To illustrate the unique electrical characteristics of each ECU in a vehicle, Figure 2 and Figure 3 show the slight differences in the CAN_H and CAN_L voltages for two different ECUs from a modern passenger car. These are referred to as ECU A and ECU B. It can be seen that the CAN_H and CAN_L voltage levels are different for these two ECUs.

Generating electrical signatures

The methodology considered in gathering an electrical signature for each CAN bit, allowing us to ascertain the ECU it comes from, is to consider the CAN_H and CAN_L voltage values to associate CAN data frames to ECUs.

Method– Analysing the voltages of CAN_H versus CAN_L Process:

- ◆ Log one example of each CAN message oscilloscope trace
- ◆ Isolate the CAN data field only
- ◆ Split CAN data field bits into dominant (logic 0) and recessive (logic 1)
- ◆ Calculate modal average value of CAN_H and CAN_L voltage levels for dominant bits only

Data is now ready for cluster plots. ▶

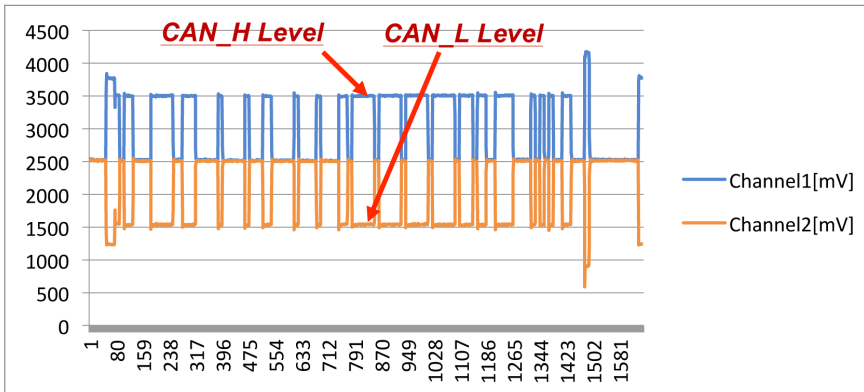

Figure 2: ECU A – electrical characteristics (Source: Warwick Control)

Example in X-Analyser: Figure 4 shows the display in X-Analyser utilizing the Picoscope interface. Here you can see CAN data frames are logged on the top half of the display. One of the CAN data frames is selected (highlighted), and the physical signaling of that frame is shown on the lower half of the display. Note that from this, we can gather the voltage levels of the dominant bits in the data field (CAN_H, CAN_L).

These waveforms can be exported as an Excel file to show readings of the CAN data frame at a sample point. This is done within X-Analyser by the “export frame” button to export the selected frame and using the “export all” button to export all the frames on that collection. An example of the data that is exported is shown in Figure 5.

The information given in the Excel file is:

- ◆ Frame ID (hexadecimal)
- ◆ DLC
- ◆ Data (bytes in hexadecimal)
- ◆ Error frame (true or false) (false if a good CAN frame)
- ◆ Samples per second
- ◆ Exported on (date)
- ◆ Time (of sample for that frame, starts at zero)
- ◆ CAN-H and CAN-L voltages
- ◆ Region name (region of the frame the data showing, is in)
- ◆ Additional region (shows where bit stuffing occurs)

Once this information is exported to Excel, we can calculate cluster points using the method taking the modal average of CAN_H and CAN_L voltages from CAN data field (dominant bits only).

The data is analyzed by recording the level of CAN_H and CAN_L dominant bit voltage levels within the data field and coming up with a single modal average measure for both CAN_H and CAN_L. These can then be put onto a cluster plot so that the clustering of CAN messages from a particular ECU can be observed. The following case study illustrates the data collection methods, and process utilized in plotting the CAN ID clusters from the Excel modal average values. This allows a researcher/ ▶



Sontheim 

Your reliable partner for innovative CAN systems

From design over implementation to testing

- ▶ Mobile or stationary CAN Interfaces in various form factors with WLAN, Bluetooth, Ethernet, USB and more
- ▶ Robust CAN Gateways and Data Logger with up to 256GB of built-in NAND-Flash-Memory
- ▶ Rugged ECUs for controlling, telematic services and diagnostic application
- ▶ Monitoring and analyzing - our modular software tools for efficient fieldbus diagnostics
- ▶ Searching for a modular diagnostic tool based on standards? Have a look on our MDT! <http://www.sontheim-industrie-elektronik.de/en/products/automotive/diagnostics-tools/>



Modular Diagnostic Tool 2.0
ODX 2.2 and OTX Standard
MCD-3D Server



Automotive



Automation



Diagnostics



HW & SW-
Development

We live electronics!
www.sontheim-industrie-elektronik.de

DE Sontheim Industrie Elektronik GmbH
Georg-Krug-Str. 2, 87437 Kempten
Tel: +49 831 57 59 00 -0 - Fax: -73
info@s-i-e.de

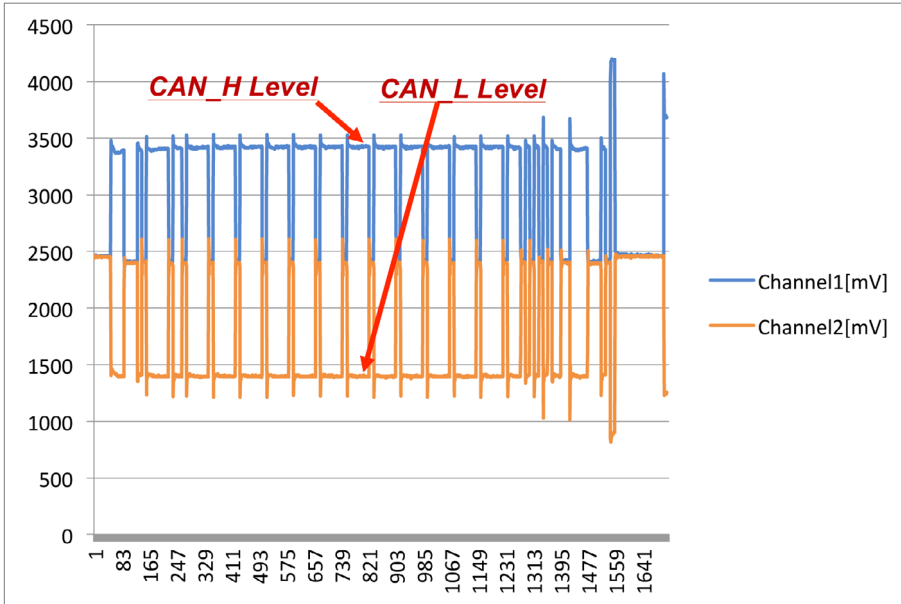

Figure 3: ECU B – electrical characteristics (Source: Warwick Control)

engineer to ascertain, which ECU has originated the real-time CAN data frame.

Methodology for identifying transmitting ECU

The basis for this methodology is that each ECU on the CAN network will exhibit its own unique electronic characteristics which are influenced by aspects such as its electrical components and tolerances, CAN transceiver, connector characteristics, and location in the CAN network. This can therefore be used to match unknown CAN data frames with known CAN data frames. In the automotive industry, the real-time control CAN data frames are proprietary. However, the identifiers diagnostic messages used for manufacturing and service garages are standardized in the ISO 15765 series and/or across an automotive manufacturer.

It is well known that many vehicles using standardized CAN identifiers to make a diagnostic request to the engine controller: For example, CAN-ID 7E0h and that the engine controller responds on CAN identifier 7E8h. Therefore, the summary of the methodology is described by the following steps:

- ◆ Send diagnostic requests
- ◆ Get signatures of all responses and real-time CAN data frames
- ◆ Analyze and plot the data on a cluster diagram

Figure 6 shows an example of the equipment setup utilizing X-Analyser connected to the CAN network via the Kvaser CAN/USB interface and the Picoscope interface. Referring to Figure 6, the Kvaser interface is used to generate diagnostic request messages, and the Picoscope is used to receive the diagnostic response message for analysis of the physical signature.

X-Analyser software is used to create the transmitters of CAN-ID 7E0_h (or 700_h to 7FF_h for other ECUs) through the object transmitter and uses the Kvaser interface to send these messages onto the bus. The Picoscope will see the sent transmitter (CAN-ID 7E0_h) and read the response to this message of CAN-ID 7E8_h. The frame bits of the data frame with the CAN-ID 7E8_h can then be analyzed through the analog network analyzer in X-Analyser.

More information about the diagnostic request can be found in ISO 15765-4:2016 [1]. The basic information needed is diagnostic request have the hexadecimal CAN-IDs ranging from 700_h to 7FF_h.

The standard emission diagnostic request message is known to be ID 7E0_h and the expected response from the ECM (Engine Control Module) is ID 7E8_h. Referring to ISO 15765-4:2016, page 29, it also known that the TCM (Transmission Control Module) diagnostic request CAN-ID is 7E1_h, and the response frame uses the CAN-ID 7E9_h. Many of the other ECUs are manufacturer-specific, but most can be ascertained utilizing an OBD tool for a particular car model. For example, in many models, the ABS ECU is known to have a request of using the CAN-ID 7E2_h and a response using the CAN-ID 7EA_h.

A diagnostic response's ID will increase in value by 8 and give the response i.e.;

$$\text{Request ID} = 7E0_h \quad \text{Response ID} = 7E8_h \quad 8 = 7E8_h \text{ to } 7E0_h$$

An example of diagnostic request CAN data frame is;

$$\text{CAN-ID} = 7E0_h \quad \text{DLC} = 8 \quad \text{Data} = 02 \ 10 \ 01 \ 00 \ 00 \ 00 \ 00 \ 00$$

Therefore, we expect a response from the Emissions (Engine) ECU using the CAN-ID 7E8_h.

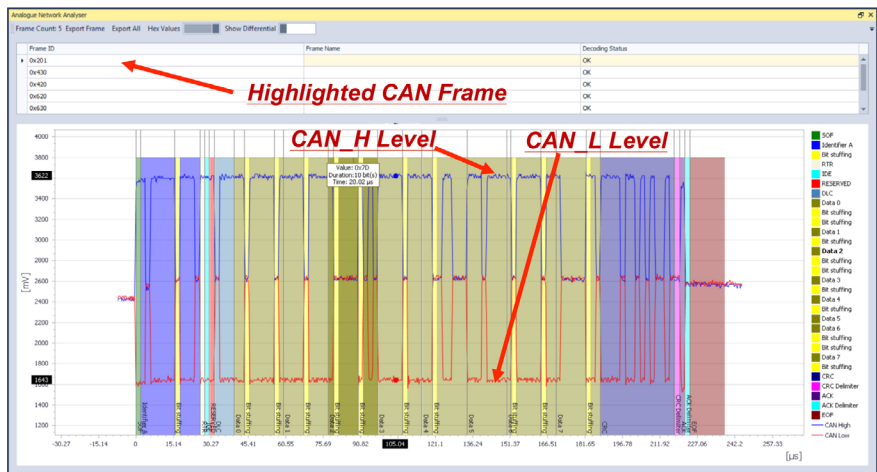

Figure 4: Highlighting a CAN frame within a Picoscope display (Source: Warwick Control)

	A	B	C	D	E	F	G	H
1	Export of Decoded CAN Frame			Time (us)	CAN High (V)	CAN Low (V)	Region Name	Additional Region
2	Frame ID	1CFFBC00		0	2.264	2.217	SOF	
3	DLC	8		0.144000009	2.303	2.257	SOF	
4	Data	C4 F8 FF FF 0B 27 C8 07		0.288000018	2.264	2.257	SOF	
5	Error Frame	FALSE		0.432000028	2.303	2.257	SOF	
6	Samples per Second	6944444		0.576000037	2.303	2.257	SOF	
7	Exported On	01/02/2018 10:43		0.720000046	2.303	2.257	SOF	
8				0.864000055	2.303	2.257	SOF	
9				1.008000065	2.303	2.217	SOF	
10				1.152000074	2.303	2.257	SOF	
11				1.296000083	2.264	2.257	SOF	
12				1.440000092	2.264	2.257	SOF	
13				1.584000101	2.303	2.257	SOF	
14				1.728000111	2.303	2.257	SOF	

Figure 5: Example Excel data exported for an extended CAN frame (Source: Warwick Control)

If there is no response to other requests, it means that this diagnostic function is not supported in this vehicle. The plotted chart in Figure 7 shows the diagnostic response messages in the 1st candidate car. From this, we ascertained the Electrical Signatures of CAN-IDs 728_h, 7E8_h, 738_h, and 768_h. From the manufacturer's specification, it is possible to establish the functions of these ECUs.

Data capture on X-Analyser and Picoscope

The clusters show, which messages are associated with the same ECU. The results from two candidate vehicles are shown on the next page. Candidates 1 and 2 were electrically good CAN networks i.e. good grounds and low noise. The methodology used here was to plot the modal CAN-H and CAN-L values from the data segment of the CAN data frame to produce the clusters shown. This modal value

would be taken from the region of the CAN data field bits for dominant ones only.

Candidate 1: In the 1st Candidate vehicle, the diagnostic request messages were sent with the response results that plots the electrical signature shown in Figure 7.

Here we are plotting the cluster points using CAN_H versus CAN_L. From the specification of this

vehicle, the resulting diagnostic response frames are interpreted as follows:

- ◆ CAN-ID 728_h – Instrument cluster
- ◆ CAN-ID 7E8_h – Engine ECU
- ◆ CAN-ID 738_h – Steering ECU
- ◆ CAN-ID 768_h – Brake control module ECU

After the diagnostic response signature is established, we then collected the real-time CAN control frames and plot the electrical signature shown in Figure 8.

Here we have established that the general electrical signatures of the real-time CAN data frames closely match up with the diagnostic response messages. Therefore, we can ascertain that they come from the following ECUs:

- ◆ CAN-IDs 190_h, 275_h, 430_h, 433_h, 460_h from Instrument ECU

CAN Products for your requirements



CAN-Repeater
CRep DS 102



CAN-LWL-Router
CG FL



CAN-Repeater
CRep S4

- Repeaters for different network topologies
- Stub line connection of networks segments
- Optical fibre connection of copper networks
- Cost effective star repeater with 4 channels



Sonnenhang 3
D-85304 Ilmmünster
Tel.: +49-8441-49 02 60
Fax: +49-8441-8 18 60
www.ems-wuensche.com

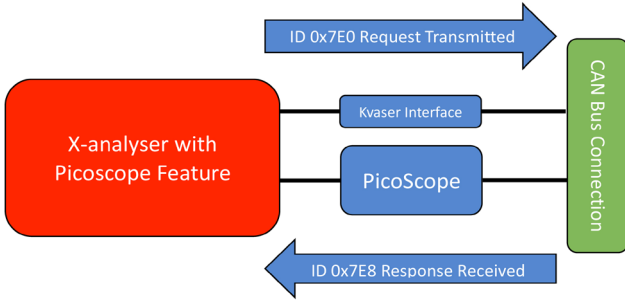

Figure 6: X-Analyser connection to a car via Kvaser interface and PicoScope PC oscilloscope (Source: Warwick Control)

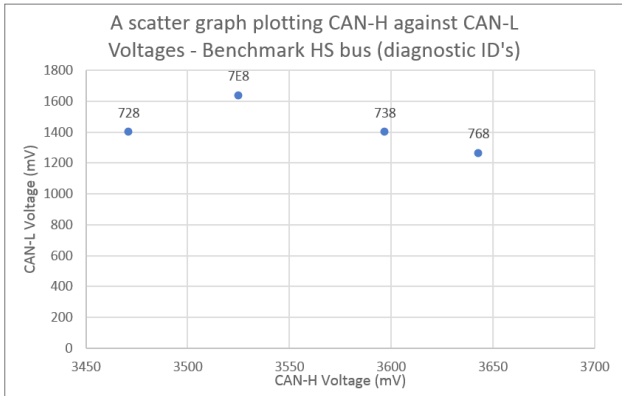

Figure 7: Cluster plot of the diagnostic response CAN messages for vehicle candidate 1 – CAN_H modal voltage versus CAN_L modal voltage (Source: Warwick Control)

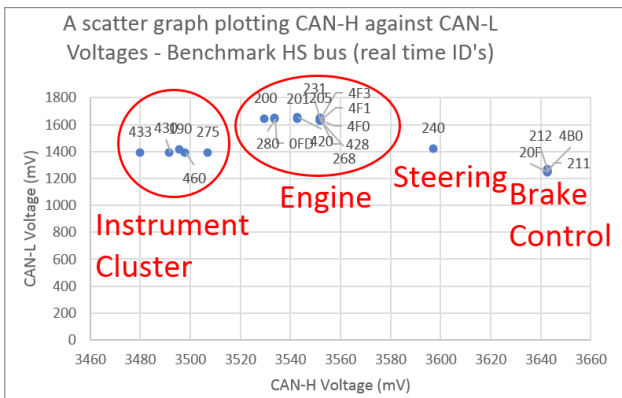

Figure 8: Cluster plot of the real-time CAN messages for vehicle candidate 1 – CAN_H modal voltage versus CAN_L modal voltage (Source: Warwick Control)

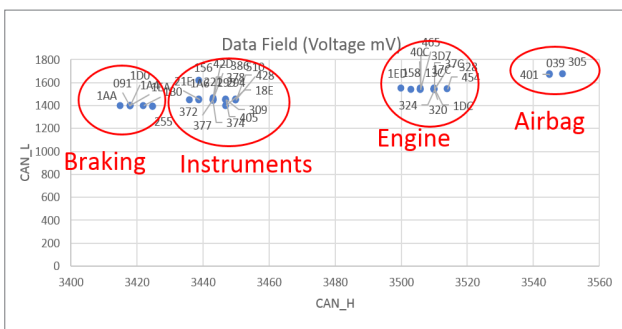

Figure 9: Cluster plot of the real-time CAN messages for vehicle candidate 2 – CAN_H modal voltage versus CAN_L modal voltage (Source: Warwick Control)

- ◆ CAN-IDs 200_h, 201_h, 205_h, 231_h, 268_h, 280_h, 420_h, 428_h, 4F0_h, 4F1_h, 4F3_h from Engine ECU
- ◆ CAN-ID 240_h from EHPAS ECU
- ◆ CAN-IDs 20F_h, 211_h, 212_h, 4B0_h from Brake control ECU

This information will allow reverse engineering methods to help ascertain the functions of these CAN messages. In X-Analyser, it is possible to isolate these messages and perform various investigation methods to determine the functions of the individual signals within these messages.

Candidate 2: To further verify the validity of this method, a similar method was performed on a 2nd candidate vehicle for which the CAN specification was available. The result is illustrated in Figure 9 showing the electrical signatures of the captured real-time data of this vehicle.

Here we can observe that the messages come from the following ECUs:

- ◆ CAN IDs 091_h, 1AA_h, 1A4_h, 1B0_h, 1D0_h, 1EA_h, 255_h from Brake control ECU
- ◆ CAN IDs 156_h, 18E_h, 1A6_h, 21E_h, 221_h, 294_h, 295_h, 309_h, 372_h, 374_h, 377_h, 378_h, 386_h, 405_h, 428_h, 42D_h, 510_h from Instrument ECU
- ◆ CAN IDs 13C_h, 158_h, 17C_h, 1DC_h, 1ED_h, 320_h, 324_h, 328_h, 376_h, 3D7_h, 40C_h, 454_h, 465_h from Engine ECU
- ◆ CAN IDs 039_h, 305_h, 401_h from Airbag ECU

Summary and Conclusion

The method shown in this article can be used as evidence to support hypotheses when reverse engineering. Many times, during reverse engineering exercises, we want to isolate CAN data frames from a particular ECU. This method of plotting electrical signatures by noting the modal average of CAN_H versus CAN_L levels for each CAN data field bits has shown that it is a very good assistance in accomplishing this.

The approach shown in this article is not limited to Classical CAN networks. CAN FD is the obvious next network to look at. However, electrical signatures could be obtained for many other network technologies e.g. Flexray, which uses also a differential signaling approach. It may be possible to characterize the signals on a LIN network. However, a slightly revised approach would need to be adopted for deriving an electrical signature since it does not use differential signaling.

References

- [1] ISO 15765-4 (2016) - Road vehicles — Diagnostic communication over Controller Area Network (DoCAN) Part 4: Requirements for emissions-related systems

Authors

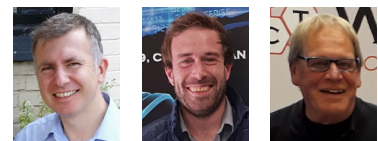

Dr. Chris Quigley, David Charles, Richard McLaughlin
 Warwick Control Technologies
enquiries@warwickcontrol.com
www.warwickcontrol.com

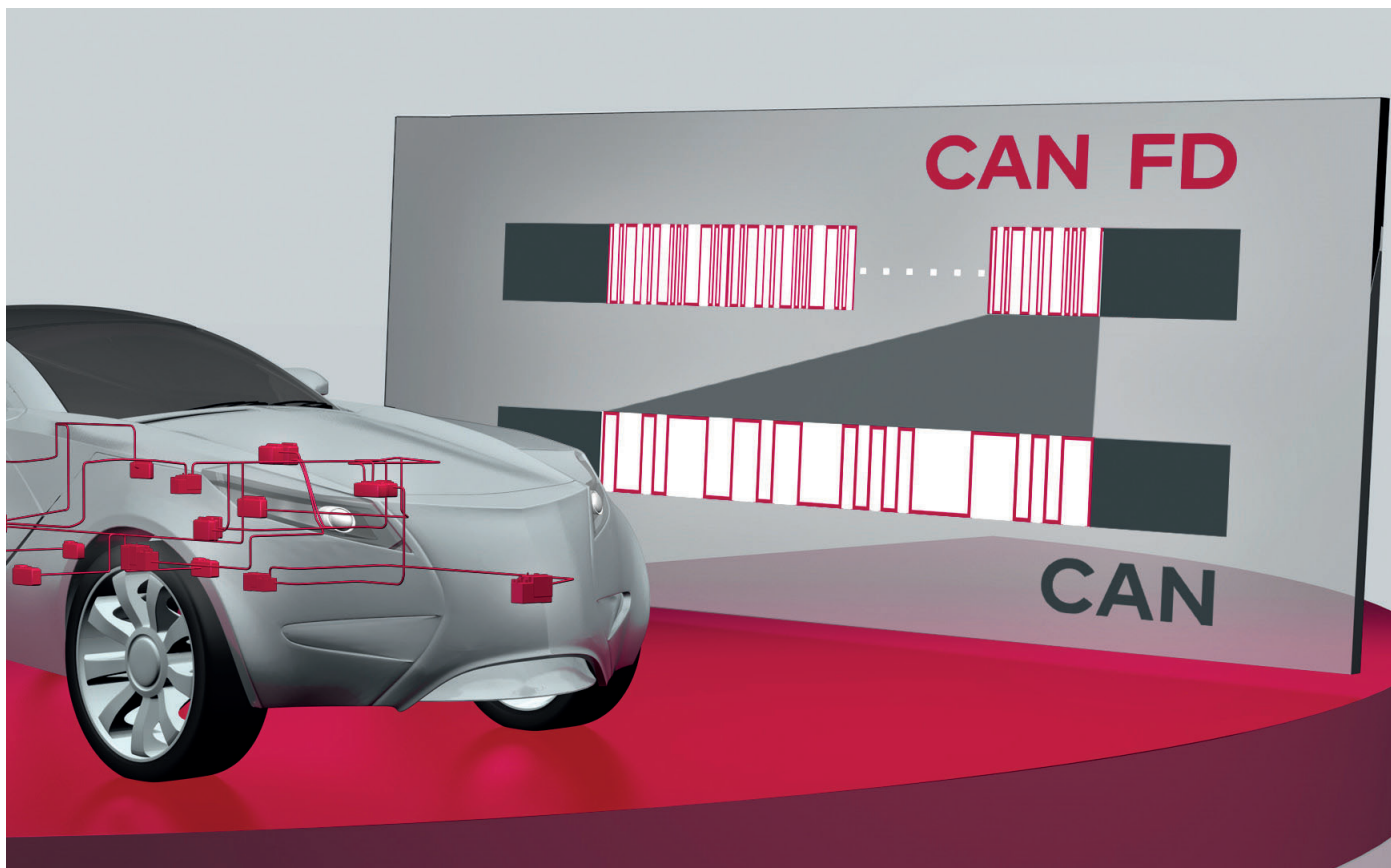

First Class Solutions for Your CAN (FD) Projects

Your Universal Tool Chain

Increase efficiency of your projects with the universal tool chain from Vector:

- > High-professional tools for testing, flashing and calibrating ECUs
 - > Flexible network interfaces
 - > New all-in-one network disturbance interface
 - > Powerful logging solutions for test fleet operators
 - > High performance oscilloscope
 - > Proven design tools for network architectures
 - > Easy to configure AUTOSAR basic software
 - > Worldwide engineering services and trainings
- More information: www.can-solutions.com

More CAN power by Vector: benefit from 30 years of networking experience.

Implementing J1939 in vehicle design

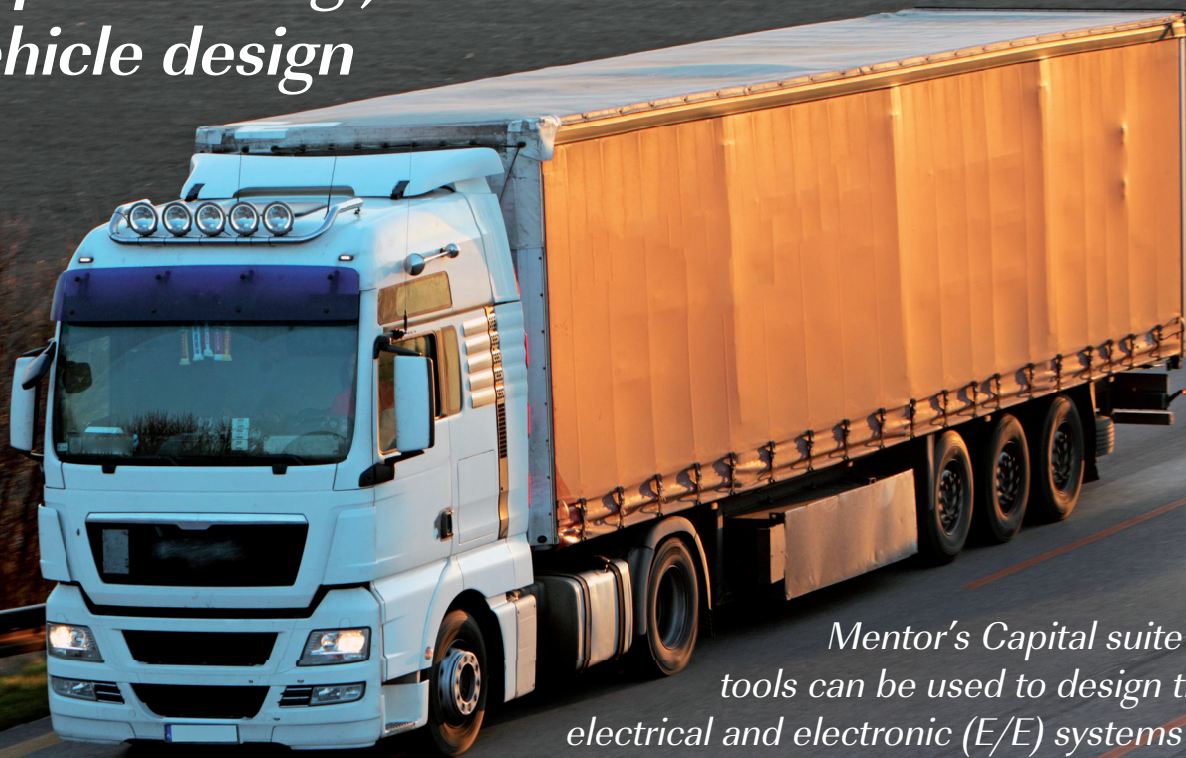

Mentor's Capital suite of tools can be used to design the electrical and electronic (E/E) systems of the vehicle from the E/E architecture definition.

(Source: Mentor)

Heavy-duty commercial and off-highway vehicles, such as agricultural and construction equipment, pose multiple electrical and mechanical engineering challenges. These vehicles must be efficient, durable, and reliable as they have long service lives in strenuous environmental conditions that can include extreme temperature, dirt, dust, and altitude.

The challenge of designing commercial and off-highway vehicles is mounting as the electrical systems grow in size and sophistication. Several interconnected networks of electronic control units (ECUs), sensors, and actuators monitor and control the critical systems in modern vehicles. This system of ECUs is constantly measuring suspect parameters (sometimes also referred as signals) such as temperature, pressure, and position of various components. This system also controls the activation of electrical and hydraulic actuators, engine, and driveline ancillaries, and much more. The increasing systems complexity of commercial and off-highway vehicles is similarly evident in the cabin. Agricultural tractors, for example, now feature electronic and digital controls as well as cabin amenities like heated seats and climate control systems (Figure 1).

Engineers must determine how to manage the communications and connectivity between the various electrical and electronic components. Therefore, one of the first steps for new vehicle design is defining the electrical and electronic (E/E) architecture. In the definition stage, engineers evaluate various proposals for the layout of the new vehicle and conduct trade studies to determine the quantity, type, and location of the necessary ECUs to enable the functionality required for the desired vehicle features. The architectural design data can then feed the downstream electrical, network, software, and hardware implementation.

A key consideration during commercial and off-highway E/E architectural definition is the SAE J1939 specification series for communications between ECUs in the vehicle. J1939 is a higher-layer protocol (HLP) for communications across the CAN network that provides standardized application layer messages and conversion rules across commercial, off-highway, and heavy-duty manufacturers. These rules support interoperability between manufacturers and implementations, such as between tractor unit and trailer.

SAE J1939DA is comprised of a set of parameter group (PGs) and suspect parameter (SPs). The PG identifies the set of related parameters the communication is addressing, and the SP identifies a specific parameter within the group. For example, there is a PG identifying data related to engine temperature. Within that PG, there are SPs to identify specific temperature data for the engine coolant, fuel, oil, turbo-charger oil, and intercooler.

Since its creation, J1939 has become widely adopted in heavy-duty road vehicles and off-highway applications such as commercial semi-trucks and construction equipment. A number of derivatives of the standard have also been developed for agricultural, forestry, and marine applications, as well as for interfacing with fleet management systems. With the growth of the IoT and connected vehicles, J1939 networks becomes more important as trucks, busses, and other large vehicles began to communicate with each other and into the cloud.

Traditionally, heavy duty commercial and off-highway vehicle manufacturers have taken a separated approach to electrical design that creates silos for hardware, software, networks, and electrical distribution system (EDS) design (Figure 2). Teams work separately and exchange data manually using email, marked-up PDF files, or Microsoft Office ▶



Figure 1: New agricultural tractor cabins are equipped with electronic controls and displays (Source: Mentor)

tools. These manual data exchanges prevent effective collaboration between teams and present a number of challenges to the design cycle. For one, when integrating between domains, it is important that teams are able to obtain the most up-to-date data from the other design domains. With manual data exchange, engineers must sort through massive file systems to locate the correct data. This increases the likelihood that one of the design teams proceeds with out-of-date data, introducing errors into the design.

Furthermore, as commercial and off-highway vehicles grow in complication, current design methods are approaching the limits of their capabilities. When conducting trade studies, teams discover optimizations for the types and locations of ECUs, parameter and message mapping, and the architectural layout. For example, switching to a new supplier of an existing ECU may drive a change in functional partitioning, enabling the combination of functions into fewer ECU's, reducing cost. With existing methods, implementing these changes into a design requires the manual exchange of dozens of files, increasing downtime, and the potential for the introduction of errors.

Traditional design methodologies also struggle to quantify the knock-on effects of these design changes. Each change affects the rest of the system, and the unforeseen effects can be very difficult to predict. Migrating an ECU to a new location or network in the architecture may affect performance elsewhere in the system. This change in behavior may cascade, causing any number of sub-systems or functions to fail. Such a change can even completely invalidate the technical implementation of the architecture, driving the re-design of multiple systems. The effects can also

All you CAN plug

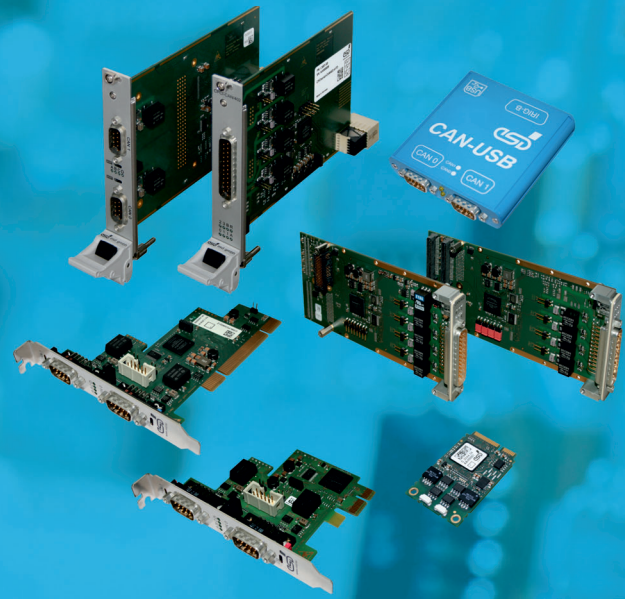

CANopen^{FD}

CAN^{FD}

CAN FD and CAN classic product line 402
Interfaces with various form factors:

- CAN PCI Express[®] Mini
- CAN PCI and PCI Express[®]
- CAN USB
- CompactPCI[®] and CompactPCI[®] Serial CAN
- XMC and PMC CAN (optional IRIG-B)

The boards are available in **different versions** from 1 to 4 channels as CAN FD or CAN classic models.

The entire series of CAN FD interfaces is controlled by the **high performance esdACC** implemented in an Altera-FPGA.

esd electronics supports the **realtime operating systems** VxWorks[®], QNX[®], RTX, RTOS-32 and others as well as Linux[®] and Windows[®] 32/64 Bit systems.

Efficient **CAN monitoring and diagnostic tools** for Windows (CANreal, COBview, CANplot, CANscript and CANrepro) are **included**.

Besuchen Sie uns auf der
sps ipc drives



Nürnberg 27.-29.11.2018
Halle 5, Stand 131



esd electronics gmbh
Vahrenwalder Str. 207
30165 Hannover
Germany
Tel.: +49-511-3 72 98-0
info@esd.eu
www.esd.eu

US office:
esd electronics, Inc.
70 Federal Street - Suite #2
Greenfield, MA 01301
Phone: 413-772-3170
us-sales@esd-electronics.com
www.esd-electronics.us

www.esd.eu

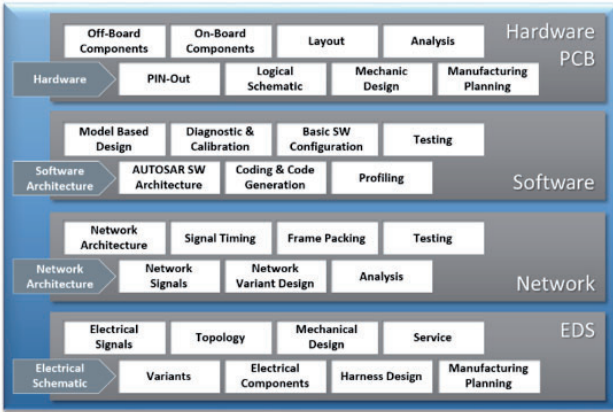

Figure 2: Manufacturers traditionally accomplish hardware, software, network, and EDS design separately (Source: Mentor)

be smaller and more subtle, making it difficult to predict and assess the net outcome of a change.

Without a robust, comprehensive design tool, engineering teams run the risk of sinking excessive time, cost, and effort into resolving these issues. Understanding and validating the impact of the required changes is crucial to accurately implementing the design intent. Tight integration between the electrical design domains enables teams to explore multiple potential implementations and consider the best iteration with which to update the E/E architecture, including where to host functions, which networks to connect ECUs to and so forth.

The Capital electrical system design and integration software suite is a data-driven solution that brings all of the electrical design aspects together into an integrated functional E/E architectural design (Figure 3). The same data is shared across electrical domains: Capital Systems Capture imports and creates functional designs, and Capital Systems Architect places the functions on to the vehicle E/E architecture. This allows the functional design to feed requirements to downstream flows within Capital and the other E/E domain tools. With Capital, one tool chain and one data flow unifies the entire electrical design from architectural definitions through to the physical implementations.

Integrating the domains of electrical design helps ensure accurate and optimized designs despite the immense complexity of modern commercial and off-highway vehicle systems. For example, commercial and off-highway OEMs frequently use a mixture of in-house, Tier-1 supplier, and hybrid designs for the electronic control units (ECU) inside their vehicles. This results in an electrical system with an array of hardware and software interfaces that must communicate. Then, feature requirements can change when transitioning between model years or designing new derivatives of the vehicle architecture. Consequently, ECUs may need to be relocated, replaced, or merged to support new features or to adapt to new implementations of existing features within the architecture.

J1939 design flow

Modern commercial and off-highway vehicles contain up to six CAN networks to transmit data around the vehicle architecture. The CAN networks connect the dozens of ECUs in the vehicle architecture and carry critical information that ensures the vehicle operates smoothly and safely. Commercial and off-highway OEMs must re-design or update these complex network designs for each new vehicle or derivative they produce. Therefore, an accurate and efficient design flow for J1939 networks is a critical piece of commercial and off-highway vehicle development.

Capital provides a streamlined design flow for J1939 networks, beginning with the creation of a dictionary of the parameters and messages that make-up the communications on the CAN-based J1939 network. Capital can receive Excel, XML, or DBC files containing the standardized set of SP (suspect parameter) parameters and the PG (parameter group) messages as defined in SAE J1939-21, J1939-71, and SAE J1939DA. From this input, Capital forms a dictionary of the J1939 SPs, PGs, the association of SPs to PGs, and any other parameters and messages in the corporate dictionary (Figure 4).

From the initial import, the parameters dictionary includes the SPs specified in J1939 documents. J1939 specifications provide an extensive set of parameters and messages, but this may still need to be embellished with specific parameters and messages that the OEM or project demands. With Capital, engineers can enrich the J1939 dictionary with additional parameters and messages bespoke to the project or manufacturer. For example, many commercial trucks are equipped with turbocharged engines. For a semi-truck design, the parameters and messages dictionary would need to include SPNs related to the turbocharger like boost pressure, mass airflow, intake air temperature and so forth, which may need custom scaling due to implementation requirements.

After importing a design, engineers can view the included PGs and the SPs within Capital Systems architect as networks and communications reports. In this view, the engineers can analyze the parameters and message mapping in terms of its functional and connectivity properties. This enables further assignments or overrides to modify the content of the standard designs to fit the needs of the project at hand. For instance, engineers can modify specific property

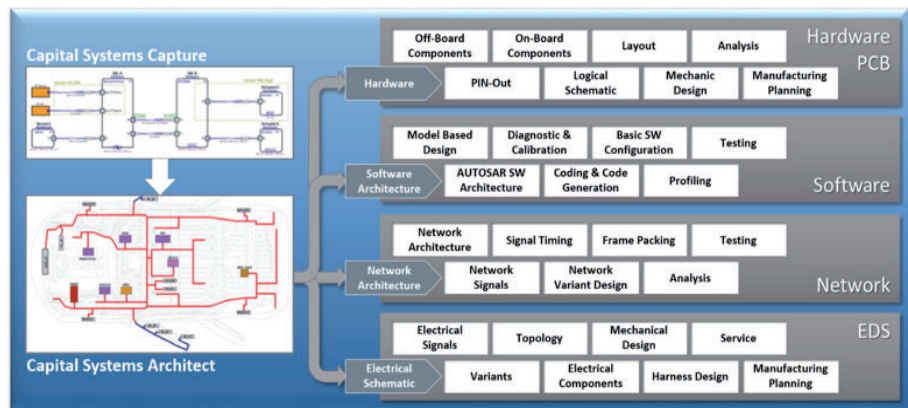

Figure 3: Capital provides an integrated design flow for all aspects of electrical systems design (Source: Mentor)

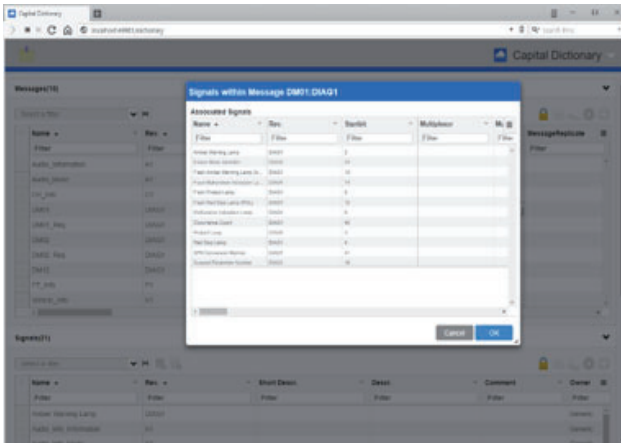
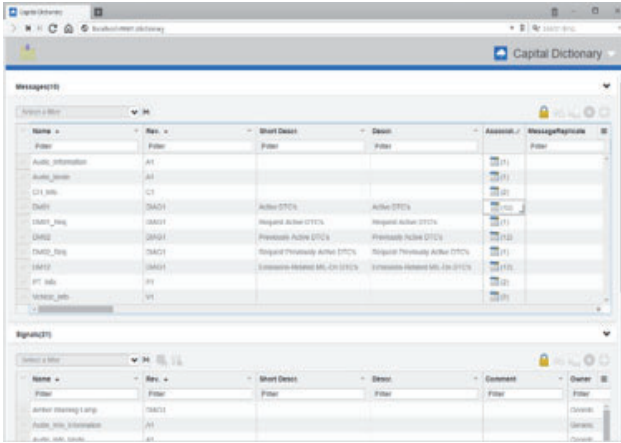

Figure 4: Capital can create a dictionary (top) of SAE J1939 SPs, PGs, the mappings between them (bottom), and other corporate parameters and messages (Source: Mentor)

values depending on the implementation, avoiding the need to create unique parameters and messages to account for small differences. This capability facilitates the reuse of existing design data by allowing engineers to adapt existing designs to the specific needs of the target implementation.

Engineering teams can then use this dictionary to streamline future implementations. With a library of reusable design artifacts, engineers are quickly and accurately able to integrate proven architectures, SP and PG mappings, and functional designs into a new vehicle's electrical and electronic systems (Figure 5). In the above example, any future turbocharged vehicle designs would already have a robust dictionary of parameters and messages to implement in the vehicle network. The reuse of these assets significantly improves design efficiency while simultaneously handling the thousands of parameters required for modern vehicle networks.

The ability to reuse existing design data is a key advantage of an integrated electrical design flow. By reusing existing design data, engineers can reduce design errors and minimize or eliminate the need for lengthy redesign processes. Capital enables engineers to import black box functional designs and logic models, further leveraging the advantages of design data reuse (Figure 6). It is also possible to import an existing platform plane, complete with properties defined in the 3D CAD environment, or an abstracted networks logical architecture to use in the architectural platform design view, depending on user preference. ▶

A Single, Flexible Tool For Accessing CAN & LIN

Introducing the Kvaser Hybrid 2xCAN/LIN, a dual-channel interface that allows each channel to be assigned independently as CAN or LIN.



Features Include:

- ▶ Supports High Speed CAN and LIN 2.2A up to 20 kbit/s.
- ▶ Capable of sending up to 20,000 messages per second, per CAN channel.
- ▶ Supports CAN FD up to 5 Mbit/s.
- ▶ Supplied with Kvaser CANlib and Kvaser LINlib, free software APIs.
- ▶ Extended operating temperature range from -40 to 85 °C.

Download our Hybrid Guide at www.kvaser.com/hybrid or contact us at +46 31 886344 or sales@kvaser.com to find out more.

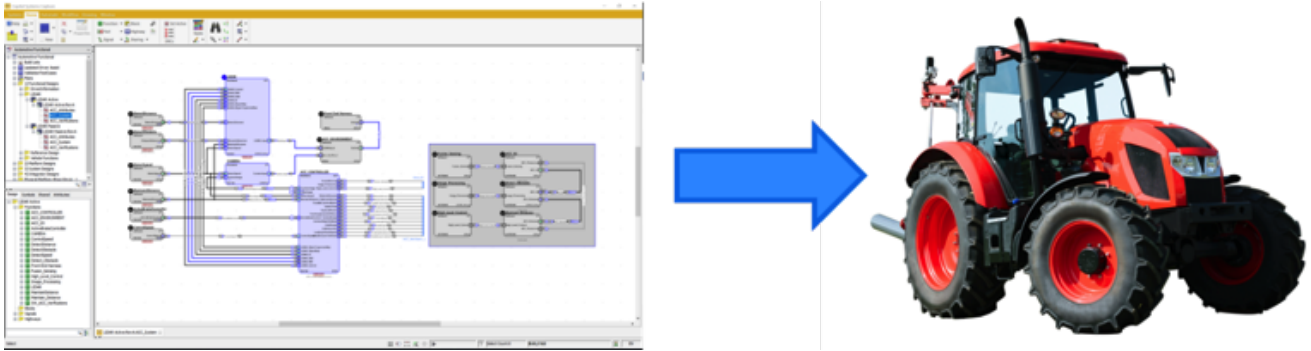

Figure 5: Engineering teams can streamline the design cycle by integrating pre-existing design artifacts (Source: Mentor)

Design data reuse

Existing design data provides engineers with a wealth of proven and verified assets to employ in new vehicle designs. By reverse engineering existing logic models, engineering teams can generate robust logic designs and component libraries (Figure 7). Functional designs can be imported to create the software, hardware, network and electrical functions for the vehicle. Pre-existing vehicle architectures can also be imported to jumpstart device placement, harness routing channel design, connector locations and more. Finally, engineers can incorporate model-based systems engineering data stored in XML to further inform and refine the design.

As with the J1939 dictionary of parameters and messages, engineering teams sometimes need to adapt imported functional designs for the new vehicle architecture. These changes can compromise the efficiency of the default parameters to message mapping, resulting in a design in which many messages exist, with only a few SPs mapped to each. A common solution is to redesign the allocation of functions

to ECUs in the architecture, co-hosting some functions on the same ECU. This increases the number of SPs mapped to each message, making the design more efficient. With Capital, engineers can quickly reallocate functions around the vehicle architecture streamlining the evaluation of design permutations and the implementation of an optimal solution (Figure 8). Alternatively, the imported functional design may already describes what is on the CAN. In this case, the engineers may wish to add further design details, such as power and ground, or map out the sensor and actuator placement and the resultant flow of data. This provides the opportunity to re-optimize the location of functions for better network bandwidth, shorter power runs, or to reduce the EDS mass. When allocating functions to ECUs in the architecture, the engineer can choose to do so manually or through rules-based automation. Once the functions are allocated to architectural components, Capital can analyze system features such as process loading and network bandwidth utilization to determine if they fall within acceptable ranges (Figure 9).

Model-based analytic capabilities enable further optimization to the architectural and network design. Capital can >

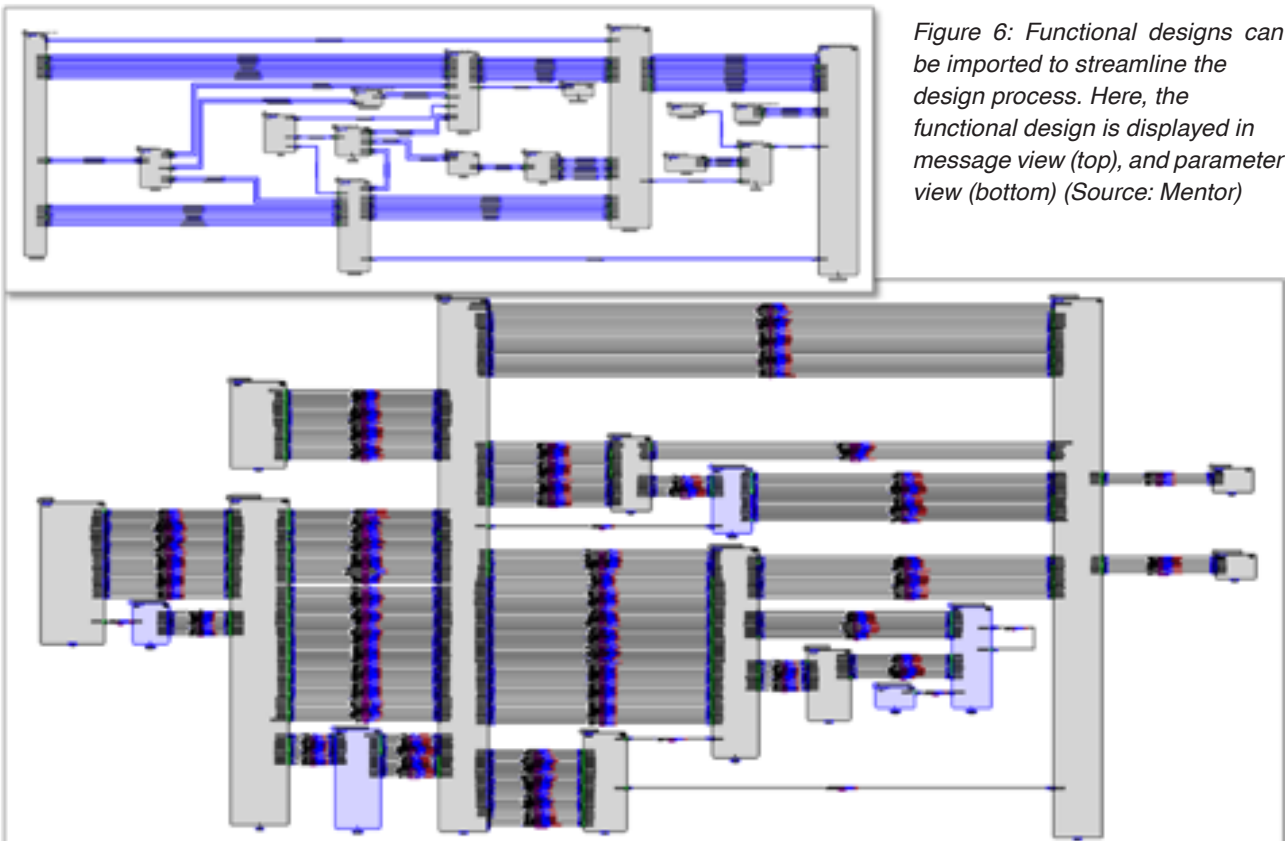

Figure 6: Functional designs can be imported to streamline the design process. Here, the functional design is displayed in message view (top), and parameter view (bottom) (Source: Mentor)

PC/CAN Interfaces

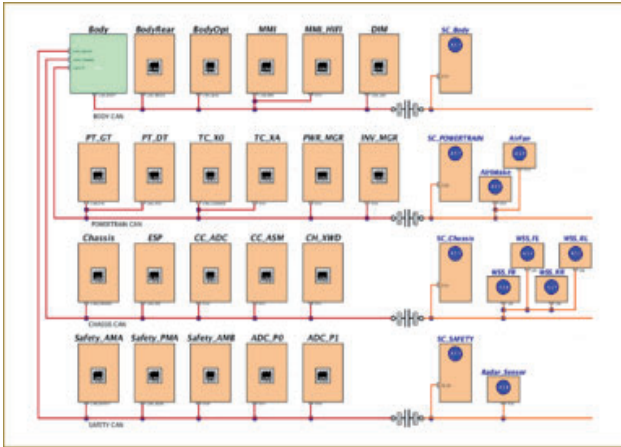

Figure 7: The logical design of the E/E system can be reverse engineered from existing logic models (Source: Mentor)

generate metrics that predict architectural performance and network reporting data that illustrates the system's behavior in terms of parameters and messages. With these analytics, engineers can identify optimizations to improve the performance of the architectural design, streamline the PG and SP mappings, and increase the network efficiency. Then, Capital can produce reports to communicate with suppliers, to configure test loggers, and to report or document the design for other customers internally or externally.

The design data can also be sent to the Capital Systems Networks solution to complete detailed Autosar design and network timing analysis. In Capital Systems Networks, engineers can begin designing the software implementation needed to enable the functions that have been assigned to each ECU. Within this environment, the engineers can also zoom in to look at diagnostics systems.

Capital provides the architectural design, functional allocation, and parameters to the topology. Each of these features interrelates through the software diagnostics network. Capital is able to extend this visualization and design of parameters and messages to other network types, such as Ethernet or CAN FD. The methodology also extends to

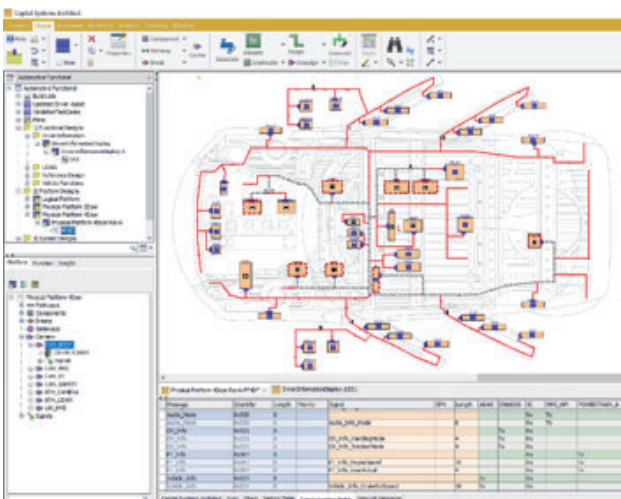

Figure 8: Capital enables engineers to reallocate functions around the vehicle architecture to optimize the employment of ECUs in the vehicle (Source: Mentor)



USB-to-CAN V2
1-2 x CAN (HS/LS)
also available for CAN FD

Easy CAN and CAN FD connection for your application

- Interface for your control or monitoring application as well as for the IXXAT tool suite
- All PC interface standards supported with one uniform driver interface
- Drivers (32/64 bit) for Windows7/8/10, Linux, QNX, INtime, VxWorks and RTX
- APIs for CANopen and SAE J1939



Discover more:
www.all4CAN.com



CAN-IB 100/200/PCIe
1-4 x CAN (HS/LS)
CAN FD available



CAN-IB 130/PCIe 104
2-4 x CAN (HS)
CAN FD available



CAN-IB 120/PCIe Mini
1-2 x CAN (HS)
CAN FD available



CAN-net NT 420 - Ethernet
PC-Interface, Bridge, Gateway
2 x CAN FD, 4 x CAN



CANblue II - Bluetooth
PC interface, bridge, gateway
1 x CAN (HS)

HMS Industrial Networks GmbH
Emmy-Noether-Str. 17 · 76131 Karlsruhe

+49 721 989777-000 · info@hms-networks.de
www.anybus.com · www.ixxat.com · www.ewon.biz





Figure 9: Capital integrates analytics into the design flow so that engineers can evaluate system features such as process loading, network bandwidth utilization, and more (Source: Mentor)

design in diagnostic messages for Diagnostics over Internet Protocol (DoIP).

Capital Systems Capture can take input from a variety of sources, including SysML & UML descriptions, Rational Doors & Rhapsody, and the Context System Data Management tool, to create the functional design of a communication network. The generated functional designs can then be automatically enriched with the J1939 parameters and

messages stored in the dictionary. With this enriched functional design, the engineer can then map this onto the architecture design, and begin refining the initial mapping using Capital's built-in metrics. The entire flow to this point can be iterated through to optimize bandwidth utilization, processing, harness weight and length. Next, engineers can use the design to generate the electrical systems logic design, network and software architecture, and multi-board PCB

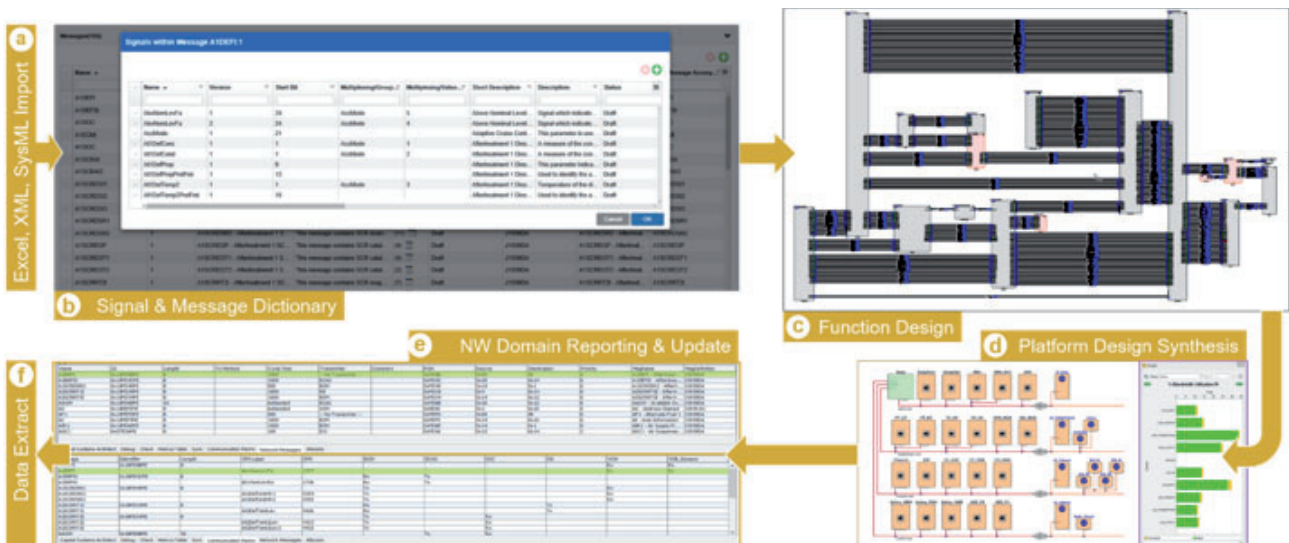

Figure 10: An overview of Capital's J1939 networks design flow (Source: Mentor)

designs to prepare for physical implementation. The finished designs can then be stored in Teamcenter (Figure 10).

Alternatively, this flow may begin by importing the SysML, UML, and other models directly into the Teamcenter Architecture Modeller. Using this input, Teamcenter can generate an analysis request that provides the necessary information to build the functional models in Capital System Capture. From here, the process proceeds as before by drawing J1939 parameters and messages out of the dictionary, enriching the functional design, mapping onto the architecture, and then iterating. The engineer then pushes the finished design back into the architectural model with all the metrics and data generated.

In summary, Capital Systems features built-in data coherency between the electrical design and implementation. This digital continuity fosters multi-domain and multi-disciplinary collaboration to reduce errors and improve design cycle times. Additionally, Capital enables rapid iterations to explore and evaluate different implementation options directly within the design environment with metrics to understand the technical and financial costs of implementing proposed changes.

Capital has now extended to integrate network and electrical system design. Capital Systems Networks expands the synthesis-driven Capital paradigm into network design. This enables engineers to reuse existing network design data to create a network dictionary such as for the J1939 specifications. Network design data can be directly implemented in the functional design. Then, a validated network design output can be synthesized from the electrical system architecture. Finally, teams can generate outputs to enable OEM (original equipment manufacturer) and supplier collaboration, reporting, testing, simulation, and for further optimization of the design in downstream flows.

The use of Capital tools for J1939 network design removes the manual file exchange and copy and paste tasks from system design for off-highway and commercial vehicles. Data consistency within the design flow assures a correct-by-construction design methodology. Engineers can rapidly assess the impact of proposed changes across the entire platform, reducing the risk of unknown consequences to the system design. Design data is stored in a database for re-use on future platforms, and downstream tools, removing repetitive and error prone tasks throughout the flow. Moreover, an integrated electrical, functional, and network design flow produces more accurate designs while increasing the efficiency of engineers for both near- and far-term projects.

Author



Hans-Juergen Mantsch
Mentor
info@mentor.com
www.mentor.com

CAN Repeater, Bridges and Gateways



NEW!
MQTT support for cloud connection and easy-&-fast programming using "Action Rules"

CAN@net NT 420
CAN-to-Ethernet gateway/bridge with 2 x CAN FD, 4 x CAN

Interconnect your CAN and CAN FD devices and systems

- Save costs due to simple wiring
- Increase your system reliability and protect devices by galvanic isolation (up to 4 kV)
- Backbone bus to set up multi-channel solutions
- Filter/conversion functionality – no programming!
- Bridging of large distances and easy system access using Bluetooth, Ethernet...



Discover more:
www.all4CAN.com



CAN-CR120/HV
Repeater for CAN and CAN FD
(4 kV galv. iso.)



CAN-CR110/FO
FO repeater for CAN and CAN FD



CANblue II – Bluetooth
PC interface, bridge, gateway



IXXAT CME/PN
Profinet-CANopen-Gateway



CANbridge NT
Bridge for CAN and CAN FD
with up to 4 channels

HMS Industrial Networks GmbH
Emmy-Noether-Str. 17 · 76131 Karlsruhe

+49 721 989777-000 · info@hms-networks.de
www.anybus.com · www.ixxat.com · www.ewon.biz



CAN FD core as an open source project

The Czech Technical University of Prague is developing a CAN FD core. It is intended to provide the core under open source conditions, but the implementer needs to negotiate IP rights in particular with Bosch.

The Faculty of Electrical Engineering (Department of Measurement) has designed in VHDL (Very High Speed Integrated Circuit Hardware Description Language) a CAN FD (flexible datarate) core. This development is intended to be shared under open source conditions. Volkswagen sponsors this project. The design has been tested on Zynx Zync and Altera FPGAs (field programmable gate array).

Once tested according to ISO 16845-1:2016, the VHDL model will be offered free-of-charge under MIT license. Nevertheless, the implementer has to negotiate IP rights. Especially, Bosch has some IP rights on the CAN FD protocol and its implementation. Students started this project. The current status of the IP core development is documented on [Github](#).

Modular IP core design

Each of the IP core modules has a unique functionality. The number of dependencies between modules is minimal, thus keeping modularity design rule. The whole system is implemented as synchronous design with asynchronous reset (assumed to be connected to an input pin of FPGA or ASIC). The CAN FD IP core is a memory-mapped peripheral. In order to be compatible with the university's Flexray IP core, the Avalon bus interface is used. The whole IP core is implemented with VHDL 2008 version of the language (it also complies with 2002 version).

The core is accessible via the Avalon parallel bus by Altera. The bus consists of separate write/read data lines. Read and write cycles are distinguished via dedicated signals. Avalon address bits 19 to 16 must be matching the core-ID value during the access. With this architecture, it is possible to run up to 16 instances of the IP core on a single Avalon bus.

The whole core is synchronized to one clock signal. Any other time-period is derived from this clock. Every register has an asynchronous reset by default. The design is intended to be latch-free. Input signals of the Avalon bus interface and the time-stamp value are expected to be synchronous to the clock signal and no clock synchronization is implemented on these signals. The CAN_RX signal is synchronized by simple synchronization chain with two flip-flops. This synchronization chain is optional, but it is recommended to use it, unless synthesis tools automatically insert synchronization chain.

The functional blocks shown in Figure 1 are separate VHDL entities and are implemented in stand-alone files. The CAN controller core consists of several sub-blocks. The

CAN FD protocol core shown in Figure 2 covers the functionality of serial data transmission according to ISO 11898-1:2015. Storing frames to be transmitted, storing received frames, transmission, reception, arbitration, bit stuffing, bit de-stuffing, CRC calculation, error handling, and fault confinement are implemented in this module. Furthermore, valid CRC selection, transmit trigger, and receive trigger multiplexing, status bus assignment and bus traffic measurement are implemented in this core.

There are by default three filter masks or one range filter to select, if this CAN FD data frame is to be stored or not. The receive buffer is a FIFO memory. The receive buffer can store received data frames with a length of 5 to 20 (32 bit) words. Therefore, if size of less than 32 words is used, long CAN FD frames won't be stored and data overrun will appear, even if the buffer is empty. Data overrun occurs always when there is less free memory in the buffer as size of the received data frame.

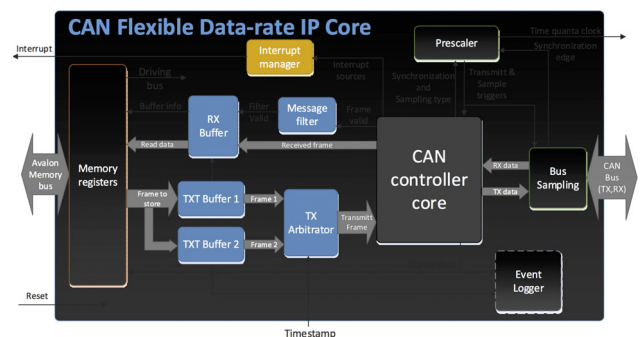

Figure 1: Block diagram of the CAN FD IP core (Source: Czech Technical University of Prague)

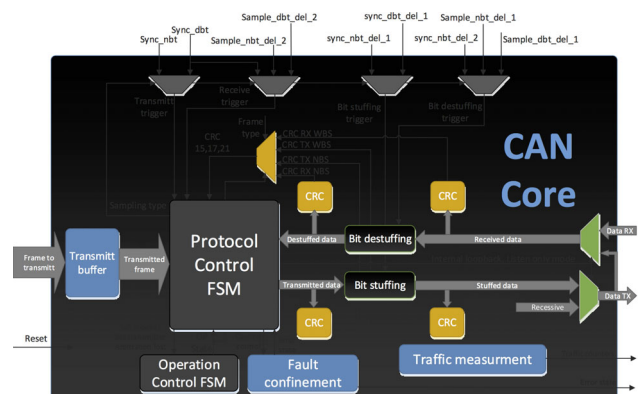

Figure 2: Block diagram of the CAN FD protocol core (Source: Czech Technical University of Prague)

In the transmission path, there is a TX arbitration circuitry. It manages the two implemented transmit buffers. Additionally, it implements the functionality of propagating a frame to the CAN FD protocol core at a specific time. If external time-stamp value is lower than time-stamp specified in a frame, then a data frame is propagated to CAN Core. If time-stamps in both buffers are lower than external time stamp, then the one with the lower time-stamp is propagated to the core for transmission. When both time-stamps are the same and lower than external time-stamp, the frame with lower CAN-ID is propagated to the output. If both timestamps are equal and both CAN-IDs are equal, then frame from TX buffer 1 is propagated. Additionally, the circuitry can be configured to forbid propagation from each of the TX buffers.

The CAN FD IP core provides an interrupt manager. The interrupt sources are configurable. Every interrupt is marked into an interrupt vector. If another interrupt source is activated when an interrupt is active, no further interrupts are produced on the output, but the interrupt source is accumulated into interrupt vector. Thus one active period, there can be managed a superposition of up to 11 interrupt sources going active. It is recommended that the low-level driver always reads interrupt vector after an interrupt is detected, to determine the events that caused the interrupt. Interrupt manager can be configured to forbid or allow various interrupt sources.

Summary and outlook

The project at the Czech university is still under development. In particular, additional testing of the IP core is necessary. This includes implementing event logger and error detection feature tests.

The current CAN FD IP core has many features, which are not required by CAN FD standard. However, there is room for improvement. Following list names just a few of the possible improvements:

- ◆ Automatic bit rate detection, either as part of core or separate module. Once this unit is turned on, it measures bus timing (e.g. over several data frames) and provides the results, or sets the bus timing registers.
- ◆ Additional state machine, which decides about usage of bit rate based on relative error rate of two bit rates.
- ◆ Optimization of TX buffers to be synthesized into RAM elements, not to LUTs.

Of course, the project team appreciates further sponsors as well as partners for conformance and interoperability testing. ◀

Author



Holger Zeltwanger
CAN Newsletter
pr@can-cia.org
www.can-newsletter.org

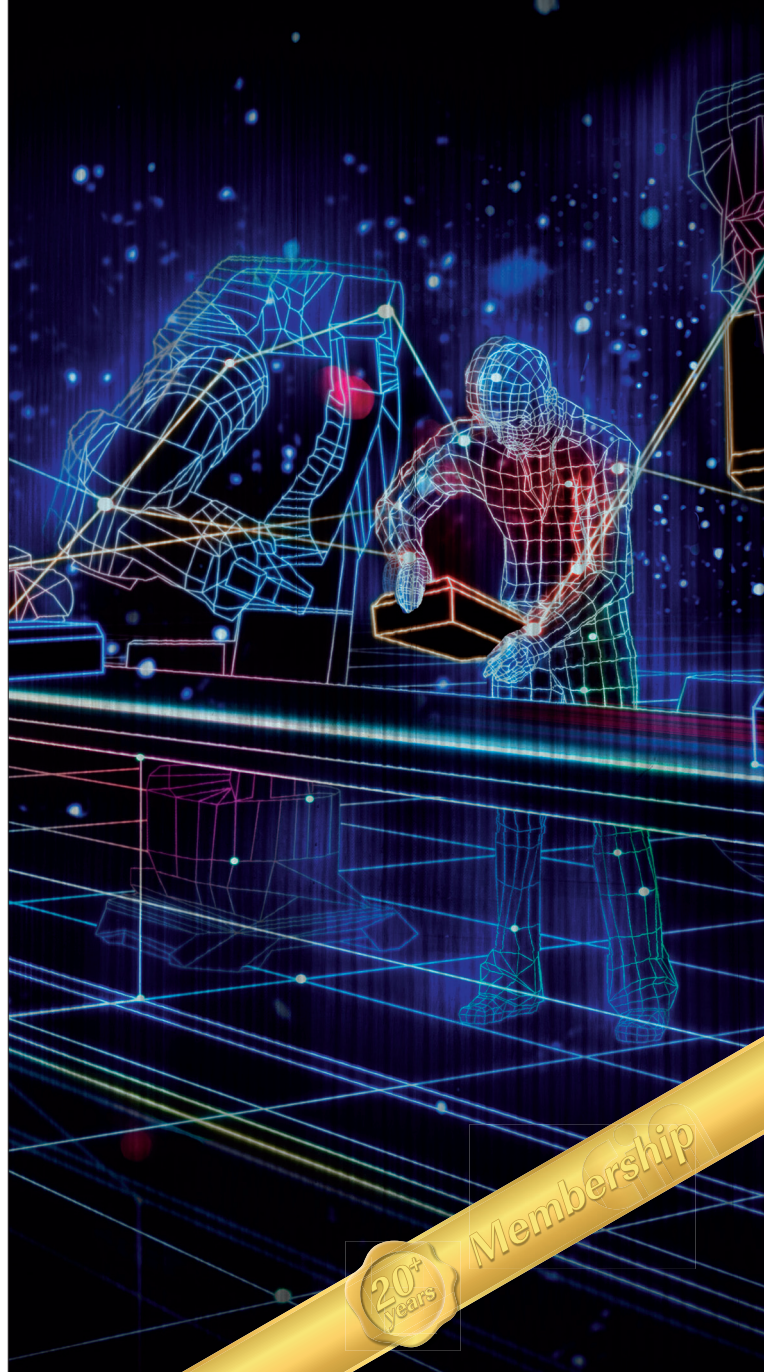

WORLD SWITCHED ON

Switching on connections for greater human productivity

Think of a world with more time to dream big. With autonomous production, intelligent factories will free us humans to focus on that next innovation. End-to-end semiconductor solutions from Renesas provide safe and secure sensors, drives, networks, and controls – with entire software packages – putting intelligence into endpoints throughout production facilities to raise productivity and consume less energy. Improving the world through innovation and productivity is what a smart factory is all about. Ask us about this world.

CANopen used in medical systems



The CANopen devices from HMS/Ixxat are used in a range of medical application fields. This article describes one and gives a little throwback.

Figure 1: The Econ100 used for mammography (Source: HMS/Ixxat)

The history of CAN and CANopen in medical technology goes back many years. As early as 1992 the company Philips Medical Systems recognized the advantages of the CAN technology and developed a protocol for use in their medical tables and X-ray systems. This first approach, the CMS protocol, served in the following years as a scaffold for the CAL protocol specified by CAN in Automation which ultimately found its fulfillment in today's CANopen protocol.

The advantages which result to device manufacturers through the use of a bus system, are easily recognizable considering that modern medical equipment nowadays consist of a number of modules that must be connected to a functioning overall system. Individual system components, such as X-ray generators, patient tables or injectors can – with the use of a standardized bus system – be independently developed, modular connected and controlled from a central point. This saves development costs and enables the universal and scalable deployment of components in different systems. It also reduces the number of cables to a considerable extent.

A decisive advantage of CANopen as the communication protocol is the availability of profiles for a variety of medical devices, which ensure the interoperability of the components in an easy way. Due to the nature of CAN, CANopen provides a very high error robustness, short waiting and error-recovery times, a robust data transmission, a variety of possibilities for the modularization of systems and networks, plug-and-play support and standardized system services. Furthermore, the CAN and CANopen technology already is approved by TÜV Germany and the FDA in the US for use in medical systems, since here a number of approved applications are using this technology.

To enable a computer to control medical tasks, the computer must be able to communicate with the CAN/CANopen modules in use. The PC/CAN interfaces from HMS meet the electrical requirements according to IEC 60601-1 and enable the connection of PC-based applications to CAN-based networks. In addition, HMS offers several CANopen driver packages for Windows. For example, by using the Ixxat CAN cards together with the Ixxat CANopen Manager API, medical devices can be controlled via a PC. Also, medical data can be imported for further evaluation. The Ixxat CANopen Manager API also supports the CiA 425 application profile, which allows automated integration of components into complete systems. The CiA 425 application profile allows easy connection of injectors for contrast media to control computers for CT systems. The control computer with the Ixxat CANopen Manager API detects the connected devices and their position in the network, and can automatically configure and control the entire system.

Figure 2: As in many machines, the moving parts of the Giotto Class is mainly controlled using the CANopen protocol (Source: HMS/Ixxat)

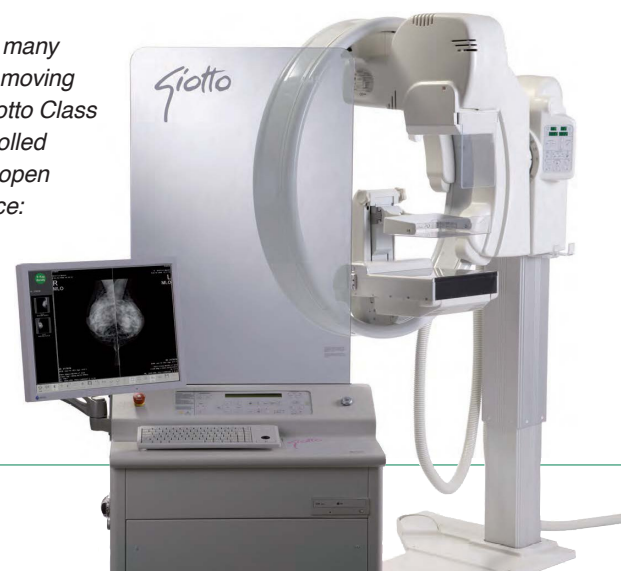

In this context, it is particularly interesting that the CT system is frequently supplemented with components – e.g. Injectors – from third parties (3rd party vendors) without impairing the reliable functioning of the overall system. There are many other applications. Various well-known providers in the field of medical technology and laboratory automation rely on the proven quality of CAN/CANopen products from HMS. As an example, Ixxat CAN interfaces or Ixxat control PCs with Ixxat CANopen software are also used in automatic mammography devices.

Mammography

IMS uses the Ixxat Econ100 embedded controller to control movement, X-ray emission, data acquisition, visualization, and safety chain in their Giotto Class mammography machine. This advanced machine can move around the patient taking X-ray photos from several different positions, providing physicians with better pictures for detecting breast cancer at an early stage. The Giotto Class can also be used for stereotactic and tomo biopsy examinations which further increases the importance of reliable and fail-safe motion control.

As in many machines, the moving parts of the Giotto Class is mainly controlled using the CANopen protocol. “The Ixxat Econ100 is the brain of Giotto Class system,” said Paolo Vignoli, Research and Development Manager at IMS. “It is the master for the internal communication network and the logic control unit for about twenty different electronic boards. It controls movement, X-ray emission, data acquisition, visualization, and safety chain inside the machine. It also controls the biopsy accessory ‘Smart-finder’ when it is plugged in to the system.”

The controller features a Xilinx Zynq SoC – dual-core Cortex A9 processor as well as two CANopen ports which make it possible to configure communication at two different speeds – to adjust to different stub lengths within the network. “The Econ100 offers two independent CAN networks with CANopen standard and meets our demands for a four millisecond cycle time – this was very important for us”, explained Paolo Vignoli. ◀

cw

based on information by HMS/Ixxat

CAN Newsletter Online: Other applications using CAN



Predictive road-condition **Supplementing by CAN in-vehicle data**

Bosch plans to combine CAN in-vehicle data with information provided by cloud services. This should improve the road-condition predictions.

[Read on](#)



PSA partner program **Using true CAN data from PSA cars**

The French carmaker has revealed the Free2move program, which includes the Peugeot i-Cockpit, an app displaying also some CAN data.

[Read on](#)



Electric zero-emission truck **Control network is based on J1939**

Many of the ancillary systems that are traditionally driven by the engine were also electrified, including the air compressor, power steering, and HVAC system. The controls were integrated into the vehicle’s J1939 network.

[Read on](#)

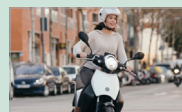

Electric moped **Rental program in New York**

Electric scooter share programs are on hype in U.S. cities. In Brooklyn, New York, Revel Transit offers 68 e-mopeds by Tarrot (Spain) with a CAN diagnostic interface.

[Read on](#)



Autonomous driving **Vending vehicle with robot making coffee**

The Chinese start-up company Pix has developed a self-driving vehicle that implements an embedded CAN network.

[Read on](#)



Advanced driving **Using human voice warnings and CAN**

EVoice enables the recording in advance of up to 100 warnings in the driver’s native language, that are adapted to various problematic behavior patterns on the road. The EFlash SF driver warning device uses flashing icons to warn the driver of dangerous behaviors.

[Read on](#)

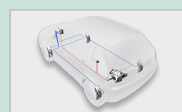

Rear-axle transmission **For off-road and sports vehicles**

Recently, ZF has introduced the next generation of electronic limited slip differential (eLSD). The heart of this improved active rear axle drive is a control unit that meets cyber-security standards for software updates via the cloud.

[Read on](#)

Integrating absolute encoders simplifies machine design



(Source: Schneider Electric)

With the ongoing trend of integrating more devices into single units, the addition of absolute encoders can eliminate sensors and reduce machine startup time, increasing efficiency while lowering costs.

Schneider Electric provides its CANopen-connectable Lexium MDrive motor products with integrated multi-turn absolute encoders for rotary and linear motion. These compact all-in-one motion units are designed and assembled in the USA. The encoders are used for control and feedback purposes across a wide range of applications including industrial, packaging, and medical systems.

Incremental versus absolute encoders

Incremental encoders determine relative position by generating a pulse each time an increment, or line, is reached. Simple and inexpensive, these encoders are also limited, require sensors, and only provide change information. Optical incremental encoders function by having a contactless optical sensor read the markings on an encoder wheel: the opaque lines and transparent spaces between. The number of lines per revolution defines the encoder's resolution.

Magnetic incremental encoders, compared to optical, offer several advantages including smaller size, increased accuracy, and robustness. These devices use magnets and sensors placed around the edge of a wheel to detect movement and position. The number of north-south poles (magnets placed on opposite edges of the wheel) and magnetic sensors define the encoder's resolution. Absolute encoders can be single-turn or multi-turn sensors. Single-turn encoders measure displacement in one turn from a starting position across 360 degree. Multi-turn encoders measure this way as well, plus additional tracking of the total number of revolutions through unique codes assigned each shaft position.

Historically, optical absolute encoders have been mechanical devices using an optical code wheel and gearing to record positions. Absolute position is determined by the binary values coded on the wheel, read by passing light through the openings.

Magnetic absolute encoders use a magnetic sensor array similar to an incremental magnetic encoder, but are connected to circuitry for position encoding, multi-turn counting, position storage, and backup voltage monitoring. These encoders are typically smaller and lower cost than optical options.

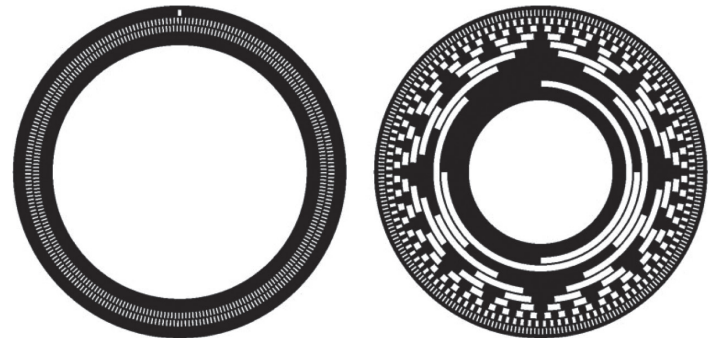

Figure 1: Encoder wheel representations highlight the difference of how positions are indicated between an incremental and an absolute encoder (Source: Schneider Electric)

From the user's perspective, the technology behind an encoder is less relevant than the performance that can be achieved. The key performance difference between incremental and absolute encoders, is retention of position information by absolute encoders even when a system is without power.

In application, absolute encoders are best, if a particular setting must be recognized and available after a planned or unplanned system shutdown. They provide unique position values as soon as they are switched on by scanning the position of a coded element. Even movements that occur while there is no power are recorded into accurate position values, once the encoder is turned on again. This feature eliminates the need for external sensors and a lengthy homing routine. ▶

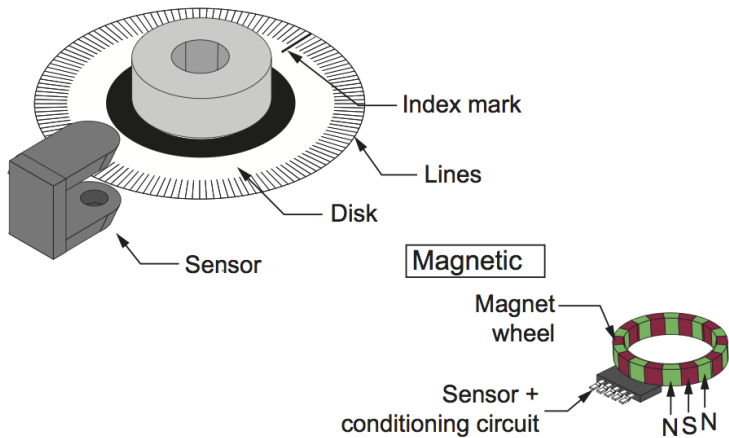

Figure 2: Incremental encoders are typically less expensive than absolute encoders, with two types available: magnetic and optical. The magnetic is smaller, which can reduce impact on a product's footprint (Source: Schneider Electric)

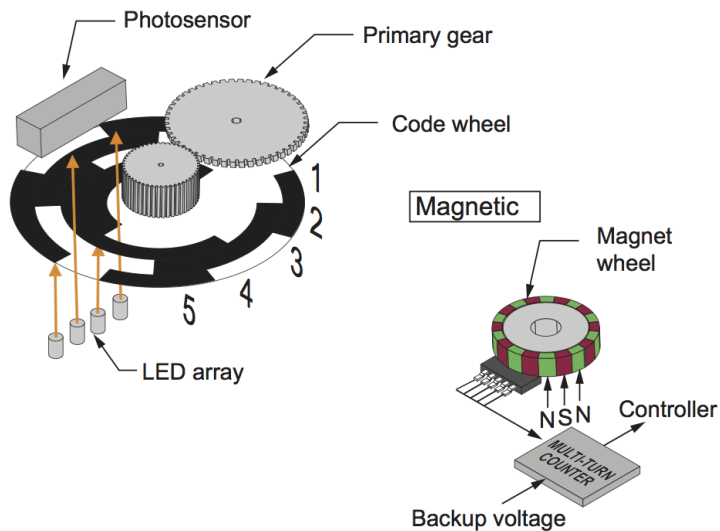

Figure 3: Absolute encoders benefit users by recording unique position values, whether or not a system is powered. This eliminates the need for external sensors and re-homing after planned or unplanned shutdowns (Source: Schneider Electric)

Magnetic absolute encoders are typically smaller and more favorable than optical absolute encoders. An additional advantage of magnetic absolute encoders is their support of special closed-loop functionality. Absolute encoders benefit users by recording unique position values, whether or not a system is powered. This eliminates the need for external sensors and re-homing after planned or unplanned shutdowns.

Open- versus closed-loop systems

Open-loop systems, or systems with an incremental encoder, only measure what direction and how far a motor traveled. Any power interruption, planned or unplanned, will require a homing routine to calibrate the system at startup. The simple reason is that, until the controller knows exactly where the load is positioned, it cannot begin normal operation.

CAN YOU IMAGINE THE POSSIBILITIES? WE CAN!

CANopen®



Now even more capacity with the 2nd generation



The PFC200 Controller from WAGO – Our Most Powerful Line of Controllers

- High processing speed
- Programmable with e!COCKPIT (based on CODESYS 3)
- Configuration and visualization via Web-server
- Integrated security functions
- Robust and maintenance-free

www.wago.com/pfc200



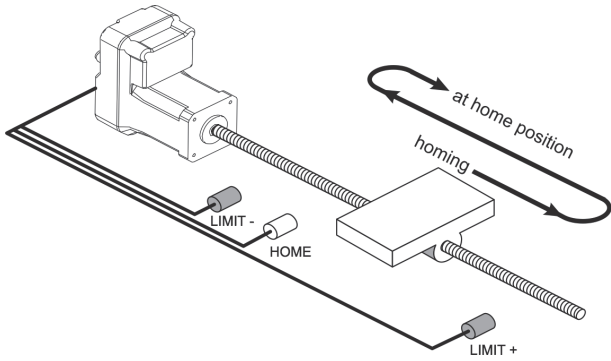

Figure 4: Open loop system with incremental encoder with typical homing sequence with linear motion axis, using one home and two limit sensors (Source: Schneider Electric)

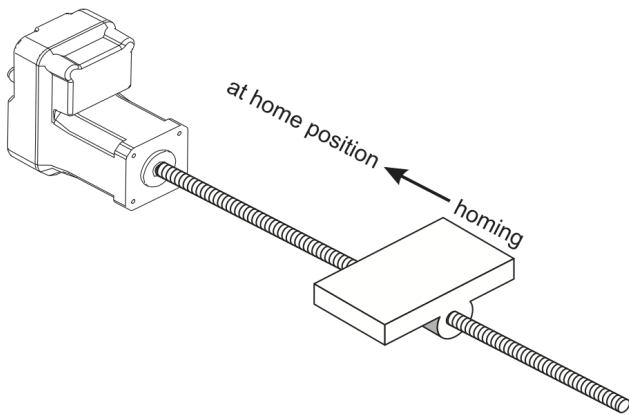

Figure 5: Closed loop system with absolute encoder: typical sensor-less homing with linear motion axis (Schneider Electric)

When powered on, a machine begins its startup routine: the electronics initializes, then motion axes begin the homing process by slowly moving between limit sensors before settling on the home sensor. In a multi-axis machine, that time will only be as fast as the slowest axis takes to home.

In applications sensitive to time and motion, an unplanned homing execution could lead to failure and loss of samples. An example would be a sample analyzer using costly, short lived reagents. This same application in a closed loop system with absolute encoder reduces the risk of failure. When power is applied, operation can start right where it stopped, as that precise location is known. If returning to home is desired, this can be achieved more rapidly without searching for sensors.

Saving time and money

Without the need to perform a homing routine on startup, closed-loop systems with absolute encoders can save significant time. Faster machine startups can increase system productivity. As an example, hours of production time can be gained by operating a bottle capping machine as a closed loop system that does not require homing routines at startup. If the slowest axis of an open loop bottle-capping machine takes 45 s to home at startup each weekday, lost productivity per machine adds up to almost 4 hour/year. Or, at 5 s each, some 2700 additional bottles

that could be capped, multiplied by the number of operational machines.

Designing an absolute encoder based system can eliminate three sensors, the wiring from three sensors and the design and labor overhead needed to install, harness, and maintain three sensors. With photo or proximity sensors that savings can be substantial, especially when measured across multiple axes. With mechanical switches, the costs are less, but mechanical contacts degrade and can fail over time.

Cost savings primarily derive from the material and labor costs associated with developing and deploying elaborate harnesses, associated conduit and mounting hardware to support the sensors. Additional cost savings can come in the form of reduced downtime due to maintenance. ◀

hz

based on information by Schneider Electric



TTConnect Cloud Service

TTControl Cloud Service enables manufacturers of off-highway machinery, fleet owners and end customers to access machine data from the office, at home or on mobile devices.

The solution includes an easy to operate and intuitive cloud platform with a customizable front end PC-software, connectivity and a ruggedized hardware (IoT gateway) for a true end-to-end machine management solution.

The IoT gateway, TTConnect Wave, supports the industry standards CAN and Ethernet and additionally provides wireless and cellular interfaces to communicate with the cloud platform.

Smart battery sensor with CAN interface

The MM9Z1_638 by NXP is an integrated battery monitoring system. It features CAN and LIN 2.2 connectivity.

(Source: Fotolia)

The integrated circuit (IC) supports current measurement via an external shunt resistor. The chip features four voltage measurements via internal calibrated resistor dividers or external dividers. It includes an internal temperature sensor, allowing close proximity battery temperature measurements, plus four external temperature sensor inputs.

One implemented 16-bit Sigma-Delta analog/digital converter senses the current. The converter input is connected to the output of a programmable gain amplifier (PGA) with four different gains. The PGA gain selection can be either user selectable or automatically selected. The user can choose, which gains are used by the automatic selection. The converted value available in the output register has a fixed value, independent of the selected gain. The output value is a signed value available on a 24-bit range register. The external shunt value can be selected from one of the following values: 50 $\mu\Omega$, 75 $\mu\Omega$, 100 $\mu\Omega$, 150 $\mu\Omega$, and 200 $\mu\Omega$.

The sensor IC features a battery voltage measurement with one 16-bit second-order Sigma-Delta analog/digital converter. The converter input is connected to the output of a multiplexer allowing selection of voltage sense with an internal resistor divider or a direct voltage sense. The voltage and current converters are synchronized.

There is also a third 16-bit Sigma-Delta analog/digital converter for temperature measurements. Its input

is linked to the output of a multiplexer, which allows selecting the internal temperature sensor or the external sensors via the direct voltage sense.

Each of the three A/D converters has its own set of registers for offset and gain compensations. The user can access and use these to enhance system performance, taking into account external components.

These peripherals are connected to the integrated S12Z central processing unit (CPU) by means of a die-to-die initiator (D2DI), which represents the communication interface to the companion (analog) die. It offers 128 KiB of flash memory and 8 KiB of SRAM. Additionally, there are up to eight general-purpose inputs and outputs

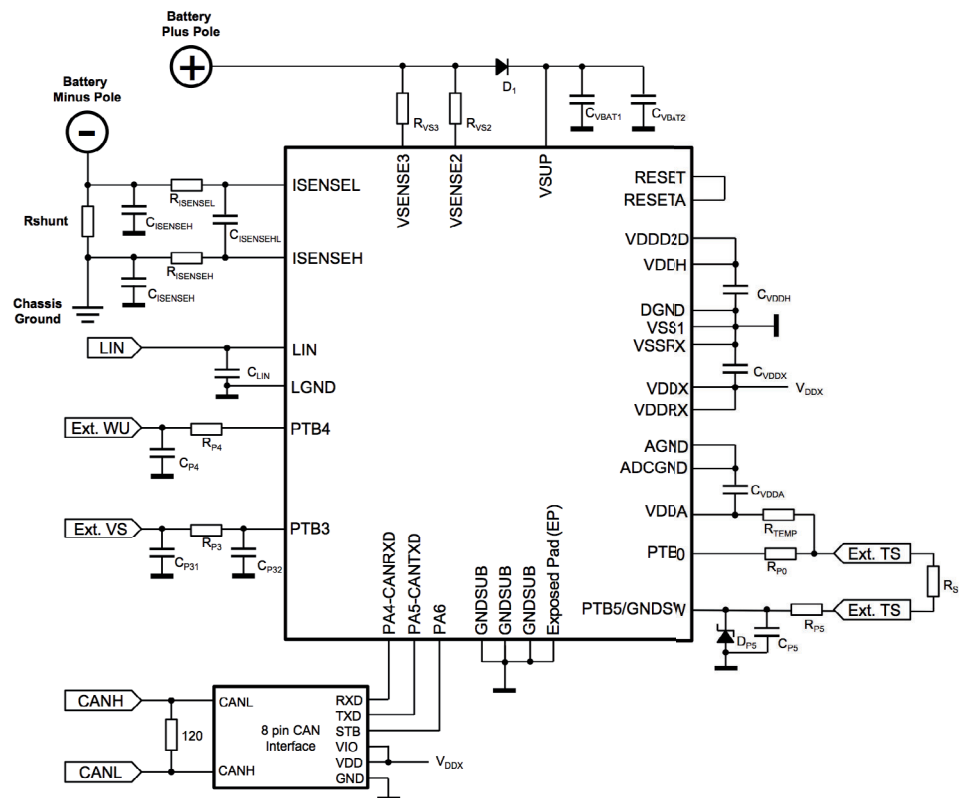

Figure 1: Typical application of the smart sensor controller with an on-chip CAN module, to connect it to the CAN network just a CAN transceiver needs to be added (Source: NXP)

(GPIO) as well as one Serial Peripheral Interface (SPI) port. The CPU also features an interrupt module and debug-capabilities via the on-chip debug module (DBG) in combination with the Background Debug Mode (BDM) interface.

The chip is optimized to monitor automotive 12-V starter batteries, but can also be used in other battery monitoring applications, like UPS (uninterruptible power supplies) or emergency/backup supplies (as are used in elevators, and so on).

Some CAN interface details

Besides the [LIN](#) interface, the IC features an on-chip CAN module. This CAN controller is based on the MSCAN implementation. It overcomes priority inversion problems and complies with the ISO 11898-1:2003 standard. This means it supports the Classical CAN protocol with 11-bit and 29-bit CAN-ID data frame formats. Bit-rates up to 1 Mbit/s can be configured. The CAN module features five receive buffers with a FIFO storage scheme and three transmit buffers with internal prioritization to avoid priority inversions. The CAN implementation allows aborting of not yet transmitted data and remote frames.

The module provides maskable ID filter supporting two 32-bit masks, four 16-bit masks, or eight 8-bit masks, programmable wake-up functionality (with integrated low-pass filters). The loop-back mode enables self-test operation and the listen-only mode can be used for monitoring the CAN network. Other features include programmable bus-off recovery functionality and separate signaling and interrupt capabilities for all CAN receiver and transmitter error states (warning, error passive, bus-off). The Transmit Error Counter (TEC) and the Receive Error Counter (REC) are readable. There are internal timers for time-stamping of received and transmitted frames. The CAN module has three low-power modes: sleep, power-down, and MSCAN enabled.

Diagnostic features

The MM9Z1_638 provides self-diagnostics. This includes the CPU functions, the analog die, and some application-specific features. Diagnostics during runtime is achievable by connecting a known signal to the input of the acquisition channel, performing an acquisition and comparing the result against the expected value. This has to be performed for each of the three acquisition channels, individually. The expected value varies from device to device, therefore a device-specific diagnostic value is measured during final test of the device, and is stored in non-volatile flash memory of each device.

Literature

- [1] MM9Z1_638D1: Intelligent battery sensor with CAN and LIN (2016-11, Revision 5.0)
- [2] AN5299: MM9Z1_638 diagnostic features (2016-07-14)

hz

www.can-cja.org

Industrial Ethernet Gateways/Bridges

**CAN/CANopen
EtherCAT
PROFINET
CAN-to-Cloud**



CANopen

**PROFI
NET**

EtherCAT

CAN-EtherCAT

- Gateway between CAN/CANopen and EtherCAT
- Additional Ethernet interface for EoE

ECX-EC

- EtherCAT slave bridge
- Process data exchange between two independent EtherCAT networks
- DC synchronization between EtherCAT masters

CANopen-PN

- Gateway between PROFINET-IO and CANopen
- PROFINET-IRT capable
- Simple configuration via S7 manager or TIA portal

CAN-to-Cloud

- Easy connection of CAN networks to the Microsoft Azure Cloud
- Control of CAN networks
- Control the CAN network from anywhere in the world

Besuchen Sie uns auf der
sps ipc drives



**Nürnberg 27.-29.11.2018
Halle 5, Stand 131**



esd electronics gmbh
Vahrenwalder Str. 207
30165 Hannover
Germany
Tel.: +49-511-3 72 98-0
info@esd.eu
www.esd.eu

US office:
esd electronics, Inc.
70 Federal Street - Suite #2
Greenfield, MA 01301
Phone: 413-772-3170
us-sales@esd-electronics.com
www.esd-electronics.us

Optimizing CAN bit configuration on robustness

This article describes an approach on how to get your CAN system robust according to the knowledge provided.

In most serial communications, for example USB and Ethernet, bit-configuration is fixed or performed automatically. This simplifies the use of the communication standard, but also puts constraints on the cable-length, cable-quality, oscillator tolerance and the signal transceiver in use. CAN was designed to be robust, even for a cost-optimized physical layer;

1. Low-cost oscillators -> low tolerance oscillators.
2. Low-cost twisted pair or even a single wire -> large impedance variations.
3. Any cable length -> signal loss, causing lower signal to noise ratio and delays.
4. Low-cost cable driver, like a transistor -> long delays and variations in the driver delay.
5. Real-time performances known and guaranteed -> delays will limit the bit-rate.
6. Functional in a tough electrical environment -> large variations in amplitude and edge location.
7. Functional across a wide temperature range -> large variations in impedance and delays.
8. Functional in a rough chemical environment -> large impedance variations.

All the constraints listed above will cause variations and demands on the edges and the amplitude in each bit. However, by configuring the CAN bit, it is possible to protect the sample point to ensure that the communication is as robust as possible for a specific environment.

If the CAN bit-rate and the CAN bit configuration are predefined in some way, it results in constraints in all the parameters listed above, resulting in a less robust communication. Some of the parameters such as cable length, oscillator tolerance, and delays can be found in the oscillator and CAN driver data sheets and specifications. Other parameters such as EMI (electromagnetic interference) and changes due to temperature and ageing must be predicted. It is almost impossible to test all possible variations

that could exist in the environment over the lifetime of the system. The best solution is to find a sample point most protected from expected variation in the future. Normal sampling of the bit is done at the center of the bit to ensure that the sample point is as far away from the edges at both ends of the bit to be sampled (Figure 1)

The sampling is synchronized to the first edge received (A1) and the sampling of the bit is relative to this edge at B1. If the transmitter of the frame has an oscillator that is faster than the receiver, as shown in Figure 1, the edge shifts a little to the left for every bit (time) that passes, compared to the location of the edge at A1, C1, D1, and G1.

After several bits, the edge reaches the sample point and the sampling takes place in the wrong bit. To solve this problem there is a resynchronization mechanism within the communication. When the edge is detected to be outside of the sync-segment (D1), the receiver adjusts the bit-length by removing as many time quanta as necessary to put the edge in the sync-segment. In this case, one TQ (time quantum) is removed in the propagation segment at (E1) to get a better sample location at (F1) and the edge is now located in the sync-segment G1. From this it is obvious that the phase-segments around the location of the sample point must be large enough to ensure that oscillator difference phase shift does not reach the sample point. It should also be obvious that SJW, defining the maximum number of TQ (time quanta) that can be removed, is large enough to allow necessary adjustment. On the other hand, SJW should be as small as possible to ensure that other random phase shifts do not result in over-compensation.

If the transmitter of the frame has an oscillator that is slower than the receiver, the edge shifts a little to the right for every bit that passes. If the signal is exposed to noise, for example under an EMC-test, the noise also introduces a phase shift in time that is closely related to the

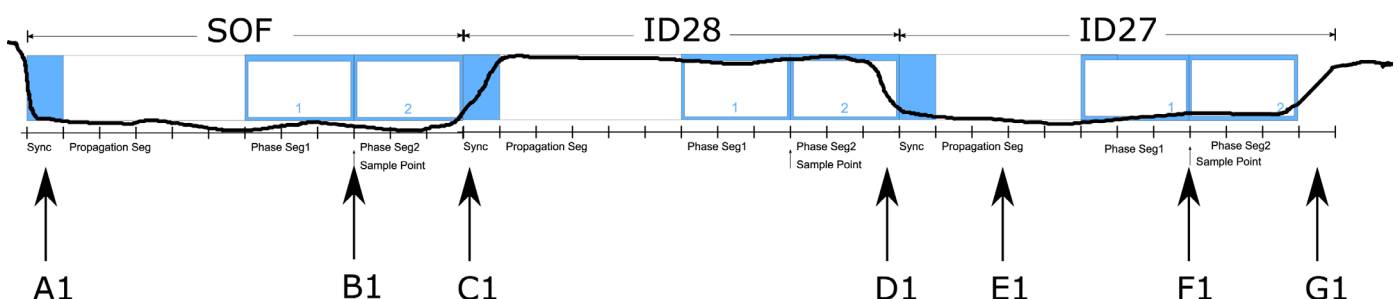

Figure 1: Alteration of phase shift due to oscillator tolerance by adjusting the number of time quanta (Source: Kvaser)

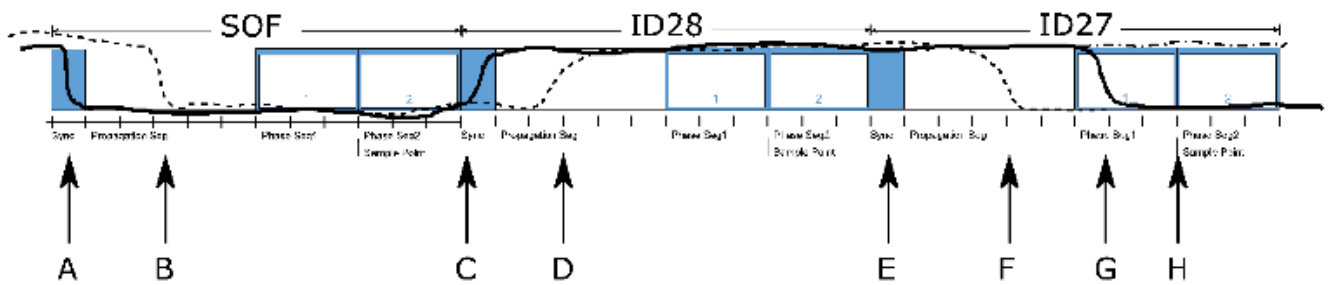

Figure 2: A 'worst case' phase shift due to arbitration (Source: Kvaser)

radiated energy. A bit short in time (high bit-rate) is more sensitive than a long bit because this edge variation will take a greater part of the bit short in time.

Protecting sample point from phase shift

In CAN, the signal is either electrically forced to a dominant (0) or passively restored to recessive (1) by the ending resistor. This typically provides a well-defined edge when the bit level changes from recessive to dominant. The edge from dominant to recessive is restored by discharging the stored charges connected to the bus-line in the ending resistors. If the CAN network is long, with many installed units, this discharge could be considerable, resulting in a delay in the switch from a dominant to recessive state. The resulting phase shift (delay) of the dominant to recessive edge must be considered when protecting the sample point. The problem with oscillator tolerance is the same for any bit-rate but the phase shift due to the passive switch from dominant to recessive has a fixed value in time

and the effect of this part increases when the bit-length becomes smaller at a higher bit-rate.

CAN is a multi-master communication which allows any unit to start sending as soon as the communication media is idle. If more than one transmitter starts a CAN frame, the collision is solved by arbitration. Arbitration demands that all units sample each CAN bit, one by one, and evaluate each bit, one at a time. At the start of the CAN frame, in the arbitration section, the sender with a lower priority level is excluded from transmitting the complete CAN frame. Figure 2 shows why this arbitration could result in a large phase shift. To simplify the description in this example, only two units are involved in the arbitration. The two units are located at the ends of the CAN cable, with the longest possible signal delay. In CAN, any unit can start sending when there is no communication i.e. the CAN network is idle. The first unit starts to send the first bit (SOF-bit) at A and this edge propagates down CAN and reaches the other end at B.



Making mobile machines perform
Efficient | Safe | Green

Interconnect your Innovations!



TC3G

Connectivity and data management platform

- Licence-free Linux operating system
- STW Telematics Application Framework
- machines.insight for configuration and machine analysis
- Gateway, edge computing and logging functionality
- 2G/3G, GPS/GLONASS, WLAN/BT

Visit us at these fairs:



SPS/IPC/DRIVES, Nuremberg
27.11. – 29.11.2018, Hall 7, Booth 150



bauma China, Shanghai
27.11. – 30.11.2018, Hall N2, Booth 643



Up to this point, the CAN network is considered idle by the other unit, so this unit starts a CAN frame at B. This first bit in a CAN frame is always dominant and, in this case, the first arbitration bit is recessive. The first unit switches recessive at C and the second unit does this with the delay at D. The ID27-bit in the first unit is recessive and keeps the recessive level at E. The second unit has a dominant ID27-bit and makes the CAN network dominant at F. This dominant edge propagates back to the first unit and makes the CAN network dominant at the first unit at G. The propagation segment should be large enough to keep the phase shift due to propagation delay within the propagation segment. In the example above, the second unit has an oscillator that is slower than the first unit and this phase shift adds to the phase shift caused by the propagation delay, causing the edge to reach some distance into phase segment 1. This is not a big problem because the resynchronization mechanism described in Figure 1 adds in TQ in the propagation segment and moves the sample point at H further back in time.

Achieving the correct bit-setting

There are some basic rules to follow to simplify CAN bit configuration. Those rules can be divided into five different areas.

1. The oscillators and their parameters used in different units connected to the CAN network.
 - a. High tolerance oscillators simplify the configuration and increase system robustness.
 - b. An identical oscillator frequency in all units simplifies the configuration and makes the system more robust.
2. The CAN drivers, which have different delays and capability to shape the signal.
 - a. CAN drivers with low delay permit more bit-time to be used for cable delay or to protect the sample point against phase errors.
 - b. CAN drivers with low variations in the delay reduce the risks created by temperature and ageing.
 - c. CAN drivers with good signal forming reduce phase errors.
 - d. CAN drivers with good signal shaping reduce EM-noise from the CAN.
3. EMC filters, which introduce a capacitive and inductive load that reshape the signal.
 - a. If possible, do not use EMC filters between the CAN driver and the CAN network.
 - b. If EMC-filters are used, select devices with low capacitance and inductance, to minimize the amount of energy stored.
4. The length of the drop-lines, from the main bus-line to the units.
 - a. Each cable segment holds capacitance and inductance, which affects the signal. To minimize the effect, make the drop-lines as short as possible.
5. The length of the CAN network.
 - a. Long cables cause long signal delays, which limits the arbitration bit-rate.
 - b. Long cables cause a voltage drop, due to resistive loss.
 - c. Long cables can pick-up more EM-noise.
 - d. Long cables can transfer more EM-radiation.

How to select oscillators

1. If using oscillators with better than 100 parts per million stability, then all accumulating errors can be ignored.
2. Use the same oscillator frequency in all modules to ensure that the same settings are applied to all modules. This ensures that no phase errors are introduced due to the bit-configuration.
3. If using different oscillator frequency in different units, ensure that the relationship fulfills the following equation: $osc_x/Mx == osc_y/My$, where Mx and My are integers. (for example if $osc_x = 12$ Mhz and osc_y is 25 MHz, the smallest possible integer is $Mx=12$ and $My=25$)
 - a. Divide the higher frequency to get the same time quanta length as in the unit with the lowest oscillator frequency.
 - b. This makes it possible to have the same configuration of the CAN bit in all units, which removes any possible phase error.
4. If any combination of units do not comply with the equation, $osc_x/Mx == osc_y/My$, where Mx and My are integers, it causes an accumulating phase error.
 - a. If this is the case, there are very few configurations of the CAN bit that work and it could even be impossible for the higher bit-rates.
 - b. The above problem is reduced if small time quanta are used, allowing small bit adjustments to be made.
 - c. The phase error introduced by this condition is in addition to the oscillator tolerance error, making it hard to use low precision oscillators
 - d. This demands a carefully defined CAN bit to secure good protection of the sample point.

How to select CAN drivers

1. To minimize the effects from the CAN driver, select a CAN driver made for handling high bit-rates.
 - a. Note that high bit-rate typically results in higher EM emission, because the slew rate must be higher to form the small bits.
2. If EM-emission is a problem, use a CAN driver that support adjustable slew-rate and use as little slew-rate as possible. Also, use as low a bit-rate as possible.

How to select drop lines

A drop line connected to the main bus line is like an imperfection in the cable. The introduction of a drop line is like adding a circuit with capacitive and inductive loads to the ▷

CAN network, which affects the shape of the signal. The imperfection increases in proportion to the length of the drop line.

1. Use as short a drop-line as possible to avoid this problem.
2. High bit-rate signals with a high slew rate are more impacted than a signal with a lower slew rate, which can be used for the lower bit rate.
3. High frequency signals are more sensitive to imperfections.
4. The frequency where the drop-line causes a problem is related to the length of the drop-line.
 - a. $\text{freq} > 30/(\text{drop_line}[\text{meter}])$, is largely affected by the drop-line.
 - b. The digital signal has energy at the following frequencies; $\text{bit_rate} + 3*\text{bit_rate} + 5*\text{bit_rate} \dots$
 - I. For example 1 Mbit/s has energies at 1 MHz, 3 MHz, and 5 MHz.
 - II. At 1 Mbit/s, drop-lines over 3 m will be detectable.
 - III. At 1 Mbit/s, a total drop-length above 30 m will have a major impact.
 - IV. The problem is less acute if drop-lines are equally distributed along the main CAN network.
 - c. The distortion accumulates and increases with the number of drop-lines.

How to design the CAN cable

1. Use the same impedance in all cable segments.
 - a. Any change in the impedance along the cable causes signal reflections at the change of the impedance.
 - b. The twist is not directly necessary to secure the impedance. The impedance is defined by the cross-section of the wires in combination with the dielectric parameters of the wire isolation. The twist is a method to secure a continuous mechanical cross section.
 - c. Variations in impedance shorter than the wavelength have a minor impact.
 - I. For example 1 Mbit/s has energies at 1 MHz, 3 MHz, and 5 MHz.

Five parameters that affect CAN bit configuration

1. SJW, Synch Jump Width: This value defines how much of the CAN bit is reserved for handling accumulating phase-errors. If good oscillators are used in combination with common oscillator frequency in all units, this value is zero and can be ignored. The minimum value for the SJW parameter is 1 time quanta.
2. PHASE_SEGMENT2: This is the space between the sample point and the end of the CAN bit. This part must be large enough to fit the SJW plus the phase shift caused by non-accumulating phase errors (noise). If SJW is small it is possible to handle large variations from non-accumulating phase errors (noise).

3. PHASE_SEGMENT1: The phase shift, accumulating, and non-accumulating errors can come from both sides of the sample point. To cover this, phase segment 1 must be of the same size as phase segment 2.
4. PROPAGATION_SEGMENT: This part must be large enough to fit twice the longest delay in time between any unit connected to the CAN system.
5. SYNCH_SEGMENT: This part is the precision in the edge detection. The CAN status is sampled every time quanta and the bit-edge can be anywhere between two samples of the CAN network status. If the time quanta is short in time, it is possible to have a large number of TQ in a bit, making the synch_segment a relatively small portion of the bit.

Using data from installed nodes

By collecting data about the installed node, it is possible to calculate the values on those parameters. Those parameters are given by the CAN layout and the parameters in the ECUs. The minimum length of the CAN bit is defined by the sum of those parameters.

$\text{BIT_LENGTH_MIN} = \text{SYNCH_SEGMENT} + \text{PROPAGATION_SEGMENT} + \text{PHASE_SEGMENT1} + \text{PHASE_SEGMENT2}$.

In most cases, the used bit-length is longer than the BIT_LENGTH_MIN and in that case it is possible to divide this slack into the different parts in the CAN bit. To ensure the CAN system's robustness against variations in the cable length and delays in the circuits, this slack should be assigned to the PROPAGATION_SEGMENT. To ensure the CAN system's robustness against phase noise and variations in clock tolerance, this slack should be divided between PHASE_SEGMENT1 and PHASE_SEGMENT2. If it is not known which part is the weakest, the best solution is probably to divide the slack between PROPAGATION_SEGMENT, PHASE_SEGMENT1, and PHASE_SEGMENT2.

It should be noted that an unnecessary large SJW makes the CAN system more sensitive to noise, because the resynchronization mechanism can't know if the phase shift is due to accumulated phase shift, that should be compensated, or non-accumulated phase errors that could result in an unnecessarily large phase compensation.

With this approach you get the most robust CAN system according to the knowledge provided. The other approach is to predefine some basic setting for the bit-timing. If this setting is used, there is one system with maximum robustness. By deviating from this optimal system, a system becomes weaker compared to an optimal CAN system. CAN is very robust so it is possible to have larger deviations before the CAN system encounters any real problems. ◀



Author

Kent Lennartsson
Kvaser
info@kvaser.com
www.kvaser.com



The device type identification of multi-logical devices has been simplified and the EMCY protocol supports the logical device approach.

Logical devices are not new in CANopen technology. They have been introduced already in the beginning, in the mid of the 90ties. The idea is simple: The object dictionary address range for profiles standardized by CiA, 6000_h to 9FFF_h, is divided in eight parts of 800_h 16-bit indexes. For most of the CiA profiles this is sufficient, so that multiple profiles of the same kind or of different functionality can be implemented. For example, the CANopen device can host up to eight CiA 402 drive profiles meaning one CANopen interface is responsible for up to eight motion controllers. Another example is the combination of one CiA 401 (generic I/O) device and one dedicated CiA 420 profile for extruder downstream devices. This functionality is perhaps underestimated. Multiple logical devices can be used to hide sub-layered deeply embedded networks representing up to eight functions. This could also be used as migration path for proprietary sub-networks.

This feature is kept in CANopen FD (CiA 1301) and even better supported as in Classic CANopen (CiA 301). CiA 1301 specifies the device type parameter (Index 1000_h) as an array with up to eight sub-indexes 01_h to 08_h. They have the same structure as the 32-bit device type variable. The lower 16 bit contains the profile number and

the remaining 16 bit provide detailed information about the indicated profile functionality. The array approach is simple: reading the sub-index 00_h, the user knows the number of implemented logical devices. By USDO accesses, you can read the up to eight sub-indexes. After that you know the devices application functionality. In Classic CANopen, it is much more complicated to get this information.

EMCY protocol improvement

CANopen FD is based on the CAN FD data link layer featuring payloads of up to 64 byte. This allows enlarging the Classic CANopen EMCY protocol. The EMCY protocol specified in CiA 1301 provides 20 byte. It contains the same 8 byte as in Classic CANopen: the one-byte error register, the two-byte EMCY error code plus five byte for manufacturer- or profile-specific usage. The CANopen FD EMCY protocol contains additionally the logical device, which caused the production of this message. Further information includes the CiA profile number, the error status, and the time of the error occurrence. This time information is given in the TIME-OF-DAY data type as specified in CiA 1301. ▶

EMCY write producer

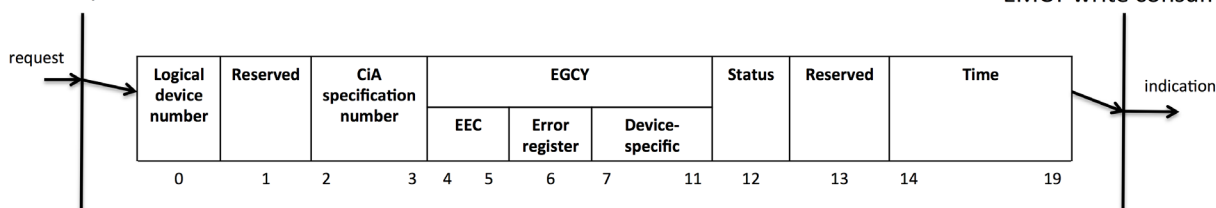

(Source: CAN in Automation)

With these improvements in the CANopen FD specification, the handling of multi-logical device implementations has been simplified and enhanced. The EMCY message can now report, which logical device has detected a problem. This is similar to the remote EMCY protocol as described in CiA 320-7, the CANopen-to-CANopen gateway specification. But it can also be used for other sub-layered network technologies.

Logical devices are also suitable for CiA application profiles. The CiA 417 profile for lift control systems can be used to describe up to eight lift applications at one single CANopen interface. The usage of multiple logical devices is still limited today, because device makers have overlooked it. Any device providing power consumption measurements can implement in one logical device its desired function (e.g. CiA 402 or CiA 408) and in a second logical device the CiA 458 energy measurement profile. With such devices the system designer can easily manage power consumption. Especially, aging of devices will be detected as early as possible, because they normally consume over time increasingly energy. This is nothing new, invented and specified already a couple of years ago. ◀

Author



Holger Zeltwanger
CAN Newsletter
pr@can-cia.org
www.can-newsletter.org

POSITAL

FRABA

DYNAMIC INCLINOMETER



Inclinometers with Dynamic Acceleration Compensation

Compensation of External Accelerations

Clean Angle Measurement During
Dynamic Movements

Optional Output of Acceleration and Rate of Rotation

IP69K Protected to Meet the Requirements
of Mobile Equipment

Accuracy 0.5° During Dynamic Movements

Available with CANopen Interface

POSITAL's Accessories

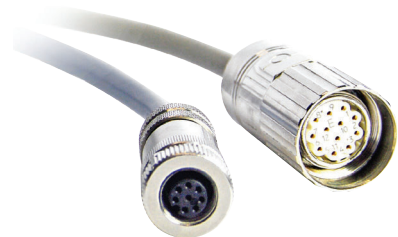

Rugged Connectors and Cables

www.posal.com

Connecting vehicles to the “clouds”

The possibility to monitor vehicles remotely by analyzing data gathered on the CAN networks opens new opportunities for every player along the value chain.

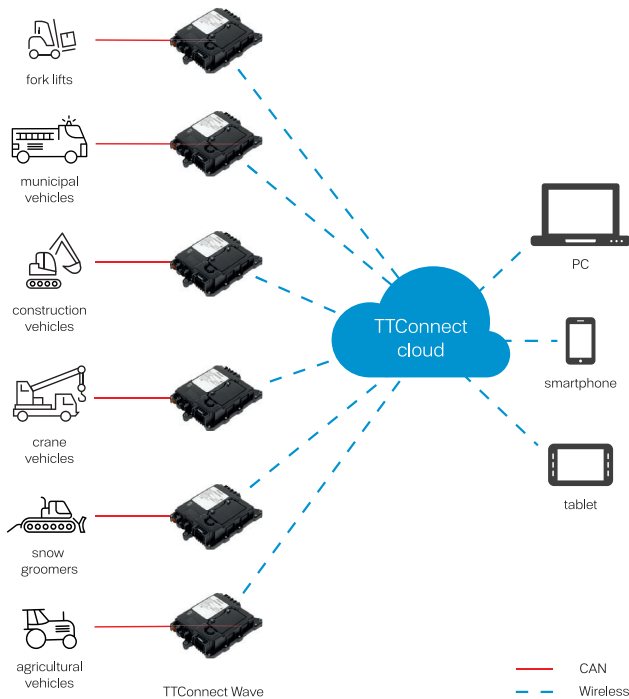

Figure 1: Customized dashboards and widgets for monitoring (Source: TTControl)

The Internet of Things (IoT) and the related mobile machinery telematics systems allow OEMs (original equipment manufacturer) and fleet owners as well as vehicle rental companies to utilize their machinery and equipment more efficiently. They gain a better understanding of how their vehicles are used by the operator and benefit from continuous system monitoring and diagnostics. Today, the availability of new technologies and the increase of requirements for safety, control, and efficiency demands for a new way of approaching the off-highway market.

OEMs as producers of vehicles need an efficient environment for local troubleshooting, diagnostics, and testing. By accessing the machinery remotely, they can reduce downtime and costs for local support engineers during the warranty period. Additionally, by using the machine’s CAN networks to access information contained within the device’s ECUs, OEMs can study usage patterns to anticipate operator needs that can be considered when developing new product generations.

For fleet owners it is key to reduce the total cost of ownership and improve their fleets. They also require efficient asset management through predictive maintenance, integration of recurring billing and subscription management for the end user management. The localization of vehicles is crucial in terms of security and anti-theft protection. Alarms, monitored through a web portal or sent automatically via email or SMS, ensure fast reaction to any kind of machinery issue.

At the forefront of this trend, TTControl developed a comprehensive IoT platform including a cloud solution and a gateway to address the needs of OEMs and fleet owners.

The TTConnect Cloud Service can be integrated seamlessly into existing electronic architectures of machinery, enabling remote access to all data available on the vehicle’s CAN networks. This includes traditional engine data such as engine rotation per minute, load or fuel consumption, but also additional diagnostic information gathered from electronic control units (ECU), hydraulic systems, and sensors. To achieve this, TTConnect Wave, a ruggedized IoT gateway suitable for harsh environments typical for off-highway vehicles, is installed on the machinery and connected to the CAN networks. The gateway collects data and redirects them to the “cloud”. This web portal is accessible anywhere, anytime, and from any web-enabled device, allowing the user to visualize and analyze all collected data. ▶

Joint-venture company

TTControl is a joint-venture company of TTTech and Hydac International offering control systems and operator interfaces for mobile machinery and off-highway vehicles such as fork lifts, cranes, municipal vehicles, snow groomers, as well as construction and agricultural equipment. As a provider for functional safety, the company unites two partners for the mobile machinery market. Its software and hardware platforms enable equipment manufacturers to develop reliable electronic control systems in a quick and economical manner.

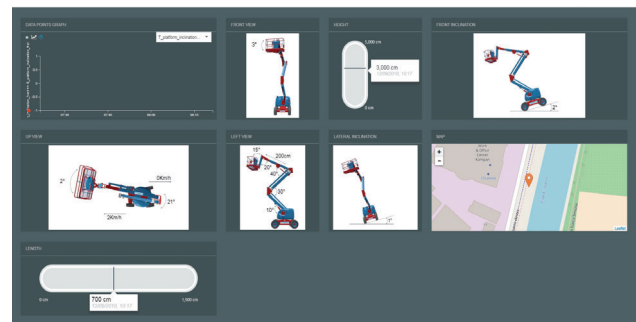

Figure 2: Processing machinery data from vehicle to cloud (Source: TTControl)

DIN 4630: Open network for body builders

The CAN-based open network specified in DIN 4630 (still under development) brings body applications such as truck-mounted cranes, refrigerators, etc. into the “clouds”. There are two options for the application layer provided: CANopen and J1939. The standard will define body application units (BAU), telematics unit (TMU), in-vehicle gateway unit (IGU), and fleet management unit (FMU). This German standard will be published in English language and is intended to be submitted for international standardization.

The “cloud” platform

The platform stores a database of the CAN data the user of the IoT solution wants to monitor. The configuration is transmitted to the IoT gateway device installed on the machine so only the selected parameters will be monitored. The “cloud” offers intuitive dashboards and widgets that can be customized, allowing for a fast understanding of any live parameters of the vehicle. User accounts with custom dedicated access rights can be created through the web portal in order to tailor the available data to the requirements of certain end user groups, e.g. for configuration engineers, service technicians or operators monitoring alarms.

The IoT gateway acts independently from the ECUs installed on the vehicle and therefore can be retrofitted easily. It reads data via multiple CAN networks and transmits it via its cellular interface when it is connected to a mobile network. When the vehicle is not connected, it stores the data until the vehicle re-enters an area with network coverage. The set of CAN data to read and transmit to the platform is defined by the CAN data database previously defined in the “cloud” configuration section.

The “cloud” offers customers an end-to-end solution allowing for a deep insight into vehicle data. The solution enables users to use CAN-based data efficiently for

predictive and preventive maintenance analyses, machine performance history, remote/local testing, diagnostics, and system calibration. The security core concepts of TTControl products are part of the solution allowing for custom access to data and warnings of any undesired events before they happen.

If desired, the “cloud” services can be customized with a dedicated web portal using branding colors and logos of the OEM or fleet owner. For each IoT gateway several dashboards can be created and widgets chosen from a wide selection in order to monitor only what is really needed in a clearly laid out graphical user interface. A map localization widget shows the position of the currently selected machine.

The solution is scalable and ready for deployment on hundreds or thousands of machineries with different properties thanks to the air gateway and ECU software upgrades that are configurable in the web portal by grouping devices with multiple criteria (i.e. machine type, machine model, geographical area, etc.) for scheduled machine upgrades.

The IoT gateway provides GSM/UMTS/HSPA+ connectivity, is currently licensed for 35 European countries and North America (USA and Canada), and can be installed on all off-highway vehicles with a CAN interface. The “cloud” service is accessible via internet browsers as available on PC, tablet, or smartphone featuring a secure multi-user login. No software programming skills are required to set up the system as it can be configured easily via graphical setup screens. ◀



Figure 3: Ruggedized IoT gateway (Source: TTControl)



Authors

Janosch Fauster, Andrea D'Achille
TTControl
office@ttcontrol.com
www.ttcontrol.com

Digital maintenance concepts

Predictive maintenance aims to eliminate faults and therefore machine breakdowns as quickly as possible. An even better approach is not to allow the faults to occur at all.



Figure 1: Condition monitoring is a preliminary stage to predictive maintenance (Source: HJS Emission Technology)

Mobile machines are investment goods used by many different parties: Manufacturers and owners, hire companies and operators, project managers and insurers. All of these have a common interest: to use the machines as efficiently as possible. One aspect of many for efficient use, albeit an extremely important and fundamental one, is to achieve as continuous and fault-free an operation as possible, because every standstill is associated with frequently enormous costs. However, without maintenance, faults and therefore machine breakdowns are certain to occur. Thus the object is to eliminate these faults as quickly as possible, and an even better approach is not to allow the faults to occur at all.

In case breakdowns occur due to defective parts on a machine and system, then the respective fault must be diagnosed. The appropriate spare parts must be available and brought rapidly to the location of installation. Accordingly, trained personnel should be able to reinstate operation of the machine within the shortest possible time. If repairs are not executed until a machine or system part has failed, then we speak of reactive or breakdown maintenance.

In almost all cases, maintenance plans are available which should ensure a high level of availability through regular servicing. If a car is not at least brought to a workshop for a regular oil change, then an increased risk of major engine damage is to be expected. Once this has occurred, then a simple oil change is no longer sufficient to repair the damage. Compliance with maintenance plans, which includes the preventative replacement of components prior to their failure or prior to the failure probability rising to an unacceptable

level, is called preventive maintenance. Within the scope of such maintenance work, lubricants are normally checked, supplemented or changed, partial or complete overhauls and adjustment work executed etc.

Through diverse use which cannot only be quantified through operating hours, kilometers, or cycle numbers, fixed, defined maintenance intervals can prove too long, and in other cases too short for an individual machine. Furthermore, no two machines or systems are absolutely identical in their construction or setup; therefore only the probability of a component or machine failure occurring can be predicted, but not a defect in an individual machine or component. This probability can be numerically calculated, simulated, determined in tests or estimated from experience with machines in the field.



Figure 2: TC3G – data-logger, gateway, network hub, edge controller – the all-in-one solution for predictive maintenance (Source: STW)

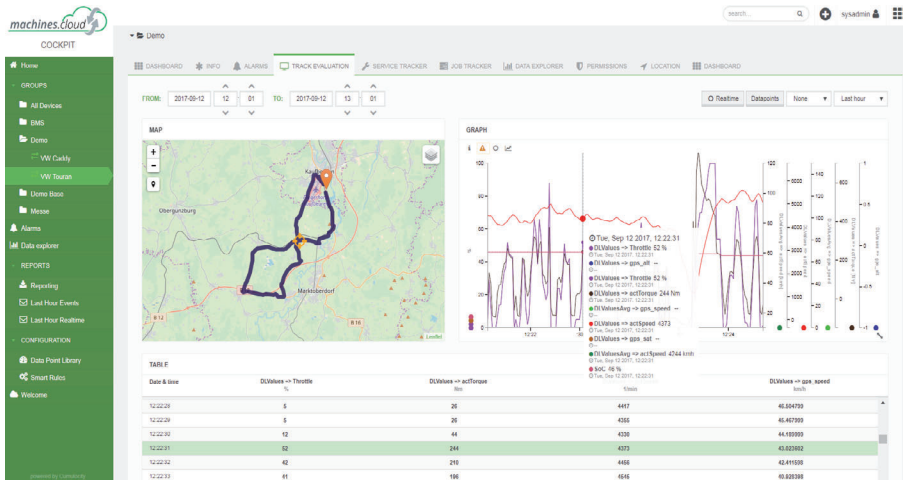

Figure 3: Data for condition monitoring is transferred onto the STW IoT platform machines.cloud (Source: STW)

Increasing digitalization and connectivity enables a gapless monitoring of machine parameters and therefore of the condition of the machine. Condition monitoring enables wear criteria to be derived from measurement values of an individual machine. As a result, the length of a drive chain can be continuously monitored, and on reaching a defined value, the delivery of a new chain is already initiated and an appropriate maintenance slot reserved for the execution of the replacement work. In this way, failures can be avoided in advance, i.e. preventatively. This is designated as predictive maintenance.

between information for the driving operation and for the work function, or, in case of an electrified machine, for the energy management.

In order to use the CAN data, an interconnection of the machine is required, and for this purpose the TC3G is equipped with wireless communication technologies. Internet-based services can be used via WiFi or mobile telecommunications. Establishing a VPN connection from the office to the machine on top of the IP link allows technicians to transparently access the CAN and therefore work directly with sensors and actuators from any office around the world. ▶

Automation experts



Automation made easy

Innovative solutions for all areas of industrial automation: Position sensors and object recognition, fluid sensors and diagnostic systems as well as identification, bus and control systems.

Tailor-made for industry-specific requirements, for example for hygienic applications in the food industry or for especially robust applications in the area of mobile machines. Thanks to IO-Link the sensors are well prepared for Industry 4.0.

We answer your automation questions. ifm – close to you!

ifm – close to you!



Go ifmonline
ifm.com



Membership

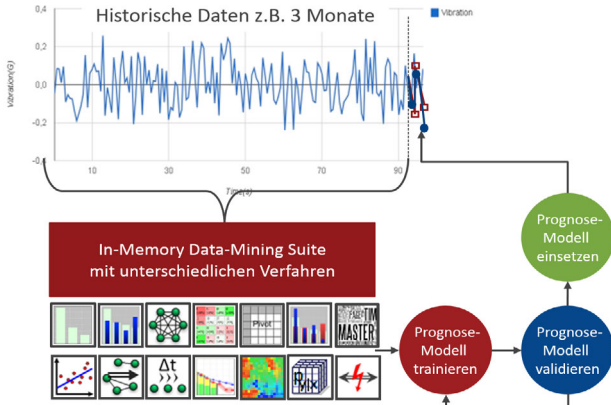

Figure 4: Data mining and forecasting procedures identify untypical conditions prior to occurrence of a failure (Source: Synop Systems)

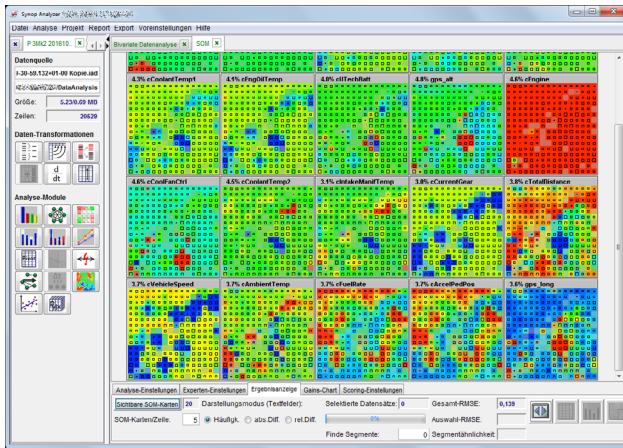

Figure 5: Neuronal networks are used in predictive maintenance (Source: Synop Systems)

Diagnose tools can be used as if one would be in front of the machine with a laptop.

The TC3G also allows to record CAN data. Using the IP link, the CAN data can be transferred to dedicated servers or cloud services. We differentiate between public, private, or hybrid solutions for cloud services. Sensor-Technik

Wiedemann (STW) provides their customers the use of the IoT (Internet-of-Things) platform machines.cloud, which has the advantage of openness regarding interfaces, scalability, and flexibility with respect to the hosting model. The open interfaces permit the transfer of CAN data to other servers or services. Here data evaluation, recognition of patterns, and also feedback that a fault is impending occurs.

These patterns can only be identified using methods of data analysis due to the large data volumes – Big Data – from many machines of one type. Mostly, a pattern can only be identified after one or several fault cases. For this purpose, the successive improvement of the algorithms occurs to further improve the failure predictions. To reduce the quantity of recorded and transferred CAN data through the data analysis, it is also possible to filter which parameters indicate a possible fault case. In the case of a mobile machine, this transfer often occurs via mobile telecommunications and, especially in case of roaming or large data volumes, can incur significant fees. Detection still takes place on a server and not on the machine. To enable this last step, corresponding algorithms are required on the machine which derive smaller but informative volumes of data, i.e. smart data, from the much larger volume of data already available.

Such a derivation of Smart Data would be expedient for vibration and modal analyses, if, for example, irregularities in operation can be deduced from a change in the vibration spectrum of a machine. The transfer of the high frequency-scanned time measurement values – in the frequency range – can take place directly on the machine. The calculated spectral pattern is compared with a specified nominal spectrum, and an alarm is triggered in case this is exceeded. The prerequisite for this is, of course, that the on-board unit is responsible for the recording of data and appropriate processing power is available in connection with the programmability. The TC3G with Linux as the operating system and a freely-available deployment package holds the best prerequisites for this job. Ultimately, a significant volume of data can be saved through the implementation of the algorithms.

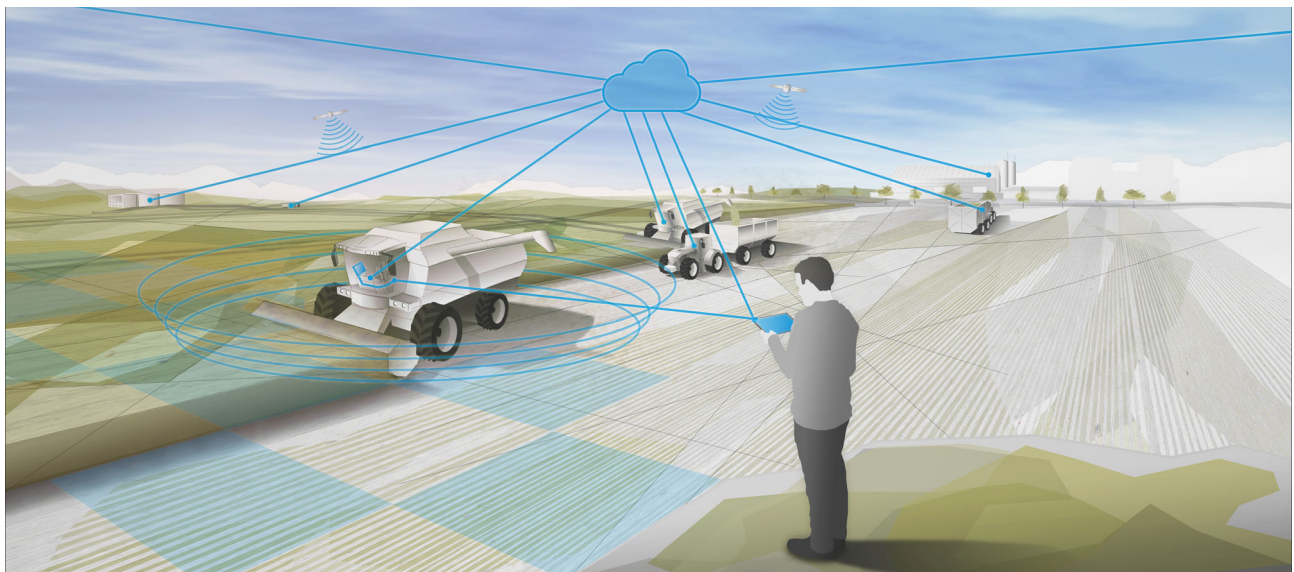

Figure 6: Networking enables access to important data and machine parameters at any time and any location (Source: STW)

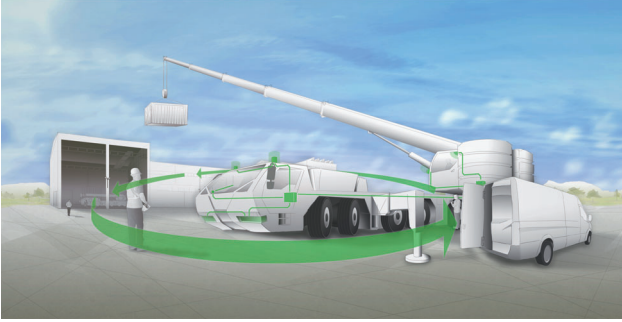

Figure 7: Work processes become more effective through automation (Source: STW)



Figure 8: Sustainable energy sources can contribute to their power supply through the electrification of vehicles (Source: STW)

It should not be forgotten that there are also further fields of interest and tasks in the environment of mobile machines. Depending on the point of view, information is required on the operation time for the purposes of invoicing, the transfer of orders and their processing for logistics, or simply path-tracking for monitoring occupational safety. With the transmission of basic data to machines.cloud, which can take place parallel to the calculation of Smart Data, ERP systems can for example be connected so that each interested party receives the data they require.

Author



Hans Wiedemann
 Sensor-Technik Wiedemann
presse@sensor-technik.de
www.stw-mm.de



YOUR LINK TO THE WORLD OF MODERN AUTOMATION - X90

www.br-automation.com/mobile-automation/

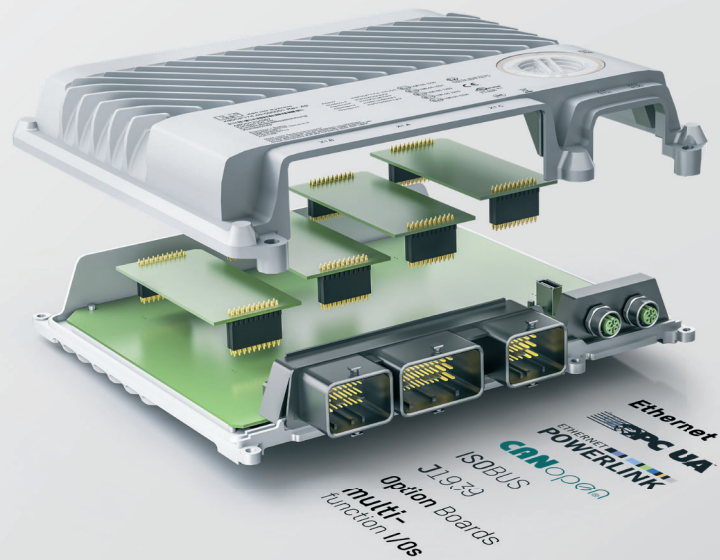

- Scalable hardware platform
- Preprogrammed software components
- 3-times faster development

PERFECTION IN AUTOMATION
 A MEMBER OF THE ABB GROUP



CANopen and the Internet-of-Things

The CANopen Internet-of-Things (IoT) specification is intended for embedded CANopen networks without IoT connectivity. It specifies to access local and remote CANopen networks using a CANopen IoT gateway supporting web protocols and communication services.



In many application fields, specifically-designed cell phone or tablet apps enable users to perform remote control and maintenance of air conditioning and heating at home or at the office. Those apps also allow to monitor condition of automated systems' components to know, when the components have to be replaced to prevent performance deterioration. This means there is a demand to provide an access from the web-based monitoring or control unit to the embedded sensor with serial industrial network interface and vice versa. This is fulfilled for the networks supporting internet protocols. This access may invoke cloud connection or rather use of the cloud for remote data processing or distribution. But what about embedded networks without embedded internet protocol controllers?

The CAN in Automation (CiA) Special Interest Group (SIG) CANopen IoT designed specification CiA 309-5. It allows CANopen embedded network users to access their local and remote CANopen networks using web protocols and communication services such as Restful HTTP, Websocket, and MQTT (coming soon).

Let us take a look on what is special about CANopen IoT (Internet-of-things). One of the challenging issues is that the end user has typically no detailed information on the serial industrial network interface. Usually, the serial industrial network system is totally transparent

for the end user. Nevertheless, serial industrial network systems often require geographical addresses such as device identifier, or device parameter addresses to allow an access to a specific network participant or a dedicated function. From anywhere in- and outside the embedded network, such a pool of harmonized-functions shall be accessible. Independent of the hardware platform and communication technique, the end user can rely on and control the harmonized functionality, without any knowledge on serial industrial network details. CiA suggested therefore using logical addressing as system-wide and technology-independent identifiers for CANopen elements. This addressing method allows functions such as data monitoring and process control, to be requested by users without knowledge of CANopen. Surely the system itself has to be pre-configured by the technician having CANopen know-how.

Furthermore, CiA members intend to offer more comfortable diagnostics by providing an enhanced, harmonized, visualization. The embedded devices provide their diagnostic data in a certain manner. This requirement may be solved by providing the entire visualization directly on the embedded device. Therefore any industrial terminal, tablet, cell phone, remote desktop, etc. might serve as human machine interface for diagnostic services. ▶

Visit us at
SPS/IPC/Drives 2018
hall 7A · stand 7A-302



Products for mobile automation



Maximum reliability for extreme conditions

If there is one thing we know after many years of experience with sensors and control systems:

Products used in mobile machines must be extremely robust. Exposed to heat, cold, moisture, dust and vibrations, they must guarantee maximum reliability – even if the going gets tough. This is why we offer corresponding solutions for operation, communication and remote maintenance. The result: increased uptime and maximum reliability of your machines. ifm – close to you!



Go ifm online
ifm.com/gb/mobile

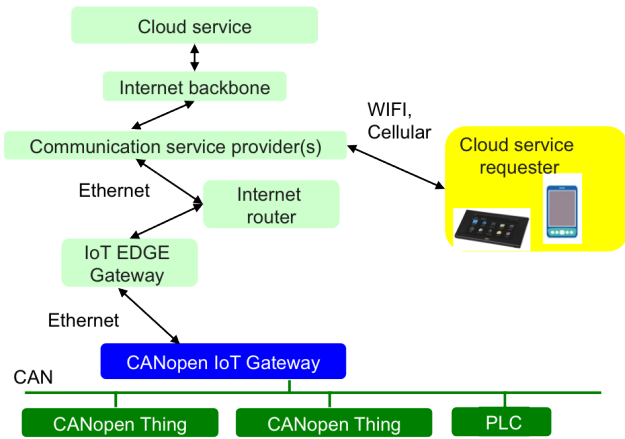

Figure 1: CANopen IoT cloud connection path example (Source: CAN in Automation)

By passing the limiting central host controller, this would open entirely new possibilities for (remote) diagnostic and maintenance. But providing its visualization is typically very memory demanding. Small sensors, which do not have the required memory resources, could provide their visualization using a gateway with HTTP and Websocket protocols with broadband Internet connection.

CiA members are currently working on this challenge for CANopen users. The SIG CANopen IoT provides a harmonized solution for the above mentioned challenges. On application level CiA intends to offer function-oriented services. Using these new services the application-specific, harmonized, functions can be initiated, monitored, and controlled. The functions are CANopen communication services and parameters mapped with logical addressing into Restful HTTP or Websocket. The functions are requested/collected either straight or through the cloud using an existing Internet infrastructure. The requester/collector is the web-based application while data provided is the application server located in the CANopen IoT gateway. For example the CANopen IoT gateway may either tunnel HTTP requests/responses straight to the web app or through the cloud. In case of the cloud, the communication path has to comprise the edge gateway having all tunneled data prepared for cloud-conform processing. The example of the local communication would include a CANopen IoT gateway, which contains the IoT and CANopen functional parts and manages the interaction between them. The CANopen functional part communicates with the CANopen

embedded network while the gateway provides the data obtained there to the other gateway functional parts. The IoT functional part prepares embedded CANopen data in JSON format and maps it into the Restful HTTP request/response accordingly for the transmission to the CANopen network/web-based application.

Since CANopen process data or diagnostic information may occur upon an event and thus data is dynamically updated for the submission to the web, the bidirectional communication may be optimized by use of a Websocket protocol. A Websocket session is established by the web app and once CANopen data occurs in the CANopen functional part, it is processed in the IoT part and is submitted to the web app. In this case, the web app does not need to poll HTTP requests for this data to the gateway. ◀

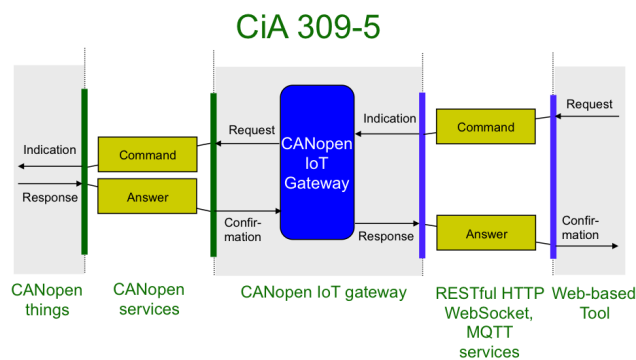

Figure 2: CANopen IoT gateway communication (Source: CAN in Automation)

Author

Oskar Kaplun
 CAN in Automation
headquarters@can-cia.org
www.can-cia.org



€140 Isolated CAN to USB

Introducing ValueCAN 4-1



- Exceptionally priced CAN to USB tool with no compromises
- 1 CAN channel, up to 1 Mb performance
- Pass-through support via J2534 / RP1210 / DLL
- Standalone mode
- Fully isolated
- IP65 rated
- Aluminum case
- Small size, easy to keep with your laptop
- CAN FD and multi-channel versions also available

Find out more: www.intrepidcs.com/vcan4

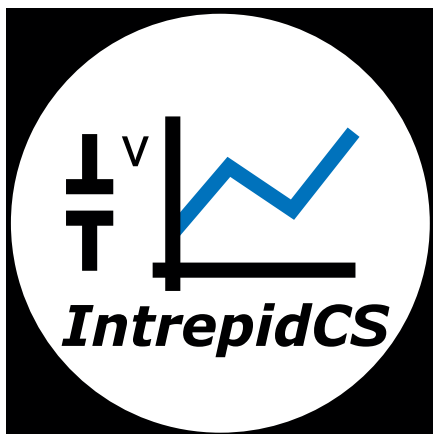

INTREPID

CONTROL SYSTEMS GMBH

www.intrepidcs.com

+49 (0)721 1803083 -1

icsgermany@intrepidcs.com

USA Germany UK Japan Korea China India Australia

Wireless CAN without WLAN or Bluetooth

In two developed concepts, dual-mode radio enables CAN participants to be integrated wirelessly into a CAN network. Constructed from a few components, a protocol-free, real-time transmission and thus transparent integration into CAN is provided.

Embedded control units and sensors generally communicate in modern electronic and mechatronic systems via serial bus systems such as CAN or LIN. Communication is usually wired, so that the cable harness for communication can become very large [1]. It is therefore obvious to save cables and associated plugs, e.g. for non-safety-critical comfort systems, and to replace them with directional radio links for short distances. However, existing radio systems such as WLAN or Bluetooth do not meet the requirements of the applications in terms of real-time capability and robustness. They are also expensive compared to conventional cabling. The alternative presented in this article can be constructed from a few components and enables protocol-free, real-time transmission, and thus transparent integration into a serial bus system such as CAN.

The CAN system is widely used in automotive and industrial applications to establish local networks and enable communication between control units [2]. The network participants, such as control devices or sensors, are connected to the common bus lines via short stubs. The transmission medium usually consists of a twisted two-wire line (CAN-H, CAN-L) via which the signals are transmitted differentially at up to 1 Mbit/s (or up to 8 Mbit/s for CAN FD). A micro-controller is connected to the lines via a CAN transceiver, which converts the digital signals of the micro-controller into the differential signals and vice versa. Although this would be desirable and advantageous in numerous applications, wireless CAN transmission according to the CAN standard is currently not planned.

Current options for wireless CAN transmission rely on protocol-based radio standards such as WLAN or Bluetooth. Thus the CAN data in the transmitter must be converted to the wireless protocol and reset in the receiver. Transparent and real-time transmission in the sense of the CAN network is not possible in this way. The radio connection thus functions as a gateway between two CAN networks.

CAN in dual-mode radio

The wireless CAN described below is based on dual-mode radio. Two free space modes are used for data transmission and the receiver evaluates the differences between the parallel phase modulated signals. With the dual-mode radio (Figure 1), all basic modulation types can be implemented and combined with each other [4]. However, the concept was limited to the modulation of a data signal using phase modulation.

The advantage of the dual-mode system is that it requires only a few components compared to classic radio systems. The transmitter uses only one oscillator. Since the oscillator does not have to meet high requirements in terms of phase noise or frequency stability, it can be selected cost-efficiently. Furthermore, the phase shifters and the 3-dB signal splitter can be set up discretely or by means of cables, depending on the frequency. The critical components of the system are the switches, since the maximum possible data rate depends on them. The receiver also consists only of a mixer and possibly amplifiers.

A disadvantage of the system is that the antennas must be aligned at $\pm 30^\circ$, so the dual-mode system is not able to provide omnidirectional radiation. Depending on frequency and type, the antennas require the most space compared to the rest of the system.

Two concepts for wireless CAN

The easiest way to integrate a dual-mode radio link into a CAN network is to pick up the differential CAN signals and feed them directly to the dual-mode modulator. The problem on the receiver side is that the received unbalanced signals have to be converted back into a CAN-compliant differential signal. This approach was not followed in the concept because the effort for generating the CAN signals \triangleright

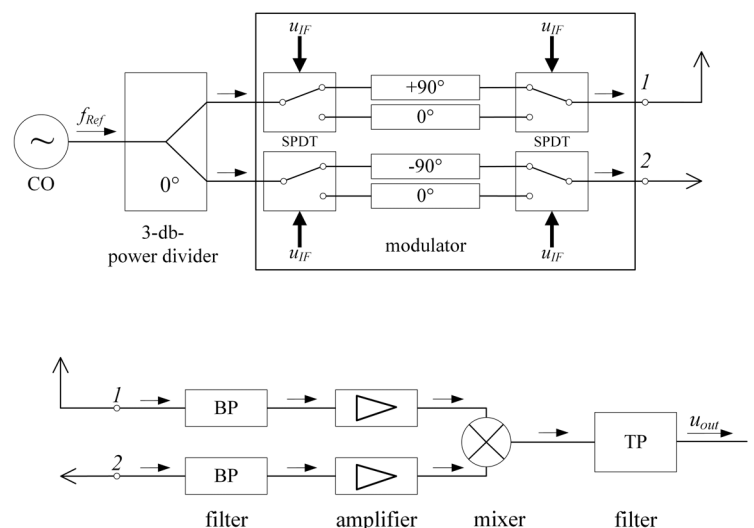

Figure 1: Principle structure of a dual-mode radio system with transmitter (top) and receiver (bottom) (Source: FH Aachen)

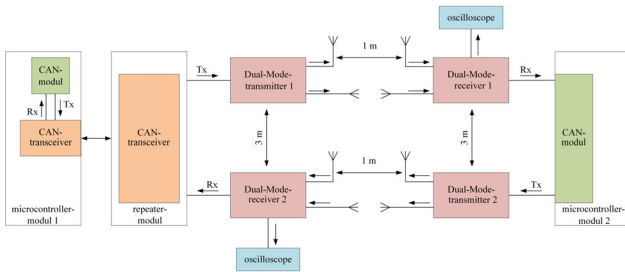

Figure 2: Wireless connection of a CAN node realized by separating the Rx/Tx signals (micro-controller with CAN module, right) via dual-mode radio to a CAN network (Source: FH Aachen)

is too great. Instead, two concepts based on CAN transceivers and a repeater circuit were developed, implemented, and tested.

In the wired connection of a CAN node, communication between transceiver and micro-controller takes place via two standardized signals, Rx (receive data), and Tx (transmit data). In the first concept for wireless integration of the CAN node (Figure 2), the connection between transceiver and micro-controller was cut, so that the transceiver still converts the differential CAN signals to the Rx/Tx signals on the network side. Between transceiver and micro-controller lies the dual-mode radio link, which is formed by a transmitter/receiver pair for each direction. The transceiver evaluates differential signals that are to be transmitted from the network to the micro-controller and transmits them as Tx signals to the dual-mode transmitter. The conversion to the radio link takes place in the

dual-mode transmitter. The received signals are evaluated and sent as an Rx bit stream directly to the CAN module of the micro-controller. The other direction of the data transfer works in the same way. The transmission delays caused by the radio system are very low that the CAN timing with regard to arbitration or acknowledgement generation is adhered to and it is not apparent to the CAN network that the CAN node is integrated via a radio link. Since only the dual-mode connection is required as hardware, this concept is very cost-effective.

In the second concept, the micro-controller is replaced by a CAN repeater circuit (Figure 3) [3]. The CAN repeater circuit can be used, for example, to expand an existing CAN network. This makes it possible to set up a CAN radio gateway between two CAN networks without using a micro-controller. Alternatively, you can simply connect two CAN nodes in a galvanically-isolated point-to-point connection. This solution is also very cost-effective due to the small number of components required.

In order to determine the quality of the radio transmission and the maximum data rate of the discrete dual-mode radio system, a bit error rate measurement (BER) was first performed (Figure 4) and eye diagrams recorded (Figure 5) - at a clock frequency of 1 MHz, the maximum data rate of high-speed CAN. Not a single transmission error occurred during the 30-minute measurement, resulting in a statistical bit error rate of 10^{-9} . The wide open eye of the diagram confirms the good signal characteristics as well as the resistance of ▶

LIN&CAN Tools for test and production

Configure - Connect - Operate
We support you all the way!
 + 49 6151 93591-0

SINCE
1986
ISO 9001 : 2008

www.lipowsky.com info@lipowsky.de

LIPOWSKY
INDUSTRIE-ELEKTRONIK

Distribution China: Hongke Technology Co., Ltd
 Distribution USA: FEV North America Inc.

Ph: +86 400 999 3848
 Ph: +1 248 293 1300

sales@hkaco.com
marketing_fev@fev.com

www.hkaco.com
www.fev.com

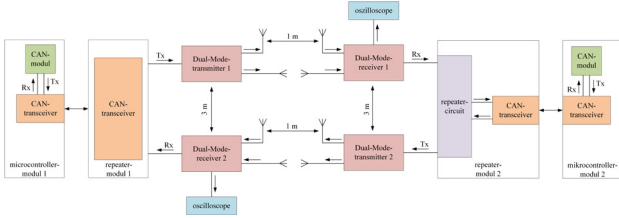

Figure 3: Use of dual-mode radio as gateway via CAN repeater (Source: FH Aachen)

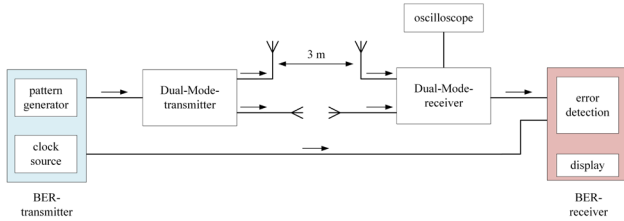

Figure 4: Block diagram for setting up the bit error rate measurement (Source: FH Aachen)

the radio system to interference pulses, noise, and jitter. A closing of the eye could only be determined at a data rate of 8 Mbit/s. Thus a transmission of CAN FD data is also provided.

Both concepts were implemented and tested after the functional verification for the 4,5-GHz dual-mode radio link. The two network participants were each approx. 1 m away from each other. For the tests, a micro-controller module sends CAN messages with an identifier x55 and defined user data. The correct reception of the data was checked using the other micro-controller module and the corresponding oscilloscope. The acknowledgement of the received data by sending the ACK bit of the CAN transmission was also checked. In both cases, perfect CAN communication up to a bit rate of 1 Mbit/s via the dual-mode radio link could be demonstrated. There were no CAN errors during the tests.

Conclusion

The wireless CAN described here is based on dual-mode radio and enables CAN participants to be integrated wirelessly into a CAN network. Both presented and developed concepts function correctly and enable the construction of wireless CAN interfaces. For the CAN nodes involved, it is irrelevant whether the data transmission is wired or via the radio link. With this concept, the cable can be replaced 1:1 and the other advantages listed above can be realized. Due to the simple design with only a few

components, a transfer of the discrete design into a simple and small IC for use in embedded systems is possible and in planning. The development of suitable ICs up to component size would enable even better integration into embedded systems.

The dual-mode system works independently of the antennas used, so that an optimized antenna geometry can be used for embedded applications with the IC. The antennas used in this study do not yet provide optimal characteristics. The use of directional antennas, such as patch arrays or printed Yagi antennas, would be advantageous as it reduces crosstalk between two dual-mode systems and allows the transmitter and receiver to be integrated into one housing.

Compared to classic radio systems, dual-mode radio offers two security aspects. Since dual-mode radio uses two antennas with different polarizations, a potential attacker must insert two receiving antennas with exactly the same polarization into the radio path in order to be able to monitor the signal. Furthermore, by using a voltage-controlled oscillator, it is possible to make the baseband signal noisy and distribute the high-frequency energy over a wider frequency range. This ensures that the dual-mode signal almost disappears in the noise. Demodulation of the signal by the receiver is still possible, but finding the dual-mode signal is more difficult for an attacker without a more-detailed knowledge of the system.

References

- [1] Grell, D., „Rad am Draht: Innovationslawine in der Autotechnik“, c't magazin, 2014
- [2] Lawrenz, W., Obermoeller, N. (publisher), „CAN: Controller Area Network: Grundlagen, Design, Anwendung, Testtechnik“, VDE VERLAG GmbH, Berlin, 5. Auflage, 2011
- [3] Thomas Mauer, Texas Instruments (publisher): TIDA-01487 Isolated CAN FD Repeater Reference Design, <http://www.ti.com/lit/ug/tidudb5/tidudb5.pdf> (last access 12/2017)
- [4] Heuermann, H., „Hochfrequenztechnik: Komponenten für High-Speed- und Hochfrequenz-schaltungen“, Vieweg+Teubner, Wiesbaden, 2. Auflage, 2005

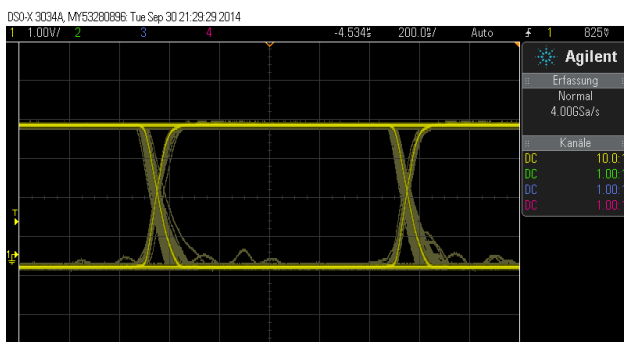
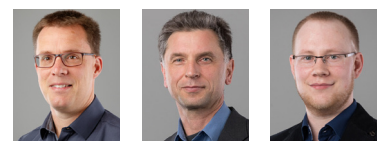

Figure 5: Eye diagram at 1 MHz (Source: FH Aachen)



Authors

Felix Huening, Holger Heuermann, Franz-Josef Wache
 FH Aachen
info@fh-aachen.de
www.fh-aachen.de

CAN Newsletter Online: Wireless CAN



Machine-to-machine **Wireless CAN bridge**

The CAN-Sync wireless CAN bridge from Humanistic Robotics (HRI) allows the user to transmit CAN data wirelessly over a transparent point-to-point bridge, without modifying the data. J1939 and CANopen are supported.

[Read on](#)



WLAN gateway **Wireless CAN data transmission**

With the CANbox by Caemax (Germany), measurement data can be sent or received from one or two CAN interfaces. The data can be buffered and forwarded via WLAN, e.g. to the WLAN client on the user's notebook.

[Read on](#)



Wireless CAN interface **For off-highway vehicles**

Mico Incorporated (USA) introduced its Mobeus Electrohydraulic wireless CAN interface for Mobeus Electrohydraulic braking systems. It is compatible with J1939.

[Read on](#)



Wifi bridge **Wireless CANopen and J1939 access**

The Wi-Fi CAN Bridge (WCB) by Electrum Automation (Sweden) enables wireless CAN access over Wi-Fi 802.11b/g. It enables monitoring the CAN network directly from a smartphone and supports CAN, CANopen, and J1939 protocols.

[Read on](#)



Android app **Mobile diagnostics from a single source**

RM Michaelides (Germany) has developed a combination of their Dashboard visualization software with the wireless CAN interface CANlink WLAN. The combination provides error diagnosis from a single source.

[Read on](#)



GSM/UMTS unit **Remote diagnostics reduce travelling**

Proemion (Germany) has presented the CANlink mobile, which lets users diagnose a vehicle or machine from a remote location without being there. It features CAN connectivity.

[Read on](#)



Isolation unit **Hazardous environments**

With the CBI-100 CAN isolator from Cervis (USA), the isolation of CAN data from hazardous environments is enabled. The product is specified for the use with the company's GWM sensor/data acquisition modules.

[Read on](#)

CANgine Light

CANgineLight is a small and flexible CAN converter. It provides a platform independent access to any CAN network due to its classic serial RS232 interface.



Currently available with 3 different firmware versions:

- **CANgineLight Generic:**
a simple CAN converter that converts the CAN messages into an ASCII stream and vice versa.
- **CANgineLight FMS:**
offers access to real-time telematics data in commercial vehicles via the FMS interface.
- **CANgineLight CANopenIA:**
offers an easy, direct access to CANopen networks.

Based on the CANgineLight, customer-specific firmware variants and even hardware variants are also possible.

Features:

- CAN FMS protocols: FMS1, 2, 3 Bus & Truck
- CAN baudrate up to 1 Mbit/s
- RS232 baudrate up to 230400 bit/s
- Power supply: 7 – 30 V

Benefit from more than 15 years of CAN experience.

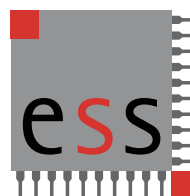

ESS Embedded Systems Solutions GmbH

Industriestrasse 15
76829 Landau in der Pfalz
Phone: +49 6341 3487-0
Email: sales@cangine.com
www.cangine.com
www.essolutions.de



CAN in Automation

The non-profit CiA organization promotes CAN and CAN FD, develops CAN FD recommendations and CANopen specifications, and supports other CAN-based higher-layer protocols.

Join the community!

- ▶ Initiate and influence CiA specifications
- ▶ Receive information on new CAN technology and market trends
- ▶ Have access to all CiA technical documents also in work draft status
- ▶ Participate in joint marketing activities
- ▶ Exchange knowledge and experience with other CiA members
- ▶ Get the CANopen vendor-ID free-of-charge
- ▶ Get credits on CANopen product certifications
- ▶ Get credits on CiA training and education events
- ▶ Benefit from social networking with other CiA members
- ▶ Get credits on advertisements in CiA publications

*For more details please contact CiA office
at headquarters@can-cia.org*

www.can-cia.org