

December 2020

CAN Newsletter

Hardware + Software + Tools + Engineering

3rd generation of the CAN data link layer

The physical layer in the CAN XL world

Change in automotive communication systems

IP concepts with CAN XL

www.can-newsletter.org

CAN XL

Six-Channel CAN FD Router and Data Logger

■ PCAN-Router Pro FD

The PCAN-Router Pro FD links the data traffic of up to six modern CAN FD and classic CAN buses. This allows the conversion from CAN to CAN FD or vice versa and therefore, the integration of new CAN FD applications into existing CAN 2.0 networks. In addition, the CAN messages can be recorded on the internal memory or on an inserted SD card.

The PCAN-Router Pro FD can be programmed freely for specific applications. The firmware is created using the included development package with GNU compiler for C and C++ and is then transferred to the module via CAN. Various programming examples, facilitate the implementation of own solutions. On delivery, the PCAN-Router Pro FD is equipped with a firmware for the configurable recording of CAN and CAN FD data traffic.

Specifications:

- STM32F765NIH6 microcontroller (based on Arm Cortex M7)
- 32 MByte SDRAM in addition to microcontroller RAM
- 6 High-speed CAN channels (ISO 11898-2)
 - Comply with CAN specifications 2.0 A/B and FD
 - CAN bit rates from 40 kbit/s up to 1 Mbit/s
 - CAN FD bit rates from 40 kbit/s up to 12 Mbit/s
 - NXP TJA1043 CAN transceiver with wake-up

- Alternative pluggable transceiver modules on request
- CAN termination switchable, separately for each channel
- CAN connections are D-Sub, 9-pin
- I/O functionality
 - 4 digital I/Os, usable as digital input or output (2 with High-side and 2 with Low-side switch)
 - 1 analog input (0 - 33 V)
- Recording of CAN data and error frames
 - Internal memory: 16 GByte pSLC eMMC
 - SD card slot for additional memory
 - USB connection for accessing the data memory (e.g. recorded log data)
- Conversion of logging data to various output formats using a Windows software
- Wake-up function using separate input, CAN bus, or real-time clock
- Power supply 8 - 32 V with protection against overvoltage and reverse polarity
- Slot for a backup battery for defined switch-off behavior (e.g. for log data saving)
- Extended operating temperature range from -40 to 85 °C (-40 to 185 °F)
- Aluminum casing with flange



www.peak-system.com
 Take a look at our website for the international sales partners. Scan the QR code on the left to open that page.

PEAK-System Technik GmbH
 Otto-Roehm-Str. 69, 64293 Darmstadt, Germany
 Phone: +49 6151 8173-20 - Fax: +49 6151 8173-29
 E-mail: info@peak-system.com





CAN XL

3 rd generation of the CAN data link layer	4
The physical layer in the CAN XL world	8
Change in automotive communication systems	28
IP concepts with CAN XL	32

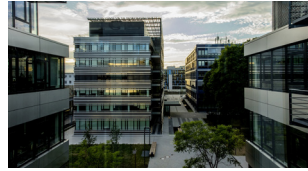

Business

CiA's 700 th member: Rohde & Schwarz	16
---	----

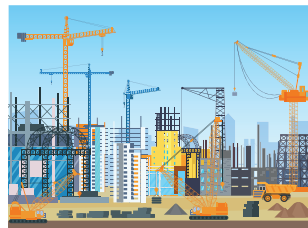

CANopen

Industrial battery chargers support CANopen	18
Injector and scanner communication	20
CANopen devices in J1939 networks	24
Diagnostic solutions for mobile machines	26



System design

Data is the new oil	35
---------------------	----



Imprint

Publisher

CAN in Automation GmbH
Kontumazgarten 3
DE-90429 Nuremberg

publications@can-cia.org

www.can-cia.org

Tel.: +49-911-928819-0

Fax: +49-911-928819-79

CEO

Reiner Zitzmann

AG Nürnberg 24338

Downloads September issue:

(retrieved November 25, 2020)

2905 full magazine

Editors

Olga Fischer (of)

Cindy Weissmueller (cw)

Holger Zeltwanger (hz)

(responsible according

to the press law)

pr@can-cia.org

Layout

Nickel Plankermann

Media consultant

Meng Xie-Buchert

(responsible according

to the press law)

Distribution manager

Rosanna Rybin

© Copyright

CAN in Automation GmbH

CAN FD or CAN XL?

CAN FD and CAN XL are not in competition. They address different use-cases. CAN FD is designed for embedded real-time control systems providing more bandwidth than Classical CAN and a larger payload (up to 64 byte). Using CAN SIC transceivers as specified in CiA 601-4 allows data-phase bit-rates of up to 8 Mbit/s depending on the physical layer design (e.g. topology, cable, and connector impedance).

CAN XL features large payloads (2 048 byte in maximum). It provides features to be used for higher-layer protocols similar to Ethernet. In opposite to 10-Mbit/s Ethernet, CAN XL is more reliable and robust as well as more cost-effective. CAN XL is suitable for backbone applications in complex network architectures. The maximum data-phase bit-rate is 10 Mbit/s and perhaps a little bit more. One of the key advantages of CAN XL is its scalability. In this issue of the CAN Newsletter magazine you will find a few articles explaining CAN XL in more detail.

Users shouldn't wait for CAN XL, if their application is real-time control. Of course, they can use CAN XL also for such control purposes, but the bandwidth increase is not that high compared to CAN FD. Standardized higher-layer protocols based on CAN FD are already available (CANopen FD as specified in CiA 1301) or will be released soon (SAE J1939-22).

3rd generation of the CAN data link layer

Since a couple of years, the automotive industry substitutes Classical CAN by means of CAN FD, which is internationally standardized in ISO 11898-1:2015. In parallel, the CAN community develops the next generation of the CAN data link layer protocol: CAN XL.

Priority ID	RMF	IDE	FDF	XLF	BRS	ESI	SDT	SEC	DLC	VCID	AF	LLC data
11 + 18 bit	1 bit	1 bit	1 bit	1 bit	1 bit	1 bit	8 bit	1 bit	11 bit	8 bit	32 bit	0 to 2048 byte

Legend

RMF: remote frame

IDE: identifier extension

FDF: flexible data rate field

XLF: extra large field

BRS: bit-rate switch

ESI: error state indicator

SDT: service data unit type

SEC: DLL security indication

DLC: data length code

VCID: virtual CAN network ID

AF: acceptance field

LLC data: logical link layer data

Figure 1: LLC frame fields - support for all three CAN protocol generations (Source: CiA)

Since December 2018, the CAN in Automation (CiA) special interest group (SIG) CAN XL is specifying the CAN XL protocol features. In the meantime, the SIG CAN XL has additionally established three task forces (TF): the TF CAN XL physical layer, the TF CAN XL higher layer, and the TF CAN XL security. Relevant topics are discussed in the respective TFs (task forces). The CiA 610 document series and the CiA 611 document series will include the CAN XL relevant specifications.

The SIC CAN XL develops directly the specification of the CAN XL data link layer, which will be released as CiA 610-1 document: CAN XL specification and test plans – Part 1: Data link layer and physical signaling. After two-years intensive discussion, the CAN XL data link layer protocol specification is recently technically stable and will be released in beginning of 2021 as CiA document. As the next step, the ISO standardization will be started.

This article introduces briefly the CAN XL data link layer protocol, namely to answer the question, what is CAN XL. Have in mind that the CiA 610-1 document is still under development. Therefore, the final CiA 601-1 document could have differences compared to the content in this article – even if the probability is very low.

The CAN XL data link layer protocol has the following key features:

- ◆ Large data field with up to 2 048 byte
- ◆ Higher-layer management information
- ◆ Improved reliability by means of two CRC fields

OSI data link layer protocol data unit (PDU)

SOF	Arbitration	Control	Data (field)	CRC	ACK	EOF
1	15 bit	81 bit	1 to 2048 byte	36 bit	6 bit	7 bit

Figure 2: CAN XL MAC frame fields (Source: CiA)

LLC and MAC sub-layers

Similar to Ethernet, the CAN standard (ISO 11898 series) specifies two data link sub-layers:

- ◆ Logical link control (LLC): It acts as a sub-layer between the OSI network layer and the media access control (MAC) sub-layer.
- ◆ Media access control (MAC): It is responsible for moving frames from the LLC sub-layer to the PMA (physical media attachment) sub-layer and protects the transmission by means of stuff-bits, CRC fields, etc.

The LLC frame structure shall contain all content needed for all CAN frame formats and types, including the selection of a specific CAN frame format. In the interaction between LLC and MAC, the content of that parts of the LLC frame that are not used for the selected CAN frame format shall be ignored. Figure 1 shows the LLC frame format specified in CiA 610-1. The LLC frame supports all three CAN protocol generations: Classical CAN, CAN FD, and CAN XL. The fields of the LLC frame that are used by CAN XL are highlighted green.

Priority and addressing

In Classical CAN and CAN FD, the CAN-ID field (11 bit or 29 bit) is used for both arbitration and addressing purposes. In CAN XL these functions are separated. The CAN XL protocol separates the priority functions (11-bit ID) and the addressing (32-bit acceptance field). ▶

Priority ID	RRS	IDE	FDF	XLF
11 bit	1 bit	1 bit	1 bit	1 bit

Figure 3: XLFF: arbitration field (Source: CiA)

- ◆ 11-bit priority ID sub-field: This field provides the uniquely assigned priority of the CAN XL data frame.
- ◆ 32-bit acceptance field: This field can contain node address or content indication information like a message ID.

Service data unit type (SDT)

The SDT is a feature that is usable for higher-layer protocols. The 8-bit SDT indicates the used next OSI layer protocol. It is an embedded (OSI) layer management information as described in ISO 7498-4:1998 and is similar to the Ethertype field in the Ethernet frame.

CiA 611-1 specifies the SDT values and the corresponding usage to unfold the power of this field. The first version of CiA 611-1, that is planned to be released in the next months, will specify SDT values for:

- ◆ Content-based addressing (i.e. use of message IDs)
- ◆ Node addressing
- ◆ Nodes tunneling of Ethernet frames
- ◆ Classical CAN and CAN FD data frames

Virtual CAN network ID (VCID)

The 8-bit VCID field allows running up to 256 logical networks on one single CAN XL physical network segment. This will allow to use many protocols in parallel, on the same physical CAN network. This field is also an embedded (OSI) layer management information as described in ISO 7498-4:1998.

Optional DLL security

The CAN XL TF security would specify the CADsec data link layer security protocol. The SEC bit in the control field indicates, if this CAN XL data frame uses the CADsec protocol. The CADsec protocol features a header with cipher control information, the CAN secure channel ID, and a freshness value. The 16-byte trailer contains the authentication tag.

MAC frame in XL format

The MAC sub-layer comprises the functions and rules related to encapsulation/de-capsulation of the transmitted/received data, error detection as well as signaling, and management of the medium access.

There is just one single CAN XL MAC frame format, called CAN XL frame format XLFF. The frame has a variable length and can hold 1 byte to 2 048 byte in the data field, while the data length can change in one-byte steps. ▶

CAN Controller IP Core

HIGHLY-FEATURED

- Ultra-low latency capable
- Minimal software overhead
- Optimized for AUTOSAR & SAE

RELIABLE

- Robustly verified
- Plugfest tested
- Certified by independent testing houses in US & Europe

FLEXIBLE

Single Controller for
CAN 2.0, CAN FD,
TTCAN & CAN-XL

SAFE

ISO-26262 ASIL-B
and ASIL-C Ready
Versions

PROVEN

in hundreds of
automotive,
industrial and
aerospace prod-
ucts since 2006

PORTABLE

- Can be implemented on any FPGA or ASIC technology
- Works with any Transceiver
- Bear metal, RTOS, & Linux drivers

CAST

resXL	ADS (ADH, DH1, DH2, DL1)	SDT	SEC	DLC	SBC	PCRC	VCID	AF
1 bit	4 bit	8 bit	1 bit	11 bit	3 bit	13 bit	8 bit	32 bit

Legend

ADS: arbitration-to-data phase switch;

PCRC: preface CRC (cyclic redundancy check);

SBC: stuff-bit counter

Figure 4: XLFF: control field (Source: CiA)

On transmission, an LLC frame is converted into a MAC frame. On reception, a MAC frame is converted into an LLC frame. MAC frames in XL format are composed of seven different bit fields as shown in figure 2. In figure 2, 3, 4, and 5 the fields marked in green are automatically added by the MAC sub-layer, and the grey fields are provided by the LLC frame.

ADS field in control field and DAS field in ACK field

For higher bit-rates (10 Mbit/s and above) the new CAN SIC XL transceivers specified in CiA 610-3 are suitable. The CAN SIC XL transceivers have three modes to achieve the “fast bits” in the data phase but also allow arbitration in the same frame. The modes are named SIC mode, Fast TX mode, and Fast RX mode. In the SIC mode, the transceiver drives dominant and recessive bits, as known from Classical CAN. In the Fast TX mode, the transceiver drives level-1 and level-0 signals with differential voltage levels of -1 V and +1 V. In Fast RX mode the transceiver does not drive the network. Additionally, CAN SIC XL transceivers support the medium-independent CAN interface (MICI), that is required to signal the mode switching.

The first bit in the ADS field is the ADH bit. It is sent as logical 1. During this bit, the CAN SIC XL transceiver is switched from SIC mode in Fast TX or Fast RX mode. The MICI interface sends PWM symbols of arbitrary value to perform the proper transceiver mode switch. All CAN XL nodes ignore the sampled value of the ADH bit. The first bit in the DAS field is DAH bit. It is sent as logical 1. This is the bit, where the transceiver mode in the CAN XL SIC transceiver is switched back to SIC mode.

The CAN XL data frame includes two CRC (cyclic redundancy check) fields: the 13-bit Preamble CRC (PCRC) and the 32-bit frame CRC (FCRC). The CRCs are cascaded, which means FCRC protects the whole frame, including the PCRC. Both CRCs are able to detect any five randomly distributed bit-errors. This corresponds to a Hamming distance of 6. The university of Stuttgart proposed the CRC polynomials for PCRC and FCRC, and they published their argumentation in iCC (international CAN conference) 2020 proceedings. At the moment, the University of Kassel

is evaluating the error detection capabilities of the CAN XL MAC layer, what also means that the CRC polynomials are double-checked. The research report by the Kassel University is expected by end of 2020.

CAN XL and transceivers

CAN XL is highly scalable regarding bit-rates and the medium access unit (MAU) physical sub-layer (normally implemented in transceiver chips or system base chips). CAN XL controllers can be used with CAN high-speed and CAN SIC (signal improvement capability, specified in CiA 601-4 version 2.0.0) transceivers using the AUI (attachment unit interface) as specified in ISO 11898-2:2016. Additionally, CAN XL controllers can be used with CAN SIC XL transceivers to support bit-rates of 10 Mbit/s and beyond. To signal the mode switch from the CAN controller to the transceiver, CAN XL controllers and transceivers implement the MICI (medium-independent CAN interface). The MICI is based on a TX-based single-path PWM (pulse width modulation) symbols. This preserves the two-pin interface (RxD, TxD) also for CAN SIC XL transceivers. The specification for MICI is still under development.

Higher-layer protocols

The standardization of higher-layer protocols is essential to enable interoperability of devices with CAN XL connectivity. The CAN XL TF higher layer works for example on the following topics: specification of SDU types, Multi-PDU concept (similar to the concept known from Autosar) that allows to aggregate several different PDUs and to send this as a Multi-PDU inside a single CAN XL MAC frame. Previously, the TF higher layer defined, that CAN XL controllers would use 64-bit time stamps, which cannot wrap around during life time. TF higher layer also requested the introduction of the SDT field and the VCID field in the LLC and XL MAC frame.

Summary

In summary, CAN XL runs in the data phase bit-rates of up to 10 Mbit/s, it provides a data field of 1 byte to 2 048 byte, and it features some embedded layer management information for higher-layer protocols. Important is its backwards compatibility with CAN FD. It is highly scalable regarding the applications but also regarding the sup-

CRC field

Frame CRC	FCP
32 bit	4 bit

ACK field

DAS (DAH, AH1, AL1, AH2)	ACK	Dim
4 bit	1 bit	1 bit

EOF field

End-of-frame
7 bit

Figure 5: XLFF: CRC field, ACK field, and EOF field (Source: CiA)

ported bit-rate, as CAN XL can be used with many different transceivers.

CiA planned to introduce CAN XL on the 17th international CAN Conference that ought to take place in Baden-Baden Germany on March 17 and March 18, 2020. Because of the Covid-19 pandemic the CAN conference could not take place. The CiA technical group SIC CAN XL and its TFs are working intensively on CAN XL in 2020, and expect the release of the first document of the CiA 610 series, CiA 610-1, at the beginning of 2021. After that, the international standardization at ISO will be started. CiA will also organize plugfests (interoperability tests) to test interoperability of CAN XL protocol controllers, but also of the CAN SIC XL transceivers in network environments, as soon as prototypes or engineering samples are available. ◀

References

- [1] CiA 610-1, CAN XL specification and test plan – Part 1: Data link layer and physical coding (in preparation)
- [2] ISO 11898-1:2015, Road vehicles - Controller Area Network (CAN) - Part 1: Data link layer and physical signaling, 2015.
- [3] F. Hartwich, "Introducing CAN XL into CAN Networks" in Proceedings of the 17th international CAN Conference, Baden Baden, Germany, 2020.

Author



Yao Yao
CAN in Automation
yao@can-cia.org
www.can-cia.org



Completely integrated automation for mobile machinery - X90

Complete portfolio:
www.br-automation.com/mobile-automation

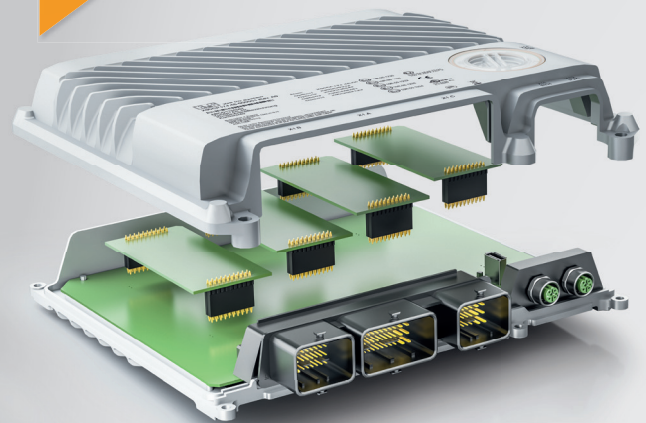

- Easy handling
- Integrated safety
- Faster development



PERFECTION IN AUTOMATION
A MEMBER OF THE ABB GROUP



The physical layer in the CAN XL world

This article explains the CAN SIC XL transceiver approach and concept, the challenges in the networks, and how to combine the CAN XL protocol with the existing CAN FD transceiver, CAN SIC transceiver, and the CAN SIC XL transceiver.

CAN XL as an improvement of the well-established CAN FD protocol increases payload and increases the average bit-rate in a CAN network up to 10 Mbit/s. The CAN protocol was first time published more than 35 years ago and 25 years later, the first discussion about

an improvement called CAN FD was started. After the successful release of the CAN FD protocol, the corresponding physical layer standard specifications and the availability of CAN FD transceivers and micro-controllers supporting CAN FD, it was time to initiate the next level of CAN called CAN XL. The main motivation was to increase the payload. Starting from 8 byte in CAN and up to 64 byte in CAN FD, CAN XL is now doing a big step up to 2 000 byte in the payload.

To reduce the transmitting time for such a big payload, higher bit-rates are needed to achieve acceptable transmitting times. Transmitting a CAN frame with 2 000 byte data with a bit-rate of 500 kbit/s needs 33 ms. A CAN FD frame transmitted with 500 kbit/s in the arbitration phase and 2 000 kbit/s in the data phase and a payload of 2 000 byte data needs more than 8 ms. For automotive applications, this transmitting time for CAN frames is too long and so the target was to achieve a transmitting time below 2 milliseconds. To achieve this transmitting time with 2 000 byte payload, a bit-rate of 10 Mbit/s and higher in the data phase is necessary. 500 kbit/s in the arbitration phase are set to allow the same distances between ECUs (electronic control units) in networks like CAN FD.

The physical layer concept in CAN

The CAN network is a serial bus system and allows more than two nodes connected on a network. In a serial bus system topology with a higher number of nodes, collisions are possible. To manage these collisions, CAN uses the CSMA/CR (Carrier Sense Multiple Access/ Collision Resolution) concept. In the arbitration phase, one or more nodes can transmit a CAN frame on the network at the same time and the node with the highest priority wins the arbitration. To support this CSMA/CR concept, transceivers controlling both levels (TxD=0 and TxD=1) on the network, cannot be used. In case of a collision, the level on the network will be not defined if one transceiver transmits level 0 and the other transceiver transmits level 1 at the same time. During this col-

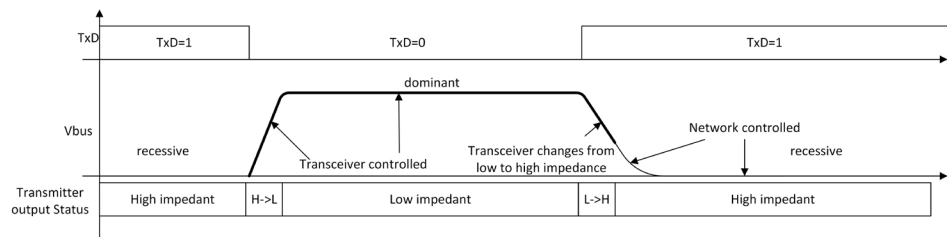

Figure 1: Basic transceiver transmitter concept (Source: Infineon)

lision, the transceiver might be damaged. For that reason, a CAN transceiver controls only one level (TxD=0). This is called dominant level. During the recessive level (TxD=1), the transceiver output stages are high ohmic and the termination resistors are responsible for the recessive state on the network. In figure 1 this behavior is demonstrated. This concept allows a transmitting node to overwrite the recessive state on the network with a dominant level without the risk to damage a transceiver, transmitting a recessive level at the same time. With such a concept, collisions on the network can be supported. The disadvantage is that the transceiver's output stages are changing from high impedance to low impedance and vice versa. This impedance change creates reflection on the network.

Reflection in a CAN topology

In the transmission line theory it is important that the wire impedance and the termination impedance at the end of the wire have the same value. If wire impedance and termination impedance matches, no reflection occurs. If the impedances between the wire and the termination are different, reflection is caused by the different impedances. The formula for reflection is as follows:

$$r = \frac{Z_t - Z_w}{Z_t + Z_w}$$

- ◆ Z_t is the termination impedance and
- ◆ Z_w is the wire impedance.

Table 1: Reflection factor for 120-Ω wire impedance

Termination impedance	Reflection factor
30 Ω	-0,6
40 Ω	-0,5
60 Ω	-0,33
120 Ω	0
100 kΩ (Transceiver input imp.)	+0,99

In table 1 some numbers for the reflection factors are shown. For termination impedances smaller than the wire impedance, the wave will be reflected at the end of the wire and changes the polarity. If the end of a wire is terminated with a transceiver only (100 kΩ), the wave will be fully reflected with an unchanged polarity. On star points, the impedance changes, too. On a star point with 3 stripes (1 line for the incoming wave and two lines for the outgoing wave) the reflection factor is -0,33. The two outgoing lines are in parallel with two times 120 Ω impedance and the overall impedance for the wave is 60 Ω. These reflections are caused with every transition on a wire, independent if the network levels are changing from dominant to recessive or vice versa. However, there is one difference. In case of a recessive to dominant transition, the reflection will be damped by the low ohmic transceiver output stages. In case of the dominant to recessive transition, the network is high ohmic and the reflections fade. The length of the fading phase depends on the wire length and the number of stripes. A long fading phase limits the maximum bit-rate in the data phase because the sampling point has to be set after the fading is finished in order to get a reliable sampling. To realize higher bit-rates, the number of ringing must be reduced and thus the transition from dominant to recessive has to be controlled by the transceiver. This is the concept of the new CAN SIC (signal improvement capability) transceiver.

Two different solutions are available to support the SIC concept based on the specification CiA 601-4,

- ◆ transmitter (Tx) based concepts and
- ◆ receiver (Rx) based concepts.

Transmitter-based concept

In the Tx-based solution, the transmitter controls actively the dominant to recessive transition and afterward's up to 500 nanoseconds (ns) of the following recessive phase. In case of shorter recessive bits, the transmitter changes from active recessive to dominant directly. If the recessive bit is longer, the transmitter changes from active recessive to passive recessive (high ohmic) state like in standard CAN FD transceiver. With CAN SIC transceiver, up to 5 Mbit/s in star topologies and 8 Mbit/s in linear topologies are possible.

Receiver-based concept

In the Rx-based solution, all nodes suppress the recessive signal after the dominant to recessive transition, triggered by the internal receiver. The suppression time de-

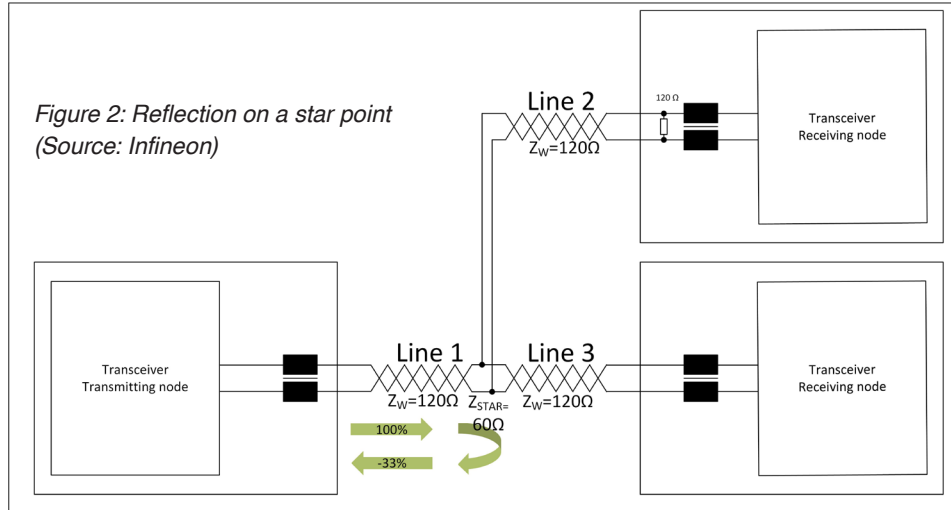

Figure 2: Reflection on a star point (Source: Infineon)

pendes on the product and is optimized for one bit rate. For example for 2 Mbit/s, the transceiver suppression time is up to 450 ns long.

Performance of SIC transceiver

To achieve higher bit-rates, concept independent, the symmetry parameter of CAN SIC transceiver are improved. The new parameters are shown in table 2. The maximum values are the same as in ISO 11898-2:2016, but all minimum values are reduced and allow higher bit-rates. Figure 3 shows the effect for 5 Mbit/s. The tailored parameters reduce the range of asymmetry dramatically and extend the range for network effects and the sample point position.

Table 2: CAN FD and CAN SIC parameter

Parameter	CAN FD TrX ISO11898-2		CAN SIC TrX CiA 601-4	
	Min	Max	Min	Max
Transmitted recessive bit width	① -45ns	⑨ +10ns	① -10ns	⑨ +10ns
Receiver timing symmetry	② -45ns	⑧ +15ns	② -20ns	⑨ +15ns
Received Recessive bit width	-80ns	+20ns	-30ns	+20ns

The main impact is coming from the reduction of the minimum limits for transmitted recessive bit width, changing from -45 ns to -10 ns and the reduction of the receiver symmetry minimum value, changing from -45 ns to -20 ns.

A general disadvantage of the CAN FD and CAN SIC physical layer concept is the asymmetric distance between transmitter levels and receiver thresholds. The distance from the recessive level to the highest possible receiver threshold is 900 mV (millivolt) and the distance from the typical dominant level to the lowest receiver threshold is 1,5 V. This difference causes conceptual asymmetry for

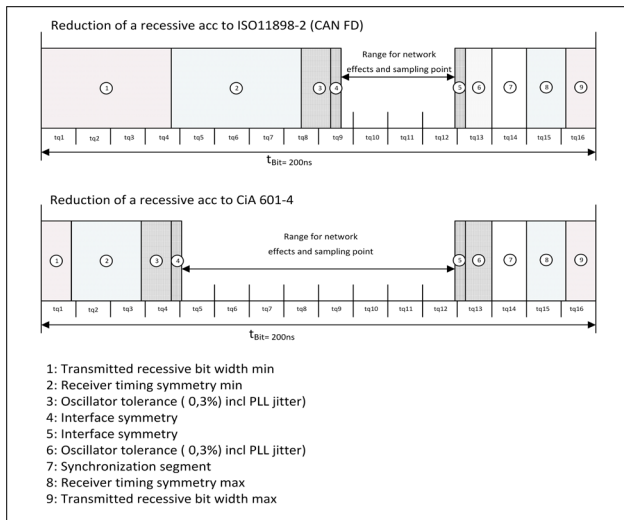

Figure 3: Bit asymmetry for CAN FD and CAN SIC (Source: Infineon)

the timings. To achieve bit rates above 5 Mbit/s, another transmitter concept in the data phase is necessary.

The main targets for the CAN SIC XL transmitter concepts are:

- ◆ Support of CSMA/CR and minimum 500 kbit/s in the arbitration phase
- ◆ Same pinning like for CAN FD transceiver
- ◆ Support minimum 10 Mbit/s in the data phase or more
- ◆ Reduce the timing asymmetry in data phase

To cover all these requirements for the arbitration phase, the CAN SIC concept is used. In the data phase, an alternating network voltage concept is chosen based on the Flexray idea. The advantage of the Flexray concept is that the levels are symmetric to ground and the receiver thresholds. The impedances of both levels are close to the wire impedance (less reflection) and the timing asymmetries are very small. The new CAN SIC XL transceiver has now two modes instead of one mode like implemented in CAN and CAN FD transceiver. The new modes are:

- ◆ The slow mode (arbitration phase)
- ◆ The slow mode is used in the arbitration phase and based on the CAN SIC transceiver concept. All parameters are accordance with CiA 601-4.
- ◆ The fast mode (data phase)
- ◆ In the fast mode, the transceiver controls both levels. The network levels (V_{diff}) are alternating between +1 V (level 0) and -1 V (level 1)

The new fast mode

In fast mode, the transmitter concept changes completely, compared to the established HS CAN and CAN FD transceiver. The output signal will be transmitted as symmetric alternating differential signal. The new levels are named

- ◆ Level0 if Tx0
- ◆ Level1 if Tx1

The receiver threshold is 0 V with a tolerance of ± 100 mV. The output levels are now symmetric to the receiver threshold and reduces the timing asymmetries of transmitter and receiver.

The output impedance of the transmitter output stage will be 105Ω for both levels and fits to most used unshielded twisted pair wires. For CAN SIC transceiver the output impedances are different for dominant state and active recessive state, and not specified in a standard specification. Transmitter output stage impedances matching with the wire impedances and reduces the reflection in a network too. All these parameter are specified in the CiA 610-3 specification. This specification will be released end of 2020.

The SIC transceiver mode changes

The transceiver modes are controlled by the CAN XL controller. Without a mode change, the transceiver can be used as a CAN SIC transceiver only. That allows using the CAN SIC XL transceiver in combination with a CAN FD and/or CAN XL protocol. In the CAN XL protocol two fields are reserved for the transceiver mode switch:

- ◆ The ADS field (arbitration to data switch)
- ◆ The DAS field (data to arbitration switch)

The ADS field is a part of the control field and located after the arbitration field and before the data field. The ADS field consists of four bits:

- ◆ ADH (A=arbitration bit-rate), TxD=1
- ◆ DH1 (D=data bit-rate), TxD=1
- ◆ DH2 (D=data bit-rate), TxD=1
- ◆ DL1 (D=data bit-rate), TxD=0

ADH is transmitted in arbitration bit-rate and during this bit, the transceiver will be switched from slow mode into fast mode. The ADH bit is a recessive bit but at first the network level stays dominant, and after the mode change command from the CAN XL controller, the CAN SIC XL transceiver changes from dominant to recessive level with SIC performance and after a defined time the network level changes from recessive level to level 1. In parallel the CAN SIC XL transceiver switches the receiver thresholds from slow mode threshold levels to fast mode threshold. DH1, DH2, and DL1 are transmitted with the data bit-rate and will be used in the CAN controller for synchronization.

The DAS field is a part of the acknowledge field and located between the CRC field and the EOF field. The DAS field consists of four bits

- ◆ DAH (A=arbitration bit-rate); TxD=1
- ◆ AH1 (A=arbitration bit-rate); TxD=1
- ◆ AH2 (A=arbitration bit-rate); TxD=1
- ◆ AL1 (A=arbitration bit-rate); TxD=1

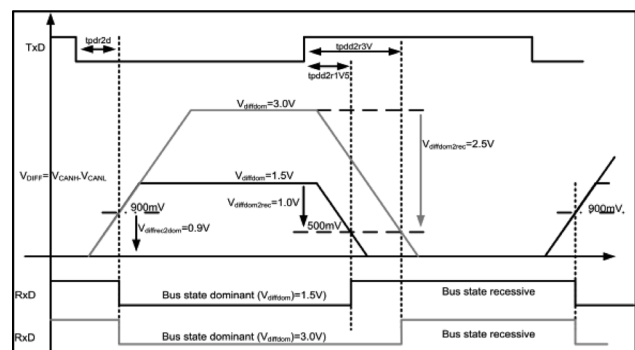
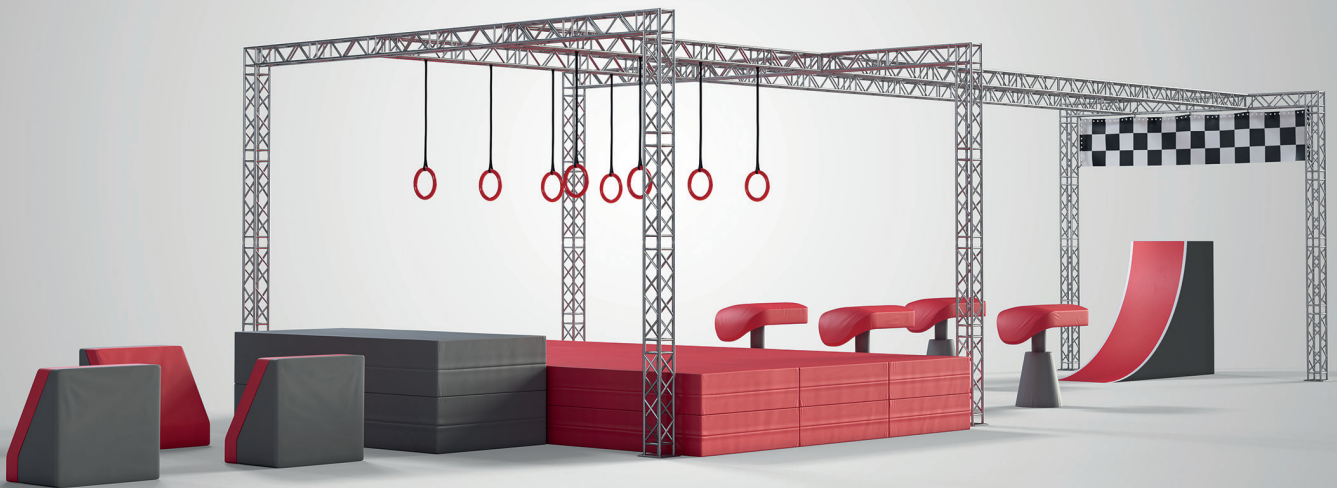

Figure 4: Bit asymmetry caused by dominant level variation (Source: Infineon)

Vector Testing Solution

It's Good If Your Software Runs.
And Even Better If It Conquers
Every Challenge.



Outstanding Software Quality Demands Rigorous Testing.

For embedded software to be successful, it must meet the highest demands. Our comprehensive test solution enables your software project to effortlessly pass every efficiency test. From the design and implementation of the test to its execution, along with the centralized administration and analysis of your test data – we cover the whole gamut, whether for unit or system tests, SIL or HIL. This allows you to always be on the safe side and identify potential improvements for your software at an early stage. And to conquer every challenge with ease.

Vector brings your software development a giant leap forward.

vector.com/testing-solution

VECTOR 

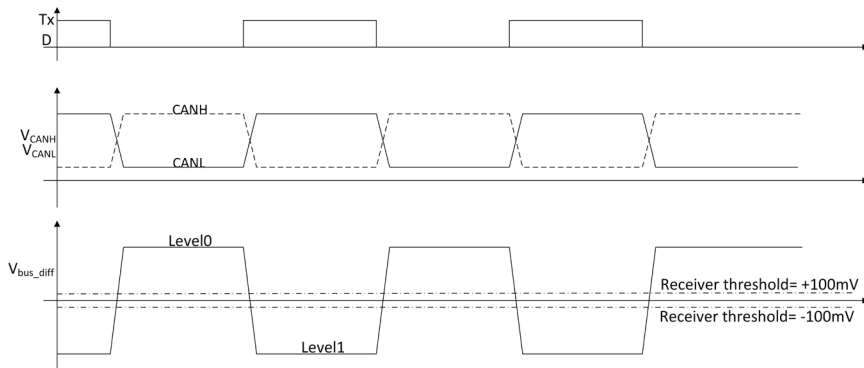

Figure 5: Bus signals in the fast mode (data-phase) (Source: Infineon)

All bits in the DAS field are transmitted in arbitration bit-rate. During the DAH bit, the transceiver will be switched from fast to slow mode. At the beginning of the DAH bit, triggered by the CAN XL controllers mode change command, transmitter changes from level 0 to active recessive and after the signal improvement time the transmitter changes from active recessive to passive recessive. In parallel, the receiver thresholds will be switched from fast to slow mode threshold level. The edge AH1 to AL1 is used in the CAN XL controller for synchronization in the arbitration bit-rate.

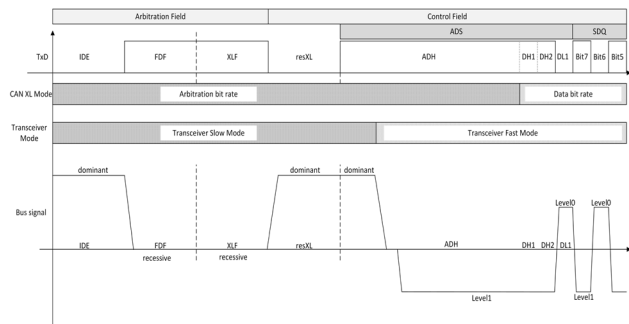

Figure 6: ADS (arbitration to data) field (Source: Infineon)

Transceiver versus protocol

Most of the users have a strong link in mind between the protocol and the corresponding kind of transceiver (see figure 8). But much more combinations are possible like shown in figure 9. For the choice of the transceiver concept two topics are important:

- ◆ The maximum required bit-rate
- ◆ The network topology

The protocol has a minor impact on the choice. The exception is, when the dual mode of the DM-SIC transceiver should be used to achieve bit-rates above 5 Mbit/s or to

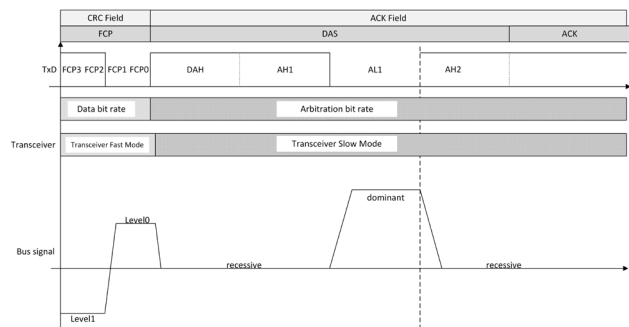

Figure 7: DAS (data to arbitration) field (Source: Infineon)

improve the signal integrity at lower bit-rates. In this case the CAN XL controller is necessary. Only this controller is able to support the dual mode function in the transceiver. The CAN SIC XL transceiver can also be used in combination with CAN FD and the Classical CAN protocol. But in this combinations the slow mode will be supported only. Below, possible combinations are listed.

- For CAN FD protocol:
- ◆ HS-CAN transceiver
 - ◆ CAN FD transceiver
 - ◆ CAN SIC transceiver
 - ◆ CAN SIC XL (slow mode)
- For CAN XL protocol:
- ◆ HS-CAN transceiver
 - ◆ CAN FD
 - ◆ CAN SIC transceiver
 - ◆ CAN SIC XL (dual mode)

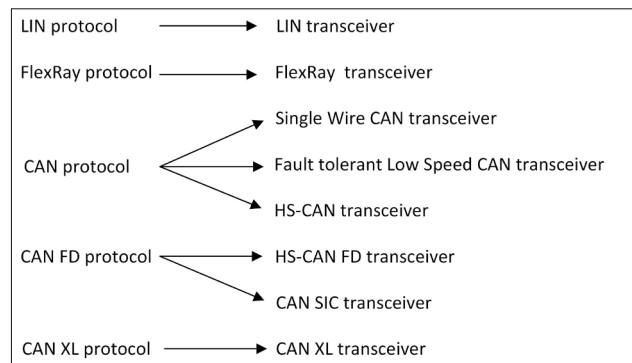

Figure 8: Protocol vs transceiver (Source: Infineon)

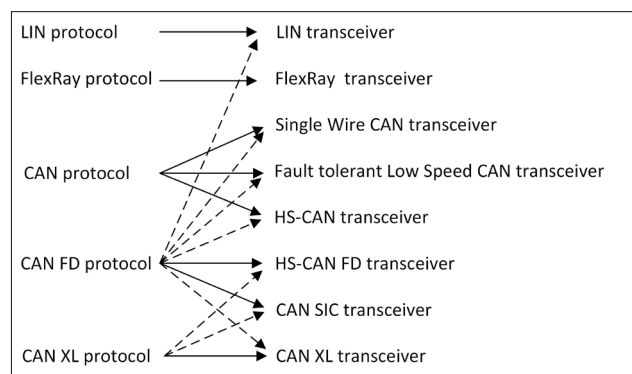

Figure 9: Protocol vs transceiver combination (Source: Infineon)

Our proposal for the transceiver choice

In figure 10 recommendation for applicable bit-rates of the different types of transceiver are shown. The maximum bit-rate depends on the network topologies. As higher the number of stubs, stars, and nodes, as lower the maximum possible bit-rates are. Also, the ratio between the stubs of a star has

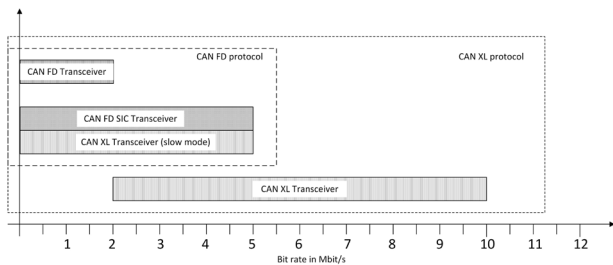

Figure 10: Transceiver application area (Source: Infineon)

an impact of the reflection and the ringing in the network. With the CAN FD and CAN XL protocol and the CAN FD, CAN SIC, and CAN SIC XL transceiver, a lot of possibilities are given now to achieve the best choice for your application. But the higher bit-rates need a very detailed analysis of the network. This can be achieved best by doing network simulations.

Remark

This article describes the status of the specification discussions in September 2020. Modifications are possible. Updates are available on the [CiA homepage](#).

CAN XL specifications

The planned CAN XL specifications include:

- ◆ CiA 610-1: Datalink layer and physical signaling requirements
- ◆ CiA 610-2: Datalink layer and physical signaling conformance test plan
- ◆ CiA 610-3: Physical media attachment sub-layer requirements
- ◆ CiA 610-4: Physical media attachment sub-layer conformance test plan
- ◆ CiA 610-6: Media independent CAN interface conformance test plan
- ◆ CiA 610-7: Higher-layer function requirements
- ◆ CiA 610-8: Higher-layer function conformance test plan

After the release of this specifications, they will be transferred into ISO standards. Start of this transition is planned 2021.

References

- [1] CiA 601-4, Node and System Design Part 4: Signal Improvement. Version: 2.0.
- [2] ISO 11898-2:2016, Road vehicles – Controller Area Network Part 2: High – Speed-Medium access unit, second edition 2016-12-15
- [3] CiA 610-1, CAN XL protocol specification (in preparation)
- [4] CiA 610-3, CAN XL physical layer specification (in preparation)

Author



Magnus-Maria Hell
 Infineon Technologies
info@infineon.com
www.infineon.com





FAULHABER Motion Control

Feel the Power

With the Motion Controllers of the MC 5004/5005/5010 series, the future of networked production is in your hands.

More at: faulhaber.com/mc/en



WE CREATE MOTION

Facts & Figures

ISO 11898-3 confirmed

ISO has confirmed the standard about the low-speed, fault-tolerant, medium-dependent interface for CAN.

The automotive industry does not use transceivers compliant to this standard for new designs.



CiA has 29 members providing subsea equipment. Most of the host controllers and sensors, meters as well as valve devices comply with the CiA 443 profile. This specification will be systematically reviewed, soon. A motion to Draft Standard status for CiA 443 is intended.



The CANopen profiles for batteries and chargers are under review. There is still the opportunity to add new

functions to these specifications. Several suppliers of battery-powered forklifts make use of them. Delta-Q (Taiwan) is one of the companies, which provide a CiA 419 compliant charger.

CAN XL Logical link control

The LLC (logical link control) frame format has been specified. The field names have been harmonized. The "grey" fields are added by the LLC sub-layer. The upper layers provide the "green" fields (which is so-

Priority ID	RMF	IDE	FDF	XLF	BRS	ESI	SDT	SEC	DLC	VCID	AF	LLC data
11 + 18 bit	1 bit	1 bit	1 bit	1 bit	1 bit	1 bit	8 bit	1 bit	11 bit	8 bit	32 bit	0 to 2048 byte

The SDU type indicates the used higher-layer protocol; the VCID allows running multiple applications using the same SDU type

to-say the payload of the CAN XL data link layer). The LLC service interface

is valid for CAN XL, CAN FD, and Classical CAN implementations.

Legend

- RMF: remote frame
- IDE: identifier extension
- FDF: flexible datarate field
- XLF: extra large field
- BRS: bit-rate switch
- ESI: error state indicator
- SDT: service data unit type
- SEC: DLL security indication
- DLC: data length code
- VCID: virtual CAN network ID
- AF: acceptance field
- LLC data: logical link layer data

CiA member statistics

CiA office has classified the CiA members, in order to provide membership statistics. From the 718 members, 71 are technology enablers providing CAN semiconductors, interface modules, protocol stacks, etc. The major-

ity of members, 392, supply devices. Most of these devices are generic, meaning they can be used in many applications. Others are designed specifically for one dedicated application. For example, CiA has 57 mem-

bers, making elevator-specific devices. There are 25 tool suppliers in the CiA community. CiA collects 78 system providers (original equipment manufacturers) and 193 sub-system manufacturers.

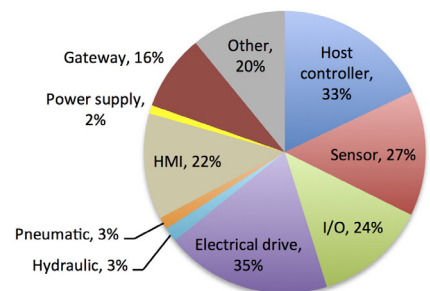

The 392 device-supplying CiA members produce (programmable) host controllers as well as pre-configured units including sensors, actuators, human machine interfaces (HMI), etc. (multiple answers) for different applications

64-bit parameter for drives

The SIG (special interest group) motion control plans to develop a drive profile similar to CiA 402 based on

64-bit parameters. It will be mapped to CANopen FD supporting 64-byte PDOs (process data objects). Par-

ties interested in this specification development are welcome to participate in the SIG's meetings.

TTControl
HYDAC INTERNATIONAL



Vision 3

Enhance human machine interaction

TTControl's rugged operator interface family Vision 3 was specially designed to meet the requirements of the harsh and more and more digitized off-highway environment.

Features like four simultaneous video streams, support of hardware-accelerated 3D animations, user inputs through a multi-touch capable screen and acoustic feedback via an integrated loudspeaker ensure a perfect interaction of the operator with the vehicle for safe and efficient machine operation.

www.ttcontrol.com/vision3
products@ttcontrol.com

CiA's 700th member: Rohde & Schwarz

The 700th CiA member is not a typical one: It is a provider of oscilloscopes, which comes with software for Classical CAN and CAN FD. The company located in Germany supports also other automotive networks including wireless communication.

(Photo: Rohde & Schwarz)

In normal times, CAN in Automation (CiA) would visit its 700th member. However, the coronavirus thwarts this plan. Instead, a virtual meeting was scheduled. I welcomed the company, which was represented by Juergen Meyer, Vice President Market Segment Automotive. By the way, we know each other since about 25 years. In those days, Juergen Meyer was working with Softing, another CiA member. Since three years, he is working at Rohde & Schwarz.

Rohde & Schwarz with its headquarters in Munich has joined CiA, to be up-to-date regarding new CAN lower layer developments, explained Meyer. "We participated as guest in some CAN FD plugfests organized by CiA." Now, the company will participate more actively in the development process of CAN XL. "We like to have first-hand information as early as possible, in order to provide appropriate products. Additionally, we would like to discuss the desires and the wishes of carmakers and their suppliers, to supply features in our oscilloscopes, which our customers really need," added Meyer. "We like to become the market leader in oscilloscopes."

More than 12 000 employees

More than 85 years ago, university friends Dr. Lothar Rohde and Dr. Hermann Schwarz founded Rohde & Schwarz. The company develops instruments for test and measurement. It provides a wide range of electronic capital goods for industry and government customers with a focus on solutions that contribute to a safer and connected world. By the way, I used products from Rohde & Schwarz for the first time, when I was a student.

The privately hold company has more than 12 000 employees and is grouped in four business fields. The market segment automotive belongs to the test and measurement business field. The company started the development of oscilloscopes about ten years ago. Today, it supplies a range of them. Additionally, software packages for Classical CAN and CAN FD are available. In respect to cybersecurity and CAN-based networks, Rohde & Schwarz cooperates with Vector Informatik – another CiA member (we [reported already](#) in the CAN Newsletter Online). For high-speed networks such as CAN XL, Rohde & Schwarz does joint developments with Rosenberger.

Oscilloscopes support CAN

All Rohde & Schwarz oscilloscopes support triggering and decoding of CAN data and remote frames. The instruments can process DBC files. For detailed analysis, results can be visualized as color-coded frames and/or in a table format. Errors are identified by means of hardware-accelerated triggers. You can trigger on start-of-frame (SOF) bit, CAN-ID (identifier), data field content, and various error conditions.

Symbolic decoding of CAN-IDs is possible as well as on-screen,

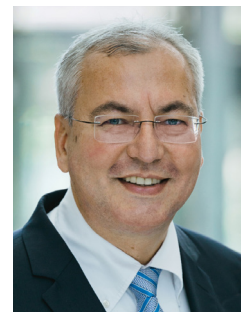

Figure 1: Juergen Meyer stated: "We like to become the market leader in oscilloscopes" (Photo: Rhode & Schwarz)



Figure 2: The portable Scope Rider supports as all other oscilloscopes from the German company Classical CAN and CAN FD (Photo: Rohde & Schwarz)

time-correlated serial decoding with serial data waveforms. The oscilloscopes can show eye-diagram masks to evaluate the physical layer quality. The CAN software package also supports CAN FD.

Most of the CiA members are device suppliers. Toolmakers and instrument suppliers, such as Rohde & Schwarz, are in the minority (29 from more than 720). Most CiA members need such products for development and testing purposes. "Oscilloscopes are necessary to make proper network designs," said Juergen Meyer. "Rohde & Schwarz offers a complete range of instruments from low-end to high-end." In the near future, they will also support CAN XL. "We intend to participate in the CAN XL plugfests," promised Meyer.

Holger Zeltwanger, CiA Managing Director

CAN Newsletter Online: Rohde & Schwarz



In-vehicle networks
Cooperation on timing measurements

Rohde & Schwarz and TSN

Systems have successfully cooperated on precise timing measurements for in-vehicle networks using automotive Ethernet 100BASE-T1. Classical CAN and CAN FD also play a role.

[Read on](#)



CAN Newsletter magazine
Helping out on the race track

Before a race car can hit the track, the electronics must be thoroughly tested. A

CAN-capable oscilloscope from Rohde & Schwarz supports a racing team on this purpose.

[Read on](#)



Portable oscilloscope
For troubleshooting automotive applications

Rohde & Schwarz has enhanced its Scope Rider, adding triggering and decoding software for CAN FD.

[Read on](#)



Embedded World 2018
CAN and LIN oscilloscopes

Beside others, Rohde & Schwarz presents its oscilloscope series' R&S

RTC1000 to the general public at Embedded World 2018. It comes with CAN and LIN support.

[Read on](#)

Ixxat®

BY HMS NETWORKS



NEW!

CANnector

The flexible solution for gateway and logging

- Three use cases with one device – logger, gateway and range extender
- Pre-configured – unpack and get started – but also easy self-configurable and programmable
- Up to 8 CAN(FD), 2 LIN and EtherCAT
- Easy to use by included and drag&drop based Windows tool
- Data visualization on mobile devices, cloud connection, and much more...

Find out more on www.ixxat.com

HMS Industrial Networks GmbH
Emmy-Noether-Str. 17 · 76131 Karlsruhe
+49 721 989777-000 · info@hms-networks.de
www.hms-networks.de



Industrial battery chargers support CANopen

The Canadian company Delta-Q provides battery chargers dedicated for on-board integration in electrical vehicles. The charging process of lead-acid and lithium battery packs is controlled and monitored via CANopen.



Figure 1: The CANopen-connectable IC650 charger is available in 24-V_{DC}, 36-V_{DC} and 48-V_{DC} versions (Source: Delta-Q Technologies)

Many OEMs (original equipment manufacturers) of golf cars, lift trucks, aerial work platforms, floor machines, utility vehicles, and scooters, are developing machines that employ lithium batteries. Safety concerns associated with lithium battery usage creates the need for a highly-integrated system using a charger with CANopen-connectivity. For example, the IC650 charger is available in 24-V_{DC}, 36-V_{DC}, and 48-V_{DC} versions and provides 650-W of constant DC (direct count) output power. The company also provides 85-V_{DC} and 120-V_{DC} models to charge batteries with up to 34 cells.

Via the CANopen network the information between the charger and other electric-drive vehicle components (e.g. main vehicle controller) is exchanged. The data is used e.g. to operate safety interlocks, to be displayed on panels, or to be collected by custom service tools. The CAN interface is galvanically isolated. CAN cable harnesses can be provided by Delta-Q, or sourced by an OEM customer.

The charger's CANopen interface complies with the CiA 419 CANopen device profile for chargers. The battery module to be charged supports the CiA 418 CANopen device profile. Both profiles were specified by CAN in Automation (CiA) and its member-companies. If a CANopen profile is

implemented, the data of the device is accessible via the CANopen network in a standardized manner. The same CANopen interface can be used for all charger variants independent of the charging technique and the power range. Compliant devices may be integrated into CANopen applications from different manufacturers. Delta-Q has also added manufacturer-specific parameters to allow more control and monitoring functionality than specified in the profiles. By default, the CANopen devices use the following settings. The bit-rate is 125 kbit/s. The charger node-ID is set to 10 and the battery node-ID is set to 1. The PDO (process data object) mapping as defined in CiA 418 and CiA 419 is preset. If required, J1939 protocol can also be supported by those chargers.

In the CANopen network the BMS (battery management system) controls the charging process, and monitors individual cell voltages and temperatures. This monitoring and control prevent overcharging and ensures that the battery cells remain balanced. ◀

Author



Olga Fischer
CAN Newsletter
pr@can-cia.org
www.can-newsletter.org

CANopen device profiles for batteries and chargers

The CiA 418 and CiA 419 CANopen device profiles specify the data to be exchanged between a battery module and a battery charger to perform charging. CiA 418 defines the application data to be implemented on the battery module. A compliant battery provides at least the information about the battery type, capacity, number of cells, maximum permissible charge current, and the battery temperature. Additional information may include e.g. the charge history, battery voltage, state-of-charge, requested current, etc. Compliant batteries have to support TPDO 1 (transmit process data object) and RPDO 1 (receive process data object) to exchange mandatory data.

The purpose of the CiA-419-compliant charger is to provide a CiA-418 battery module with the required information to perform charging. The battery status, charger status, and the battery pack temperature is the mandatory

information to be implemented. Additionally, the delivered Ampere-hours, battery voltage, requested charge current, state-of-charge values (for battery and charger), etc. can be supported. Via TPDO 1 and RPDO 1 the mandatory information is exchanged. The COB-ID (communication object identifier) parameters of the PDOs are configured dynamically. Therefore, the charger scans the network for a battery by reading the object 1000_h of the connected nodes. If a battery module is detected, the charger reads the configured COB-IDs of the PDOs and assigns these values to its PDOs correspondingly.

Battery modules and chargers compliant to the CANopen device profiles use the communication techniques as specified in the CANopen application layer and communication profile (CiA 301). CiA 301, CiA 418, and CiA 419 can be downloaded free of charge from the [CiA's website](http://www.can-cia.org).

CANopen-based motion control systems rely on Kvaser Mini PCI Express boards

Communicate with and configure your CANopen application securely using Kvaser's CAN interfaces and software from our Technical Associates.

- A true fit-and-forget solution: Swedish-made hardware, with high-performance features and exacting production, ensures long-term reliability.
- Enclosed interfaces or PCI-based boards for embedded networking: the choice is yours.
- A free, universal and forward-compatible API simplifies software integration.
- A global network of technical associates offers expertise in CANopen, CANopen FD, software and system-design.



Watch the Webinar
CANopen Motion Control: A CAN-based strategy for motion control.
Presented by Copley Controls
kvaser.com/canopen



Kvaser Mini PCI Express 2xHS v2

Injector and scanner communication

After release of the CAN FD based CiA 1301 (CANopen FD) specification in 2017, it is time to look at the benefits, which can be offered for communication between injector and scanner as defined in CiA 425-1 and CiA 425-2 for CANopen.

Compared with the Classical CAN (ISO 11898-1:2003), CAN FD (ISO 11898-1:2015[1]) offers the following improvements. It supports bit-rates higher than 1 Mbit/s (up to 5 Mbit/s are currently specified). CAN FD supports payloads longer than 8 byte (up to 64 byte). CAN FD (CAN with flexible data-rate) frames can use a lower bit-rate during the arbitration phase, and switch to a pre-determined higher bit-rate during the data phase.

Compared to CANopen (CiA 301, based on Classical CAN as the data link layer), CANopen FD (CiA 1301, based on CAN FD) has the following aspects improved:

- ◆ CiA 1301 revamps the classic SDO (service data object) services, which were limited to unicast within the local CAN network. The new SDO service is called USDO (universal SDO), which additionally supports remote services in unicast and broadcast. A remote service refers to a USDO client requesting a USDO upload or download from one USDO server (unicast) beyond the local CAN FD network or all USDO servers (broadcast) in all CAN FD networks inter-connected via CAN FD routers.
- ◆ CiA 1301 supports PDOs of up to 64 byte in payload length.
- ◆ CiA 1301 extends the EMCY protocol from 8 byte to 20 byte, carrying more error-relevant information (e.g. time-stamp).

CAN FD

A Classical CAN data frame and a CAN FD data frame of the base format (11-bit CAN-ID) at the MAC (medium access control) sub-layer of the DLL (data link layer) are shown in table 1 and table 2. The related acronyms are shown in table 3.

Table 1: Classical CAN MAC data frame (Source: Bayer)

Field	SOF	Arbitration		Control				Payload	CRC		ACK		EOF	IFS
		CAN-ID	RTR	IDE	r0	DLC		crc sequence	del	ack	del			
Code	0	xxxx xxxx xxx	0	0	0	0 - 1000	xxxx...x	xxxx...x	1	1	1	1111 111	111...	
Bits*	1	11	1	1	1	4	0 - 64	15	1	1	1	7	≥ 3	

* Number of bits before bit-stuffing

Table 2: CAN FD MAC data frame (Source: Bayer)

Field	SOF	Arbitration		Control				Payload	CRC		ACK		EOF	IFS		
		CAN-ID	r1	IDE	FD	r0	BRS	ESI	DLC	crc sequence	del	ack	del			
Code	0	xxxx xxxx xxx	0	0	1	0	x	x	0 - 1111	xxxx...x	xxxx...x	1	1	1	1111 111	111...
Bits*	1	11	1	1	1	1	1	1	4	0 - 512	17 or 21	1	1	1	7	≥ 3
Phase		Arbitration Phase								Data Phase				Arbitration Phase		

* Number of bits before bit-stuffing

Table 3: Acronym description for table 1 and table 2 (Source: Bayer)

Acronym	Description	Acronym	Description
ACK	Acknowledgement	FD	FD format
BRS	Bit rate switch	IDE	Identifier extension
CRC	Cyclic redundancy check	IFS	Inter-frame space
DLC	Data length code	RTR	Remote transmission request
EOF	End of frame	SOF	Start of frame
ESI	Error state indicator		

The RTR bit at end of the arbitration field in Classical CAN is transmitted dominant (0) in data frames, and recessive (1) in remote frames. In CAN FD, however, remote frames are no longer supported, so the RTR bit becomes reserved (r1), and CAN FD transmitters always transmit this bit dominant.

In Classical CAN, the control field takes up six bits: 1-bit IDE, 1-bit reserved (r0), and 4-bit DLC. CAN FD extends the control field to nine bits (highlighted in table 2) and uses the reserved bit for the FDF. In Classical CAN and CAN FD, a reserved bit is transmitted as a dominant bit. In CAN FD, the FDF bit is recessive. This is how a CAN FD controller can differentiate between a Classical CAN data frame and a CAN FD data frame, so that a CAN FD controller can “downgrade” into a CAN controller able to receive Classical CAN data frames. A Classical CAN controller is not able to handle CAN FD frames. It can be implemented, however, to tolerate CAN FD frames.

The three new bits are 1-bit reserved (r0), 1-bit BRS, and 1-bit ESI. If BRS is dominant, no bit-rate switch occurs for the data phase. Otherwise a higher bit-rate is used for the data phase. The ESI bit represents the error state of the transmitter, with dominant bit as error free and recessive bit as error active. In CAN FD, DLC continues to have four bits, which can normally represent a maximum value of 16. Therefore, a special encoding is required (see table 4) to represent payloads longer than 16 byte.

As shown in table 4, not every payload length can be represented. Specifically, the possible payload lengths are 0 to 8, 12, 16, 20, 24, 32, 48, and 64 byte. Any application payload that is not in one of those lengths must be padded with dominant bits to the next length.

In a Classical CAN data frame, the CRC field takes up 16 bit, with a 15-bit CRC sequence and a 1-bit delimiter (del). With payload length increased by 8 times, CAN FD extends the CRC sequence to 17 bit (for payloads of up to 16 byte), or 21 bit (for payloads between 20 and

Table 4: DLC encoding in CAN FD
(Source: Bayer)

DLC (4 bits)				Payload Length (bytes)
DLC3	DLC2	DLC1	DLC0	
0000 – 1000 _b (same as classical CAN)				0 – 8
1	0	0	1	12
1	0	1	0	16
1	0	1	1	20
1	1	0	0	24
1	1	0	1	32
1	1	1	0	48
1	1	1	1	64

64 byte). To further improve transmission reliability, the CRC field is bit-stuffed with a scheme called fixed bit-stuffing. The bit-stuffed CRC sequence is prepended with a stuff-bit counter (SBC), which consists of a 1-bit FSB (fixed stuff bit), 3-bit count (CNT), containing the number of stuff bits in the CRC sequence, and a 1-bit parity (PTY). The CRC sequence also starts with an FSB, followed by a 4-bit CRC segment, then another FSB and 4-bit CRC segment, and so on until all CRC bits are exhausted. The FSB code is always the opposite of its previous bit. This CRC bit-stuffing scheme makes the whole CRC field 28 bit or 33 bit long depending on the payload length, as shown in table 5 and table 6, respectively.

CANopen FD (CiA 1301)

CiA 1301 [2] specifies the basic communication layer on top of the CAN FD data link layer and is the basis for the CANopen FD specifications. There are some differences in comparison with the CiA 301 [3] CANopen specification.

The most significant difference in CiA 1301 is the redesigned SDO (service data object) protocols called USDO (universal SDO). According to CiA 301, up to 128 server SDOs with CAN-IDs defined by objects 1200_h to 127F_h could be configured in an SDO server's OD (object dictionary). Up to 128 client SDOs (CAN-IDs defined in 1280_h to 12FF_h) could be configured as well. The USDO CAN-IDs are not configurable. Therefore, objects 1200_h to 12FF_h are reserved in CiA 1301 (see table 10). Instead, USDO adds the destination address field to its requests and responses. The CAN-ID for a request from a USDO client is always 600_h + client's node-ID, and the CAN-ID for a response from a USDO server is always 580_h + server's node-ID. In case of the USDO abort protocol the CAN-ID 600_h + client node-ID is used, if the USDO client issues the USDO abort transfer. In case a USDO server issues the USDO abort transfer, the CAN-ID is 580_h + server node-ID.

SDO services (in CiA 301) are local (within the same CANopen network) and only possible in unicast (between one SDO client and one SDO server). The USDO additionally supports remote services between different

Table 5: Bit-stuffed CRC field (payload ≤ 16 bytes) (Source: Bayer)

CRC Field	SBC			Bit-stuffed CRC Sequence									Del	
	F	C	P	F	CRC	F	CRC	F	CRC	F	CRC	F		CRC
	S	N	T	S	16-13	S	12-9	S	8-5	S	4-1	S	0	
	B	T	Y	B		B		B		B		B		
Code	x	xxx	x	x	xxxx	x	xxxx	x	xxxx	x	xxxx	x	x	1
Bits	1	3	1	1	4	1	4	1	4	1	4	1	1	1



HIGH-END CONNECTIVITY AND DATA MANAGEMENT

TELEMATICS AND CLOUD SYSTEMS FOR IOT AND SERVICE 4.0

www.s-i-e.de



Continuous digitization for smart vehicles

Modular on-board units with Linux – ready for condition based monitoring. Including flash-over-the-air and embedded diagnostic functionality.

Sontheim IoT Device Manager and IoT Analytics Manager – for a highly secure, comfortable and individual visualization and management of your data.

Telematic ECU – COMhawk® xt





- 

IoT Device Manager and IoT Analytics Manager
- 

Integrated flash-over-the-air functionality
- 

Modular on-board telematics series
- 

Embedded diagnostics functionality
- 

Multi-protocol support (J1939, J2534, UDS, KWP, ...)
- 

Ready for condition based monitoring

Table 6: Bit-stuffed CRC field (20 ≤ payload ≤ 64 bytes) (Source: Bayer)

CRC Field	SBC			Bit-stuffed CRC Sequence												Del
	F S B	C N T	P Y B	F S B	CRC 20-17 S B	F S B	CRC 16-13 S B	F S B	CRC 12-9 S B	F S B	CRC 8-5 S B	F S B	CRC 4-1 S B	F S B	CRC 0	
Code	x	xxx	x	x	xxxx	x	xxxx	x	xxxx	x	xxxx	x	xxxx	x	x	1
Bits	1	3	1	1	4	1	4	1	4	1	4	1	4	1	1	1

CANopen FD networks. The local and remote services are possible in unicast and broadcast. The data sent in one USDO upload response (read data) or a USDO download request (data to be written) can have a size of up to 56 byte. This means a 14 times higher throughput compared to the expedited SDO transfer in CANopen. However, the redesigned USDO protocol proves that CiA 1301 is not backward compatible with CiA 301. Device OEMs (original equipment manufacturer) that plan to upgrade their CAN device to a CAN FD device will have to upgrade their CiA-301-compliant CANopen stack to a CiA-1301-compliant CANopen FD stack.

Table 7: EMCY defined in CiA 301 (Source: Bayer)

Byte	0 - 1	2	3 - 7
Field	error code	error reg	device-specific

A PDO (process data object) in CiA 1301 can carry up to 64 byte of

payload. Since the PDO mapping parameters (0021_h) already allowed up to 64 object elements to be mapped to one PDO in CiA 301, there is no change regarding the PDO mapping parameters. In CiA 1301, the object elements are interpreted as 64 object elements with one-byte length each, instead of one bit as in CiA 301. In other words, the level of granularity for PDO mapping is 8 bit in CiA 1301, and one bit in CiA 301. The PDO communication parameters (0020_h) are not changed either.

Table 8: EMCY defined in CiA 1301 (Source: Bayer)

Byte	0	1	2 - 3	4 - 5	6	7 - 11	12	13	14 - 19
Field	LDN	r0	CiA spec number	error code	error reg	device-specific	status	r1	timestamp

LDN – logical device number (01 to 0B_h)

The EMCY (emergency message) as defined in CiA 301 is 8 byte long. In CiA 1301, the 20-byte EMCY (see table 8) carries more information about errors. The status field (byte 12, see table 9) provides the information about the EMCY error state (occurred or removed), classification (recoverable or not), and priority. If available, the timestamp contains the time of the error occurrence.

The differences in the object dictionary layout between CiA 301 and CiA 1301 are summarized in table 10.

CiA 425-1 and CiA 425-2

CiA 425-1 [4] and CiA 425-2 [5] specify the application profile for injectors in the medical field, using CANopen as the underlying communication layer. If CANopen FD would be used, which benefits would it have for the injector and scanner applications? A higher bit-rate and a longer payload would contribute to a higher message throughput. But the bit-rate for the communication between an injector and a scanner is not as demanding as in other fields. Therefore, this section will focus on the longer payload.

Heartbeat and emergency

CANopen FD supports heartbeat as the only error control mechanism. This has no impact on CiA 425, as it already defines heartbeat as the acceptable error control mechanism.

CiA 425-2 defines the lower two bytes of the EMCY's 5-byte device-specific field (see table 7 and table 11). One byte provides the error classification and the other points to a sub-index of the object 6060_h (error text). The latter provides a short description of the EMCY error code.

In CiA 1301, the error classification is a part of the EMCY protocol (see table 8 and table 9). Thus, the error classification byte in the device-specific field (CiA 425-2) would become redundant (even though the CiA 1301 error classification does not specify the warning class).

As EMCY error codes are all pre-defined in CiA 301 and CiA 425-2 specifications, and their meanings are well understood both by injectors and scanners, 6060_h is usually not supported in the injector's OD. This is also due to the fact that even a short error text in Unicode string requires to use the block SDO transfer. Therefore, this pointer byte was never used. In CiA 1301, an expedited USDO can carry a maximum of 56 byte of data, which converts to 28 Unicode characters, still too short for a meaningful error description. So, it is still unlikely that injector OEMs would support object 6060_h even in the age of CANopen FD. Therefore, the EMCY as defined in CiA 1301 can be directly used in CANopen FD applications without losing any critical information that was specifically defined by CiA 425-2.

PDO transfer improvement

First of all, none of the PDOs defined by CiA 425-2 is allowed to be RTR-triggered. Specifically, TPDO 2, TPDO 3, and TPDO 4 are timer-triggered. Thus, it would make no difference for CiA 425-2 compliant applications that the RTR bit (remote transmission request) is not supported by CAN FD. As the PDOs in CANopen FD can transmit up to 64 byte, the TPDO 2, TPDO 3, and TPDO 4 (22 byte in total, timer-triggered) could be defined as TPDO 2 (or a new TPDO). This would significantly improve the CAN traffic and simplify the scanner's message handling. Currently, these TPDOs are independently sent to the scanner periodically (frequently during an injection) and could (in each cycle) all arrive very close to each other if not at the same time.

Potential USDO usage

The expedited USDO can transfer a maximum of 56 byte of data in one transmission. Some of the

Table 9: EMCY status bit layout (Source: Bayer)

Bit	7	6	5	4	3	2	1	0
Field	reserved		error state	error class	error priority			
Code	0		0 1	0 1	0 - 7 _h			
					0 - highest, to 7 - lowest			
					0 - recoverable 1 - non-recoverable			
			0 - error removed 1 - error occurred					

Table 10: Object dictionary changes (Source: Bayer)

Object		CiA 301	CiA 1301
1000 _h	Device type	VAR	ARRAY
1001 _h	Error register	generic error	error FSA state
1003 _h	Pre-defined error field*	defined	reserved
100C _h	Guard time	defined	reserved
100D _h	Life time factor	defined	reserved
1021 _h	Store EDS	defined	reserved
1022 _h	Store format	defined	reserved
1030 _h	Version information	not defined	defined
1031 _h	Active error history	not defined	defined
1032 _h	Active error list	not defined	defined
1040 _h	Port network allocation (CAN FD router)	not defined	defined
1041 _h	Routing table (CAN FD router)	not defined	defined
1200 _h	SDO server parameters	defined	reserved
127F _h			
1280 _h	SDO client parameters	defined	reserved
12FF _h			
1F80 _h	NMT startup (NMT master only)	not defined	defined

* 1003_h is replaced with 1031_h and 1032_h by CiA 1301.

objects defined in CiA 425-2 can be restructured to take advantage of it. This object restructuring would be not backward compatible to a CANopen-based injector. But CANopen FD (CiA 1301) is already not backward compatible to CANopen (CiA 301). For example, the mandatory object 1000_h (device type) has been changed from object type “variable” to “array” (see table 10).

Table 11: EMCY defined in CiA 425-2 (Source: Bayer)

Byte	0 - 1	2	3	4	5 - 7
Field	error code	error reg	error class	text ptr	OEM-specific

Object 6003_h (set date and time) is used by the scanner to set the date and time on the injector. But this object is of type “array” with 6 sub-indexes, representing year, day, month, hour, minute and second, respectively. To set the object values requires six SDO download transmissions. When the last transmission is complete, the time (or even date) may no longer be correct. Using CANopen FD, this object could be changed to a variable with the data type Time_of_day (6 byte), which requires one single USDO download transmission. Furthermore, the new type has a precision of milliseconds, which could be crucial in the collaboration between an injector’s log and a scanner’s log in order to trace down communication issues between them.

The injection protocol configuring (or programming) objects (e.g. 6020_h, 6024_h, 6025_h, 6027_h, 6031_h, 6032_h) are “arrays” with each sub-index representing one phase of an injection protocol. Via USDO (e.g. expedited USDO download) a protocol parameter (e.g. flowrate) for all phases of an injection can be transmitted in one transfer. The largest data type used by the mentioned objects is Unsigned32 (e.g. 6027_h). In this case, data for 14 phases can be transmitted in one expedited USDO download. This is still far more than the number of phases, which injectors on the market currently support for one injection.

Currently, proposals for supporting of a multi-injection protocol in CiA 425-2 are under discussion among the participants of the CiA’s SIG (special interest group) injection

Table 12: 6020_h for a multi-injection protocol (Source: Bayer)

6020 _h	Phase 1	Phase 2	Phase 3	...	Phase m
Sub1 Injection 1	Injection	Delay	Injection		
Sub2 Injection 2	Injection	Injection			
...	...				
Subn Injection n	Injection	Injection	Delay	...	Injection

interface. Obviously, future support for the multi-injection protocol will somehow have an impact on these protocol configuring objects. One possible solution is to have these objects remain of type “array”, but with each sub-index representing one injection. Consequently, each of these objects would consist of an array of injections. Each injection would contain all required phases in one sub-index. This concept of object restructuring, using object 6020_h (configured phase type) as an example, is demonstrated in table 12. To note is that one injection may have a different number of phases from the next one in the same injection protocol.

Conclusion

It is only possible for a Classical CAN controller to tolerate CAN FD frames. CANopen FD (CiA 1301) is not backward compatible with CANopen (CiA 301). Replacing a CANopen device with a CANopen FD device requires a new CANopen FD stack. Dropping support for the node-(life-)guarding error control mechanism by CANopen FD has no impact on communications between an injector and a scanner. PDO in CANopen FD can carry up to 64 byte of payload. Thus, TPDO 2, TPDO 3, and TPDO 4 in CiA 425-2 could be merged to one single TPDO to improve CAN traffic and simplify message handling at the scanner’s side. The payload-increase in the USDO transfer also provides the opportunity for objects in the injector’s object dictionary to be restructured so that they can be transmitted more efficiently. Injection protocol configuring objects are good candidates for object restructuring, as they constitute the most intensive SDO transmissions in a typical scanner workflow. The CANopen FD EMCY message transmits more error-relevant information and would be sufficient even without using the device-specific field currently defined in CiA 425-2.

References

- [1] ISO 11898-1:2015: Road vehicles – Controller area network (CAN) – Part 1: Data link layer and physical signaling, 2015
- [2] CiA 1301: CANopen FD application layer and communication profile, v. 1.0.0
- [3] CiA 301: CANopen application layer and communication profile, v 4.2.0
- [4] CiA 425-1: Application profile for medical diagnostic add-on modules, Part 1: General definitions, v. 2.1.0, 2011
- [5] CiA 425-2: Application profile for medical diagnostic add-on modules, Part 2: Injector, v. 2.3.4, 2017

Author



Ron Kong
 Bayer US
ron.kong@bayer.com
www.bayer.us

CANopen devices in J1939 networks

There are many CANopen devices, especially sensors, which are not available with standardized J1939 interfaces. However, J1939 system designers like to use them, in particular in construction machines and similar applications.



(Source: Adobe Stock)

Cranes use heavily encoders and inclinometers, for example. There are many CANopen encoders and inclinometers on the market complying with CiA 406 respectively CiA 410 profile specifications. But some original equipment manufacturers (OEM) are J1939-minded, because they have experience with this CAN-based application layer approach. Therefore, some CANopen sensor suppliers provide manufacturer-specific J1939 interfaces for their products. Interoperability and interchangeability were falling by the sideways.

CiA 406-J and CiA 410-J specifications

This situation could be overcome by mapping CANopen profiles to the J1939 application layer. The idea is simple. The PDOs (process data objects) are mapped to parameter groups (PG) as specified in J1939-21. These 8-byte messages use 29-bit identifiers containing the PGN

(parameter group number). CiA (CAN in Automation) has requested from SAE International dedicated PGNs for encoders and inclinometers. They include the process data as specified in the corresponding CiA 406 respectively CiA 410 profiles. Because J1939 networks are self-starting without the need of a dedicated network manager, the implemented PGs are transmitted after power-on. The sensor behavior is very similar to the default behavior of a CANopen sensor.

Encoders provide by default position values in one PG as well as optionally calculated velocity or acceleration values in other PGs. Inclinometers send their axis angle values in standardized PGs. These PGs use PGNs assigned by SAE, but the details are specified in CiA 406-J respectively (CiA 410-J).

CANopen protocols on J1939

In order to change the behavior, like in CANopen devices, the CiA 406-J and CiA 410-J sensors provide the same configuration parameters. This means, they implement a CANopen dictionary in the J1939 devices. These configuration parameters can be written by means of SDO (service data object) services. These services are mapped to PGs specified in CiA 510. The CAM11 parameter group contains in its 8-byte payload the SDO client/server protocol and the CAM21 parameter group maps the SDO response (server-to-client). This means, the sensors implement partly a CANopen protocol stack, which sends and receives virtually SDOs and PDOs.

Optionally, these J1939 sensors with CANopen behavior provide the EMCY parameter group, which transmits the 8-byte EMCY message as specified in CANopen. This PG provides the standardized 16-bit emergency error code and the 8-bit error register (see CiA 301).

A typical example of configuration is the period of transmission for process data. As mentioned above, there

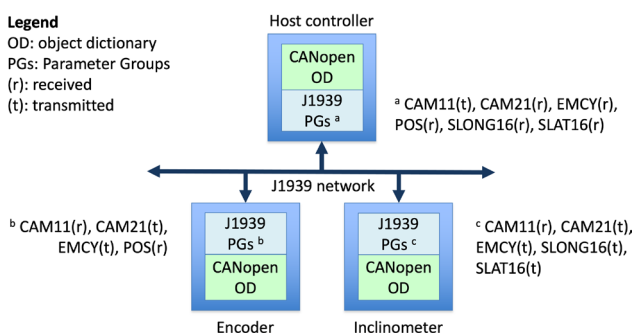

Figure 1: CANopen-compliant sensors such as encoders and inclinometers can be used in J1939 networks, when they implement the parameter groups specified in CiA 510, CiA 406-J respectively CiA 410-J; the CAM11 and CAM21 parameter groups, providing SDO-compliant functions, allow access to the CANopen object dictionaries in the sensors to write and to read parameters and process data (Source: CiA)

are PGs standardized, which transmit encoder or inclinometer values. The transmission period can be configured by means of the CAM11 and CAM21 parameter groups. This can be done by a host controller or by a configuration tool with knowledge of the CiA 406 respectively CiA 410 profile specifications.

In the past, several encoder and inclinometer providers have implemented proprietary PGs for their products. Some of them were even configurable by means of SDO similar mechanisms. But also those were proprietary. With the release to CiA 510 and the J-series of CiA profiles, it is now possible to provide interoperable products for J1939 networks. They are even interchangeable, when they provide the same application features (e.g. dual-axes inclinometer).

Unfortunately, the first Draft Standard Proposals of CiA 406-J and CiA 410-J did not reference correctly the PGNs. This has been corrected in the new versions. Also, CiA 510 has been improved regarding the used terminology and some other minor editorial issues. CiA plans to provide more mappings of its profile specifications for J1939-based networks. ◀

Holger Zeltwanger

All you CAN plug

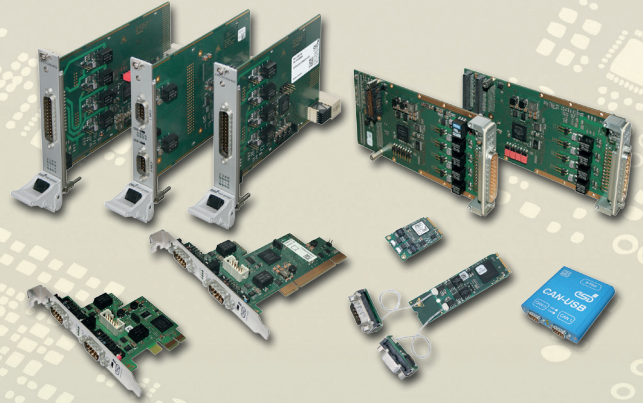

CANopen^{FD}

CAN^{FD}

CAN / CAN FD Interfaces

Product Line 402 with Highspeed FPGA

- **Various Form Factors**
PCI, M.2, PCI Express[®] Mini, PCI Express[®], CompactPCI[®], CompactPCI[®] serial, XMC and PMC, USB, etc.
- **Highspeed FPGA Design**
esdACC: most modern FPGA CAN-Controller for up to 4 channels with DMA
- **Protocol Stacks**
CANopen[®], J1939 and ARINC 825
- **Software Driver Support**
Windows[®], Linux[®], optional Realtime OS: QNX[®], RTX, VxWorks[®], etc.

esd electronics gmbh

Vahrenwalder Straße 207 | D-30165 Hannover
Tel.: +49(0)511 372 98-0
info@esd.eu | www.esd.eu

esd electronics, Inc.

70 Federal Street - Suite #2
Greenfield, MA 01301
Phone: 413-772-3170
www.esd-electronics.us

Quality Products -
Made in Germany



Diagnostic solutions for mobile machines

Use of diagnostic tools allows for a product testing and targeted monitoring over the mobile machine's life cycle. Failures can be detected before actual faults in the communication occur. This helps to avoid costly downtimes.

Today, communication between several mobile machines makes work more comfortable, but it also increases the demands for sensors, electronics, and networking. Unplanned disruptions can occur due to system errors and cause costly downtimes.

Gemac (Germany) offers different solutions for diagnostic of the physical layer parameters and the logical data traffic in the CAN-based in-vehicle-networks of mobile machines. The battery-operated handheld CANTouch diagnostic device is the further development of the CAN-Bus Tester 2 and inherits and exceeds its features. It connects to the CAN network via a cable and is user-friendly with a touchscreen similar to smartphones. Measuring functions are operated interactively via applications ("apps"). The evaluation system uses a combination of traffic light colors and smileys to show the user the measurements' condition. The 4,3-inch color display allows a graphical representation of the measured results. Service technicians can use the device for commissioning, analysis, monitoring, and maintenance works. CAN networks that are diagnosed by the CANTouch, use proprietary and standardized higher-layer protocols such as CANopen, Devicenet, and J1939.

The user can monitor the network for individual physical limits, determine problems over time, and make errors visible in an oscillogram. The measurement results can be archived for documentation or later analysis and processing on a PC. The physical layer measurements include the direct determination of potential differences between the participants (common-mode/ground shift). With this, it measures the absolute signal levels of all CAN nodes relative to its position and determines the widest spread among all nodes, i.e., the "absolute maximum common-mode voltage." Even though the CAN transceivers permit higher values than those specified in the datasheet, higher common-mode voltages can result in communication errors and eventually destroy the CAN transceivers. Sporadic bus interference, such as external EMC (electromagnetic interference) or a slowly deteriorating signal quality attributable to worn out plug connections or cables, can be detected. Thus, the diagnostic devices allow to reveal error sources in the physical network characteristics early and catch errors before actual communication faults occur. "Gemac is the only provider in the world of such diagnostic systems that physically measure and enable comparable statements about the signal quality and interference reserve in the mobile machine," said Ralf Meischner from Technical Support Fieldbus. Users can



Figure 1: Fieldbus diagnostic system CANTouch (Source: Gemac)

diagnose and repair loaders, bulldozers, excavators, and other commercial vehicles and equipment. The tools are also used in mining and other off-highway applications.

In September, the company introduced the Gemac Motus series of inertial measurement units (IMUs) dedicated to mobile machines. Motus comes from Latin and means movement. Gemac Motus provides a high-precision recording and digitalization of movement up to an inclination resolution of 0,01 ° combined with a static accuracy up to 0,1 ° and a dynamic accuracy up to 0,25 °, with an acceleration resolution up to 0,244 mg and a gyroscope resolution up to 0,00875 %/s. This precision guarantees safety when using the IMU in mobile machines.

Gemac realizes this mentioned new level of functionality based on the six-axis motion detection. It measures the 3-axis acceleration and the 3-axis

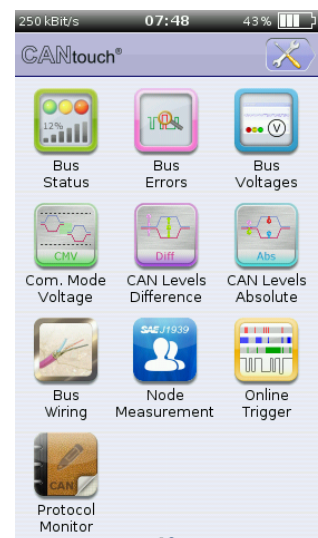

Figure 2: CANTouch user interface uses "apps" (Source: Gemac)

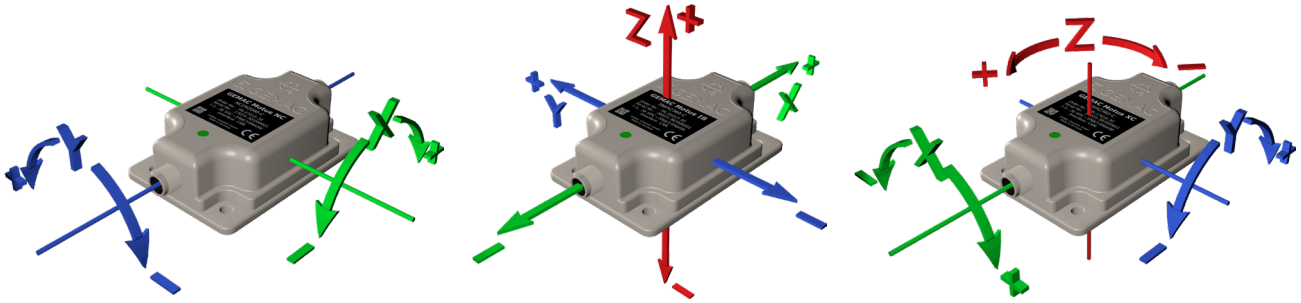

Figure 3: The Gemac Motus IMU measures 2-axis inclination, 3-axis acceleration, and 3-axis rotation rate (Source: Gemac)

rotational rate. Variants with an additional inclinometer are available. Data processing occurs in the measuring unit using a sensor fusion algorithm developed from Gemac. This new algorithm combines and extends the well-known Kalman filter and the Complementary filter, exploiting their advantages and suppressing their disadvantages at the same time. Integrated sensor fusion filters support the user in calculating the vehicle orientation by suppressing external accelerations. Because of the combination of hardware, parameters, and the invited sensor fusion algorithm, the company names the Gemac Motus as the worldwide first Power-IMU for mobile machines.

The IMU is available in 29 different application-related configuration options. It supports CANopen and J1939 higher-layer protocols. The CANopen version implements the CiA 301 (version 4.2.0) CANopen application layer and communication profile. For the inclinometer function, the CANopen device profile for inclinometers

(CiA 410 v. 2.0.0) is supported. The ISD-Control software for the IMU parameterization is available for a free download. It works with CAN adapters from various manufacturers. The units are dedicated for use in construction machinery, agricultural machinery, forest machines, cranes, lifting technology, ships, etc. ◀

Author

Thomas Kießling
 Gemac
info@gemac-chemnitz.de
www.gemac-chemnitz.de

CAN and CAN-FD Products for your requirements



CAN-FD Gateway



Ethernet/CAN Gateway

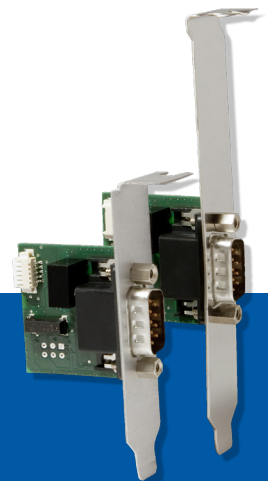

Embedded USB/CAN Interface

- Economical solutions for series applications
- Optimized for industrial applications
- Solutions for stationary and mobile use
- Software support for bus-analysis, measurement and control



Sonnenhang 3
 D-85304 Ilmünster
 Tel.: +49-8441-49 02 60
 Fax: +49-8441-8 18 60
www.ems-wuensche.com

Change in automotive communication systems

The authors take a look on the transformational change of Classical CAN, CAN FD, CAN XL, Flexray, and Ethernet. CAN XL provides the basis for cooperation between IP technology and signal-based communication. It closes the gap between CAN FD and Ethernet.

Just a few years after the market launch of CAN FD, a new CAN variant, CAN XL, is on the start – sometimes viewed with a little suspicion. In fact, CAN XL owes less to the marketing strategy of electronics suppliers than it does to the dynamic development in automotive electronics over the last few years. In particular, the advent of automotive Ethernet with IP technologies is changing some things fundamentally. Currently, service-oriented communication is establishing itself in the vehicle parallel to signal-based communication. In this context, CAN XL provides the basis for efficient cooperation between IP technology and classic, signal-based communication. With data transmission speeds of up to 10 Mbit/s, it closes the gap between CAN FD and 100-Mbit Ethernet (100BASE-T1).

Currently, development departments in the automotive industry are, for the most part, concentrating on the challenges posed by the transformation in mobility. The focus is on assistance systems (ADAS – advanced driver assistance system), autonomous driving, electric mobility, and continuous connectivity to the Internet or to the cloud. High-performance sensor systems such as radar, laser scanners, and video cameras in the vehicle are an indispensable prerequisite for autonomous driving. They generate volumes of data that were unknown in the automotive sector only a few years ago. The challenge is how to transmit and process this exploding data volume in real-time. To meet this challenge, the industry has introduced Automotive Ethernet for fast transmission of data, covering primarily the bandwidths of 100 Mbit/s to 1 000 Mbit/s (100BASE-T1, 1000BASE-T1) used initially in the ADAS area. At the lower end of Ethernet networking, development is currently focused on 10BASE-T1S, with a transmission speed of 10 Mbit/s.

Service-oriented communication goes hand in hand with Ethernet and IP technology. Applications need data and services. It does not matter who provides them. However, this does require

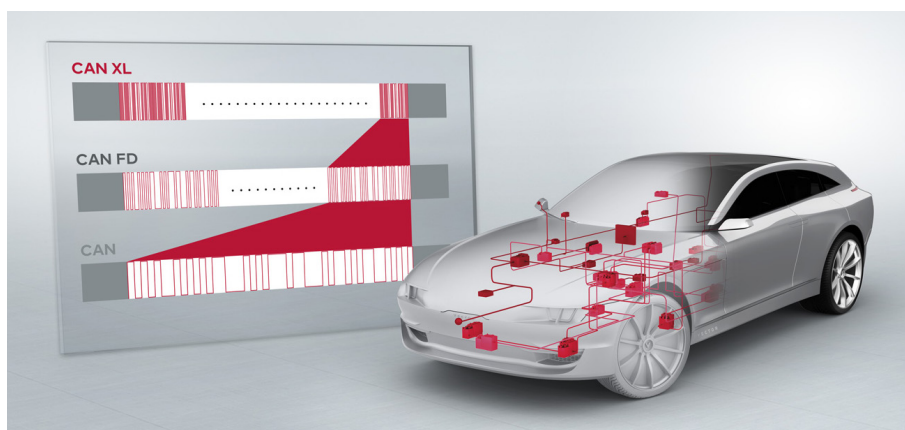

(Source: Vector)

a dynamic link connection between data sink (consumer) and data source (provider). The ability to transmit dynamic data structures is another major advantage of service-oriented communication. The volume of data to be transmitted, for example in the case of sensor data fusion applications, is generated only during the runtime of the application. Such data cannot be mapped statically; instead, the communication system must serialize the data dynamically.

Classic automotive serial bus systems

In contrast, the classic automotive networks such as Classical CAN/CAN FD and Flexray employ signal-based communication technology. In most applications, CAN operates at a transmission rate of 500 kbit/s and is used in automotive areas such as engine management and body control. The capabilities of CAN, a pioneer in automotive networks, are extended upwards by CAN FD and Flexray, whose transmission rates range from 1 Mbit/s to 10 Mbit/s. ▷

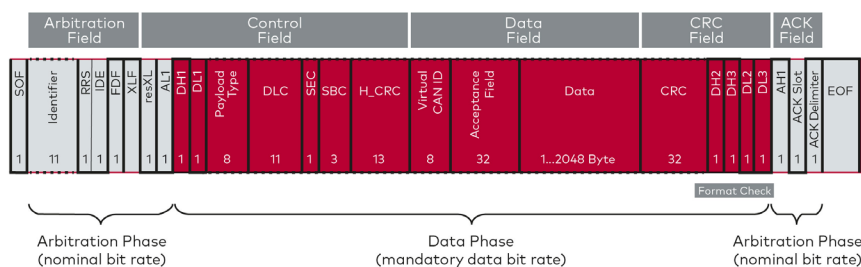
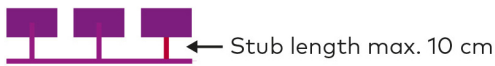

Figure 1: CAN XL frame (current status of development); With data lengths of up to 2 048 byte, CAN XL also lays the groundwork for future transportation of Ethernet frames and for the use of IP communication (Source: Vector Informatik)

Ethernet 10BASE-T1S Line Topology:



CAN Double Star Topology with long Stubs:

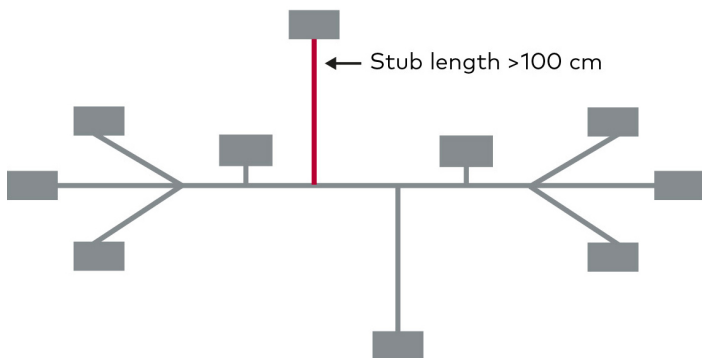

Figure 2: Network topologies of 10BASE-T1S and CAN XL; CAN XL enables other topologies to be used, with a star and long stubs (Source: Vector Informatik)

These newer systems are predestined for time-critical applications in engine management, body control, and chassis control, where they are used, for example, in the brake system. Lastly, Most, which is responsible for infotainment applications, covers the 25 Mbit/s to 150 Mbit/s range.

Given the rise of automotive Ethernet and in view of the growing variety of communication systems, a consolidation

appears reasonable to limit complexity and costs. Since the fields of application of Flexray and Most can also be sufficiently covered by Ethernet, these systems will likely be replaced in the medium term. This would leave CAN and Ethernet, with Ethernet now handling infotainment, ADAS, telematics and connectivity at 100 Mbit/s to 1000 Mbit/s. Classical CAN and CAN FD operate in the range of 0,5 Mbit/s to 5 Mbit/s and are responsible for engine management and body control. In the future, CAN XL or 10BASE-T1S could be used for chassis control systems, running at 10 Mbit/s.

Considering that about 90 % of all network nodes communicate at speeds of up to 10 Mbit/s, the 10 Mbit/s domain covers a wide field of applications. It extends from audio applications to radar and ultrasonic sensors all the way to chassis control. From the technical viewpoint, the first applications mentioned focus on the streaming and serializing of data as well as on the principle of service orientation. In contrast, for applications in chassis control, signal-oriented communication dominates. As indicated above, CAN XL and the Ethernet variant 10BASE-T1S are competing in this sector.

CAN XL – the latest and fastest CAN

CAN XL is a further development of Classical CAN and CAN FD and operates largely on the same principle. A CAN frame can be divided into arbitration and data phases. While CAN XL uses low transmission speeds of 500 kbit/s to 1 Mbit/s in the arbitration phase, the speed in the data phase is ▶

LIN & CAN Tools for Test and Production

Windows/Linux

SPS/PLC

Raspberry Pi

Development

EOL Test

Digital I/O PWM Analog Inputs

USB

Ethernet

RS 232

Digital I/O

Protocols and Services
Raw, DTL, ISO-TP, UDS, etc.

Functionality Identification Configuration Traceability

SecOC Multi-PDU E2E

New Feature

CAN FD (up to 2 channels)

CAN HS (up to 2 channels)

CAN LS

LIN (up to 6 channels)

SINCE 1986

www.lipowsky.com

info@lipowsky.de

+49 6151 93591-0

ISO 9001 : 2015

Distribution China: Hongke Technology Co., Ltd
Distribution USA: FEV North America Inc.

Ph: +86 400 999 3848
Ph: +1 248 293 1300

sales@hkaco.com
marketing_fev@fev.com

www.hkaco.com
www.fev.com



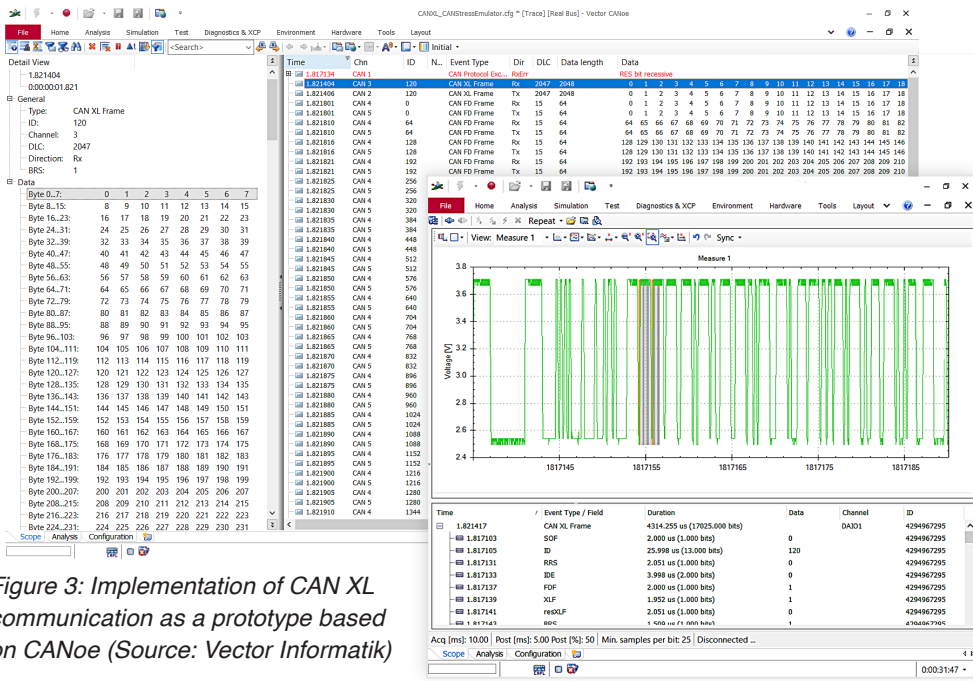

Figure 3: Implementation of CAN XL communication as a prototype based on CANoe (Source: Vector Informatik)

scalable over a wide range of 2 Mbit/s to 10 Mbit/s. This bit-rate-switching is now mandatory with CAN XL.

Once again, the access method used is CSMA/CR (carrier sense multiple access/collision resolution), which resolves competing write access through bit arbitration. In this way, CAN XL follows a strict priority concept that allows the more important frame to be transmitted with no delays. CAN XL now only supports 11-bit identifiers, and 29-bit identifiers are no longer in use. Furthermore, CAN XL features a high level of data transmission reliability. With Hamming Distance 6 for headers and frames as well as format checks, it actually outperforms Flexray and the capabilities of Ethernet CRCs.

However, for future applications, it is not just the increased speed of data transmission that is important. A key motivating factor for the development of CAN XL is also the scalable length of useful data, which can extend to as much as 1 byte to 2 048 byte. Where necessary, this enables future automotive communication systems to package Ethernet frames in CAN XL frames, and/or to use IP communication via CAN XL (figure 1).

Network topology with controlled network access

The new 10BASE-T1S also operates at a transmission speed of 10 Mbit/s. With the automotive 10-Mbit/s Ethernet variant considered here, the “S” stands for short distance or short range and exists explicitly for automotive applications. It covers short distances of up to 25 meters and should not be confused with the 10BASE-T1L variant (L – long distance), which provides ranges of up to 1 000 meters and is typically employed in industrial applications.

An unshielded twisted wire pair serves as physical layer for 10BASE-T1S (“T1”). In contrast to today’s other switched Ethernet versions, the topology for 10BASE-T1S is a network. All users are connected to a common Ethernet cable (multi-drop bus topology) by short tap lines (“stubs”) measuring maximal 10 centimeters in length. This immediately raises the question of network access: In the Ethernet-PHY, a round-robin approach is implemented that allows collision-free network access via PLCA (physical

layer collision avoidance). This guarantees deterministic response times for each network user, and provides real-time capability in the application. Collision-free access further allows complete use of the entire bandwidth of 10 Mbit/s. 10BASE-T1S offers only half-duplex operation, for which only one PHY per ECU (electronic control unit) is needed instead of two per connection.

With these characteristics, 10BASE-T1S is also suitable for applications found in classic automobile

networks. Whereas Ethernet 10BASE-T1S is positioning itself from above in the 10-Mbit/s domain, CAN XL, coming from below, is expanding up into the 10-Mbit/s domain. Both, 10BASE-T1S and CAN XL domains, could frequently operate as network branches under a 100BASE-T1 domain. Coupling of 10BASE-T1S to 100BASE-T1 is possible without problems through use of a switch. In contrast, a gateway is required to connect CAN XL branches. With their different approaches, both models have advantages and disadvantages, and theoretically could exist in parallel to each other. The decision as to which communication system will play a predominant role in this area in the future depends on cost considerations as well as on technical factors and, last but not least, on reverse-compatibility with Classical CAN and CAN FD.

Signal-based CAN communication

A powerful argument for CAN XL remains the high dominance of Classical CAN variants with signal-based communication in numerous vehicles. For typical control tasks, the signal-based approach has been tested and proven for almost three decades. Together, with the priority principle used with CAN, the system ideally satisfies the necessary real-time requirements. A major feature of signal-based communication is the predefined static communication matrix. Signals such as temperatures, pressures, speeds or revolutions always represent the same fixed parameter, which is mapped to an established CAN frame and sent to ECUs (electronic control unit). In addition, so-called PDUs have been introduced, which form an intermediate layer and make communication more flexible.

In contrast to 10BASE-T1S, CAN XL offers the ability to use more complex topologies with a star and long stubs. For this reason, the proven topologies of existing CAN solutions cannot be replaced on a one-to-one basis with 10BASE-T1S networks, given their considerably more restrictive network topology. Their restrictive network topology only permits stubs with a length of 10 cm. On the other hand, nothing stands in the way of upgrading from Classical CAN/CAN FD to CAN XL in this regard, since a great deal of know-how and development time has already been invested in wire routing and the careful design of ingenious cable harnesses (figure 2).

It is precisely this migration path that makes CAN XL interesting for those automakers who focus primarily on compact and midsize cars. In this mass market, autonomous driving will not be found for some time. At best, you will find simple assistance systems that have already been in common use for years, for example anti-lock brake systems. Without radar sensors, high-resolution cameras, and the like, there is no compelling need for an Ethernet-based network; instead, the classic systems will predominate, led of course by CAN. For such vehicles, CAN XL offers the ideal platform for further development on the basis of the existing vehicle architecture. No redesigns of cable harnesses, controllers, and protocol stacks are necessary. The simpler protocol stack for CAN compared to that for IP allows use of smaller and thus lower-cost controllers. One goal for CAN XL would be to continue this tradition.

Summary and prospects

CAN XL is a CAN variant that constitutes a simple migration path for existing Classical CAN and CAN FD networks and that also closes the gap in transmission speeds between Classical CAN/CAN FD and Ethernet. In appropriate fields of application, CAN XL communication can facilitate smaller and therefore less expensive controllers than Ethernet. With useful data lengths of up to 2 048 byte, CAN XL also delivers what will be required in future to transport Ethernet frames and to utilize IP communication. At some future date, this could mean that CAN XL and 10BASE-T1S could together

provide a link between signal-based communication on the lower levels and service-oriented communication on the higher systems. With appropriate extensions in the various protocol layers, this will open up some interesting options. Some very promising initial CAN XL prototypes have already been developed, including ones by Vector (figure 3).

On page 32 ([IP concepts with CAN XL](#)), the authors take a look on the transformational change of communication systems. CAN XL provides the basis for cooperation between IP technology and signal-based communication. It closes the gap between CAN FD and Ethernet. ◀

Authors



Oliver Garnatz, Peter Decker
Vector Informatik
info@vector.com
www.vector.com

This article originally appeared
in Hanser Automotive in
German language.

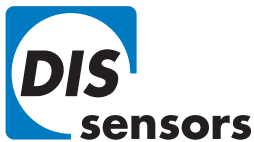

Available now: Dynamic Inclinometer

Stable real-time measurement,
even during rapid movement

DIS makes sense!



www.dis-sensors.com

IP concepts with CAN XL



(Source: Vector)

The authors take a look on IP concepts with CAN XL and the transformation of Some/IP towards Some/CAN. Additionally, this article sets out several options for implementing service-oriented communication with CAN XL.

The networking of future generations of automobiles will be based primarily on use of the various Ethernet and CAN variants. While Ethernet dominates with its service-based IP communication and Some/IP middleware at the level of assistance systems, signal-based CAN networking will continue to exist long into the future in the drive and chassis sector. The new CAN XL should assume an important role in enabling these two fundamentally different concepts to co-exist and to work alongside one another. This raises questions as to whether the CAN XL ECU (electronic control unit) participates in service-based communication, and about the possible ways that might exist for enabling this to happen.

In broad terms, the key technical parameters for CAN XL have been defined: The new CAN variant offers data speeds of up to 10 Mbit/s and, with a variable length of user data in a range of 1 byte to 2 048 byte, it is also capable of transporting complete Ethernet frames inside CAN XL frames. As you would expect, CAN XL is otherwise broadly speaking reverse-compatible with Classical CAN or CAN FD and with the concept of signal-based communication. This is of particular benefit for the further development of electronic architectures for small and compact automobiles for which, at this time, no Ethernet high-performance communication is required for advanced driver assistance systems (ADAS) and autonomous driving. CAN XL makes it possible to continue using existing networking concepts and wiring harnesses without the need for big modifications.

Best of both worlds with CAN XL

Nonetheless, the future will inhabit the realm of service-oriented IP communication with Ethernet, according central significance to Some/IP (scalable service-oriented middleware over IP) middleware with its Some/IP-SD service discovery process. On board vehicles, Some/IP enables dynamic links to be established between providers (data sources) and consumers (data sinks). For modern applications, it does not matter who is supplying data or services.

Service-oriented communication is also in charge of the transmission of dynamic data structures. The volume of data to be transmitted, for example in the case of sensor data fusion applications, is generated only during the runtime of the application. Such data cannot be mapped statically in the way typical of signal-based communication. Instead, the communication system must serialize the data dynamically. The SomeIpXf module is responsible for serialization in the Autosar Classic Platform. Since it is part of the middleware level of Autosar, its functionality can be used to serialize dynamic data for CAN XL as well.

Dynamic link connection

Some/IP supports both, fully dynamic and semi-dynamic link connections. The fully dynamic link connection is used when the network nodes do not know each other's IP and MAC addresses. A few benefits are associated with the establishment of dynamic communication on all protocol ▶

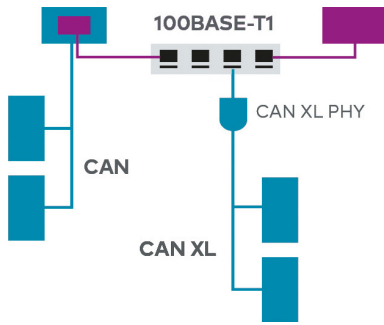

Figure 1: Ethernet CAN network with CAN PHY (Source: Vector Informatik)

levels: A service can be relocated within the network to any other desired node without requiring modifications to the ECU. The same applies to MAC and IP addresses. When required, consumers and providers may make multiple use of the Address Resolution Protocol (ARP) to determine their respective MAC and IP addresses.

Likewise, there are reasons in favor of a semi-dynamic link connection with static IP addresses and MAC addresses. Each ECU has a mapping table in which the IP and MAC addresses of the other network nodes are saved. This method also establishes dynamic communication on the service level during runtime, but allows communication to start faster because it can do so without ARP. With a semi-dynamic link connection, services can also be moved arbitrarily because all IP and MAC addresses are known. The drawback here is that IP/MAC addresses can now no longer be changed. In this case, the mapping tables in all ECUs involved would also have to be updated. What is important to know is that, depending on the vehicle or model series, the industry sometimes uses fully dynamic and sometimes semi-dynamic link connections. Some/IP works with every Ethernet variant, regardless of whether it only involves switched networks or ones with network topology.

Service-oriented communication on CAN XL

To do justice to its role as the link element between Ethernet and CAN domains, CAN XL should also be able to participate in service-oriented communication. It is therefore of great interest to the designers of future E/E architectures to establish which options CAN XL can offer to this in technical terms. At the same time, users continuously strive to find the most cost-effective solution. A crucial factor in this is to establish which requirements individual solutions impose on the software stack and on the ECU hardware.

The first possibility is to route Ethernet frames on CAN XL. To this end, a standard Ethernet switch can be used. On the hardware side, it is necessary to develop and then incorporate a CAN XL PHY between the port to which the CAN XL network is attached and the CAN XL network. The CAN XL PHY should be able to copy all of the Ethernet frames to CAN XL frames and vice versa – depending on the direction of communication. It is needed only at the Ethernet switch, while at the CAN XL nodes commonly used transceivers suffice. Of course, it is also always possible to use a conventional gateway (figure 1).

The demands on the CAN XL stack are considerably higher. As soon as Ethernet frames can be incorporated in CAN XL, a common TCP/IP stack will also be required in the CAN XL ECU. Keep in mind: Embedded in the CAN XL frame is an Ethernet frame, which also contains an IP packet. The interface layer, in turn, must be able to accommodate the behavior of CAN as well as that of Ethernet. The CAN part of the interface layer unpacks the Ethernet frame, while the

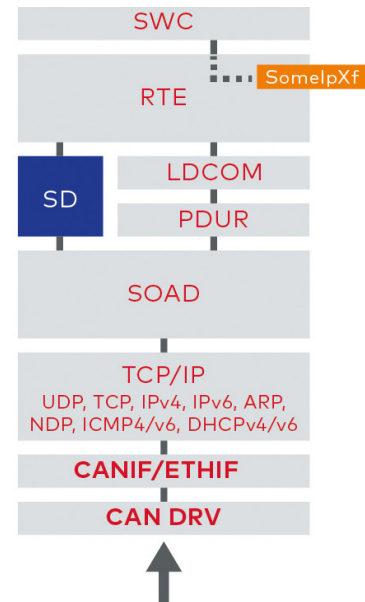

Figure 2: Stack for embedded Ethernet communication via CAN XL (Source: Vector Informatik)

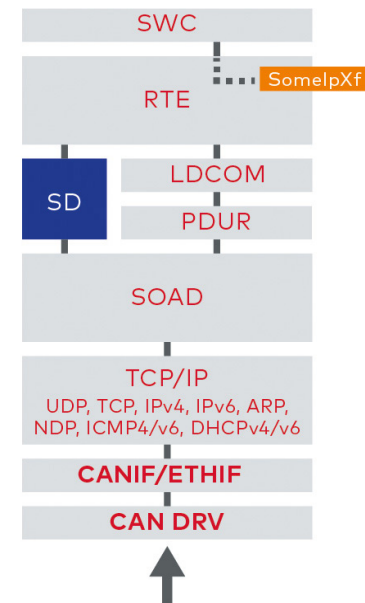

Figure 3: Stack for embedded IP communication via CAN XL (Source: Vector Informatik)

Ethernet part unpacks the IP frame. In addition, each CAN XL node requires a virtual MAC address. The CAN XL PHY then just requires one CAN frame for further transmission of the frames received by the Ethernet network to CAN XL, and for every CAN XL node to have another CAN frame for response data. Filter functions can be performed on the basis of the MAC address embedded in the frame. Under these conditions, Some/IP, Some/IP-SD, and ARP function exactly as in a pure Ethernet network (figure 2)

Routing IP frames

A second possibility is to use a suitable gateway and to route IP frames instead of Ethernet frames to CAN XL. The task ▶

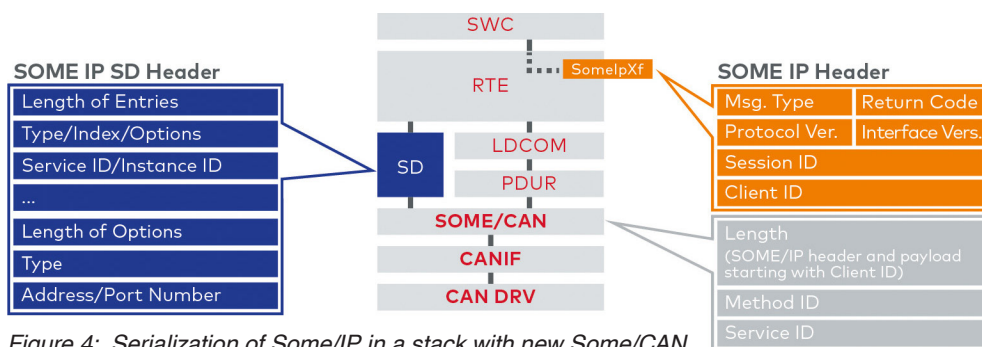

Figure 4: Serialization of Some/IP in a stack with new Some/CAN module (Source: Vector Informatik)

of the gateway is to unpack the IP frame from the Ethernet frame. With the aid of a suitable routing table in the gateway, the gateway recognizes the embedded IP address as a packet to be packed in a CAN XL frame and routed to the CAN XL network. Here too, a TCP/IP stack is needed by the CAN XL ECU. For the CAN interface, only minor changes are needed in the implementation, but major changes can be expected in the TCP/IP stack. The IP address embedded in the frame can be used for filtering. In this scenario as well, Some/IP and Some/IP-SD function exactly as in a pure Ethernet network (figure 3).

From the first two possibilities presented, we can conclude: Some/IP functionality can be achieved in both cases. Routing of Ethernet frames requires a new CAN PHY at the standard switch, while a new intermediate layer is necessary for the software stack on the CAN XL ECUs. When routing IP frames, changes in the software stack are also needed. Logic changes are not needed in the software modules; only the implementation needs to be modified. Hardware filtering would be useful in both cases, but would be resource-intensive.

A third possible solution is to dispense completely with the TCP/IP stack. The motivation for this is that about 50 KiB to 100 KiB of ROM storage capacity can be saved in each CAN XL ECU, enabling smaller and lower-cost controllers to be used. Here, a newly introduced "Some/CAN" layer replaces the TCP/IP (TCPIP) and Socket Adaptor (Soad) modules in the software stack. The Some/CAN layer is a suggestion by the authors and would need to be specified and implemented in greater detail if there is market interest. Routing and the conversion of Some/IP into Some/CAN takes place in the gateway. Some/IP messages are converted in the PDU (protocol data unit) router module. Some/IP-SD messages need to be deserialized in the application, then to be serialized back into corresponding Some/CAN frames. In doing so, the gateway replaces the IP address and the port number in the Some/IP-SD header, for instance, with a CAN ID, and identifies the frame as "CAN XL type". A CAN XL frame now transports an embedded, modified Some/IP frame, which consequently should be designated a "Some/CAN frames". While in Ethernet Some/IP subscribers listen to a dedicated (UDP) port, Some/CAN subscribers wait for special Some/CAN IDs. Whether Some/CAN frames or service discovery is involved, is indicated in the header by the message value. The message value FFFF 8100_h identifies a service discovery message (figure 4).

Some/IP communication can be transformed into CAN without a TCP/IP stack as shown. This makes Some/

CAN feasible, although this does depend on certain software modules in an appropriately expanded Autosar stack. Filtering via hardware is therefore excluded.

If the Some/CAN approach were adequately developed further, hardware filtering could still be practicable. To this

end, each user would receive a node address. This node address then enables hardware filtering. In this regard, it is also necessary to provide multicast or broadcast addresses for the service offering. Since node addresses are now used for addressing, the gateway must map them statically. For dynamic mapping, an appropriate address resolution solution for CAN node addresses needs to be implemented. A node address separates filtering and network access. This means that the priority can be changed without having to make a change to a user.

Outlook

This article sets out several options for implementing service-oriented communication with CAN XL. While the routing of Ethernet frames and IP frames can be envisaged, there needs to be a good way to filter hardware in order to be efficient. To implement smaller and more cost-effective controllers, it would be advisable to implement Some/IP communication by dispensing with a TCP/IP stack on CAN XL. The problem of early hardware filtering can be remedied by introducing a node address to avoid interrupt loads. The details of the direction in which service-oriented communication on CAN XL may yet develop are still unclear. The fact that service orientation on CAN XL is needed is demonstrated by the applications that are to be implemented. In overall terms, CAN XL is well equipped for this.

On page 28 ([Change in automotive communication systems](#)), the authors take a look on the transformational change of communication systems. CAN XL provides the basis for cooperation between IP technology and signal-based communication. It closes the gap between CAN FD and Ethernet. ◀

Authors



Oliver Garnatz, Peter Decker
Vector Informatik
info@vector.com
www.vector.com

This article originally appeared
in Hanser Automotive in
German language.

Data is the new oil

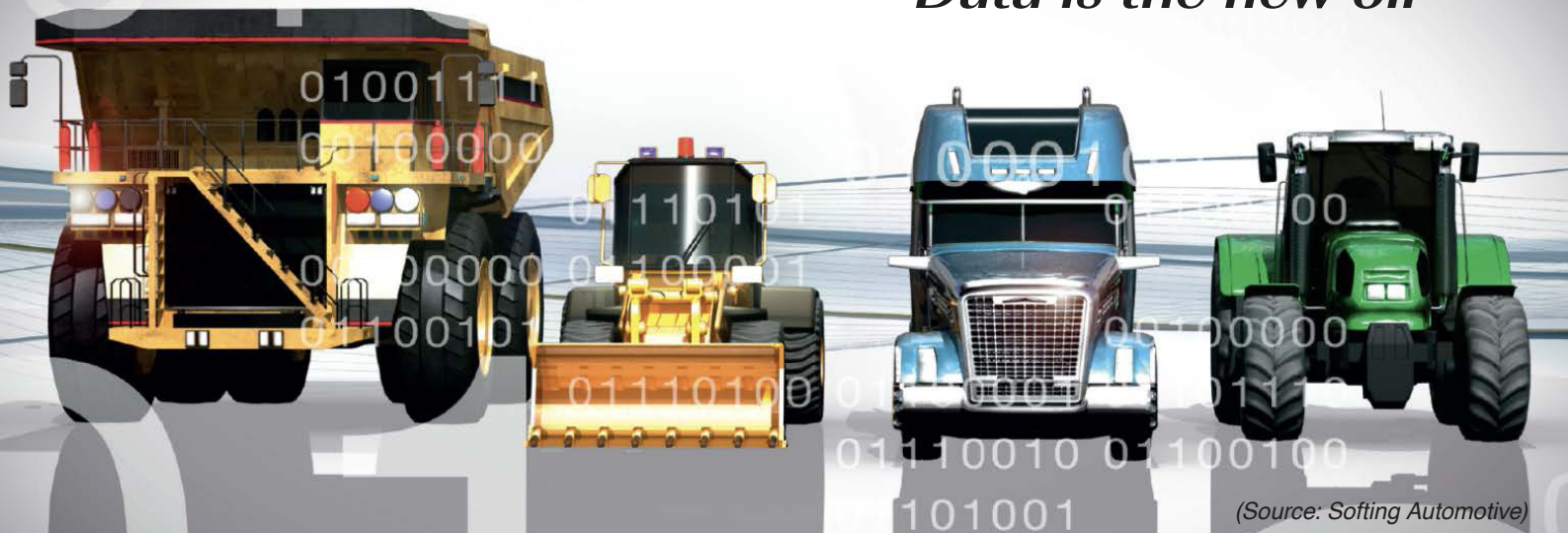

(Source: Softing Automotive)

Fleet managers expect error-free inspection, maintenance, and repair. For many businesses, an inspection and maintenance (I/M) process that meets the requirement “right at the first time” and serves the reduction of expensive downtime to a minimum is existential.

Be it a passenger car, a heavy-duty truck or a non-road mobile machine (figure 1), preventive maintenance (PM) is an important measure to reduce unexpected breakdowns. PM is a scheduled process, performed at regular service intervals. It includes but is not limited to inspection, cleaning, and lubrication, but also the exchange of fluids, filters, spark plugs, and drive/timing belts.

Predictive maintenance is similar to preventive maintenance and performed only when necessary. It consists of measures such as the exchange of a component that still functions but became conspicuous, because specific parameters indicate that a failure is about to occur, for example a bearing that started making noise.

Predictive maintenance is associated with condition monitoring and performed by the service technician only when needed – but how is the need discovered? It’s all about data - data is the new oil.

This term is credited to the British Mathematician Clive Humby and leads to the question, what data and oil have to do with each other. The simple answer is that both have no value in their raw state.

- ◆ Crude oil or petroleum has no value unless it is extracted and refined, e.g. to gas or plastics or other chemical products.
- ◆ Data has no value unless it is acquired, stored, decomposed, analyzed, converted, and processed. Figure 2 shows a simplified example of a data processing system.

Data processing

In the context of predictive maintenance, the vehicle is one of the most important data sources. Today’s vehicles and mobile machines are packed with E/E components. Figure 3 shows a representation of an E/E system and its most important components. Electronic control units (ECUs) such as the engine control module (ECM) and the transmission control module (TCM) are connected to each other by an in-vehicle network, typically CAN.

The gateway separates the in-vehicle network (and thus the in-vehicle data exchange) and the diagnostic link connector (DLC). ECUs process self-diagnostic functions, ▶

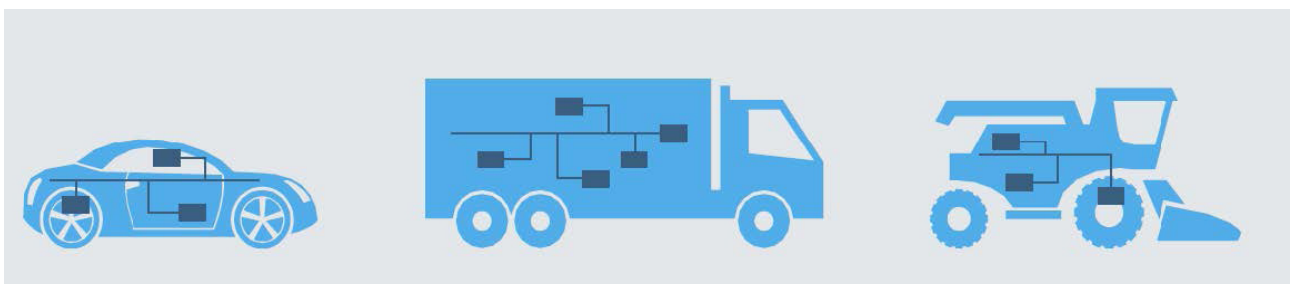

Figure 1: Road-vehicles and non-road mobile machines (Source: Softing Automotive)

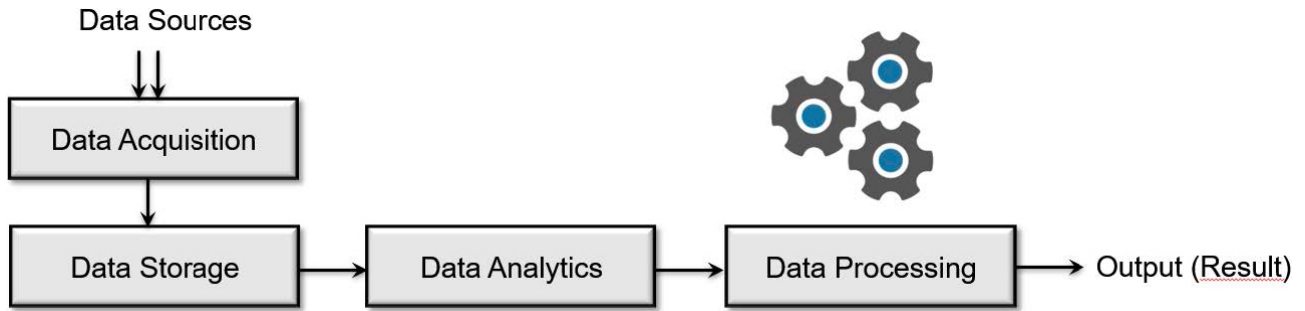

Figure 2: A simplified example of a data processing system (Source: Softing Automotive)

monitor their environment, and generate diagnostic data. Common examples of diagnostic data are diagnostic trouble codes (DTCs) and their associated freeze frames, and the DM1 message in a J1939 network.

For the purpose of I/M, road-vehicles are usually driven to a service workshop. Figure 4 shows the setup of a service workshop. A workshop tester (TST) is connected to the DLC of the E/E system. In this most common setup, a vehicle communication interface (VCI) is used for that purpose. The TST-to-VCI connection can be wired (USB) or wireless (Wi-Fi). The VCI-to-DLC connection is always wired and either CAN or Ethernet. K-Line and SAE J1850 are outdated.

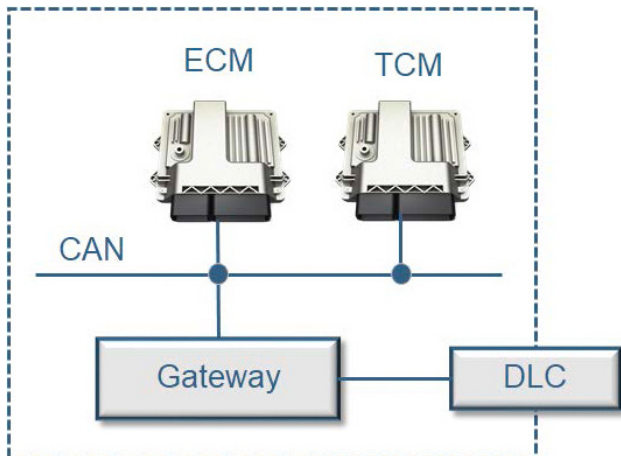

Figure 3: Representation of an E/E system (Source: Softing Automotive)

The workshop tester supports the service technician in the diagnostic process and the necessary I/M measures, for example by guided fault finding sequences. To acquire diagnostic data, the tester sends a diagnostic service

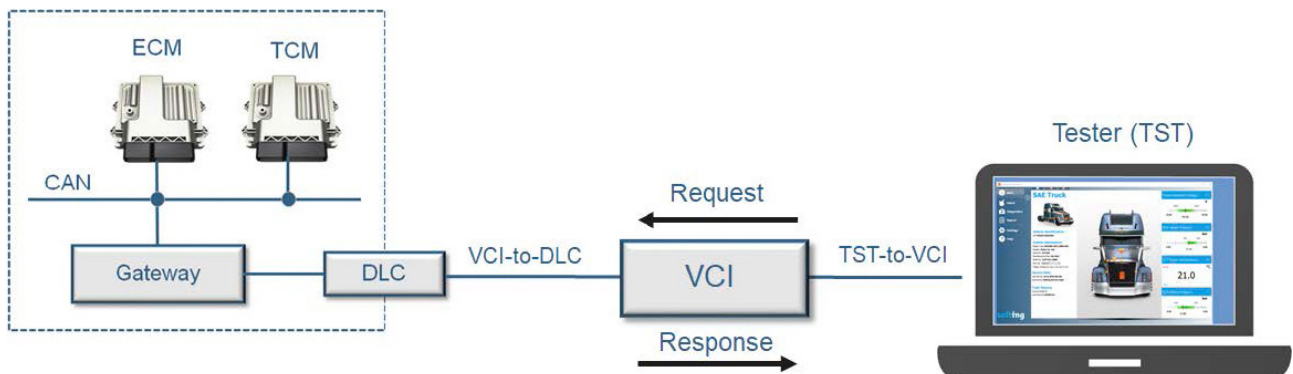

Figure 4: Setup of a service workshop (Source: Softing Automotive)

request and receives the associated diagnostic services response from the vehicle's E/E system. Requests and responses are standardized as diagnostic protocols such as OBD, SAE J1939, and UDS (Unified Diagnostic Services) on CAN or IP/Ethernet (ISO 14229).

A very common request is known as "mode 1" requesting the current powertrain diagnostic data from the OBD (on-board diagnose) system of the vehicle. Another common service is the ISO 14229 (UDS) request "read data by Identifier" with a 2-byte data identifier (DID) for the acquisition of theoretically more than 65 000 different values.

Table 1 shows the OBD and UDS services for data acquisition.

Inspection and maintenance in the service workshop is carried out when the vehicle speed is zero. To process condition monitoring under real driving conditions, the vehicle must be equipped with a data-logging device that is connected to the in-vehicle system and becomes part of the E/E-system. Figure 5 shows such a device and figure 6 the upgraded drawing of the E/E-system.

Extended telematics control unit

The extended telematics control unit (xTCU) has two CAN channels. One can be connected to the DLC, the other one to the powertrain CAN. The xTCU reads raw CAN signals and supports diagnostic protocols to request diagnostic data at the same time. In addition, the product comes with internal sensors for the position (GNSS), the acceleration, and the rotation (gyroscope) of the vehicle.

Most of the CAN signals are original equipment manufacturer (OEM) specific and confidential. Some of the sent signals can be used for predictive maintenance measures, but it is up the OEM to enhance their in-vehicle

Table 01: OBD and UDS services for data acquisition and their service identifier (SID)

SID	Diagnostic data
01 _h	Current powertrain diagnostic data
02 _h	Powertrain freeze frame data
03 _h	Emission-related DTCs
06 _h	On-Board monitoring test results
07 _h	Emission-related DTCs detected during current or last completed driving cycle
09 _h	Vehicle information (VIT)
0A _h	Emission-Related DTCs with permanent status
19 _h	DTC information
22 _h	Data by identifier
24 _h	Scaling data by identifier
2A _h	Data by periodic identifier

communication system with CAN signals that better support condition monitoring and predictive maintenance. The xTCU comes with an integrated 4G/LTE modem that connects the vehicle with a mobile network base station. CAN signals, diagnostic data, and inertia data are acquired under real driving conditions, enhanced with an e-SIM based identifier and sent periodically as MQTT packages to the data processing system in the cloud. The security of the communication link between CAN and cloud is patented.



Figure 5: The extended telematics control unit xTCU (Source: Globalmatix AG)

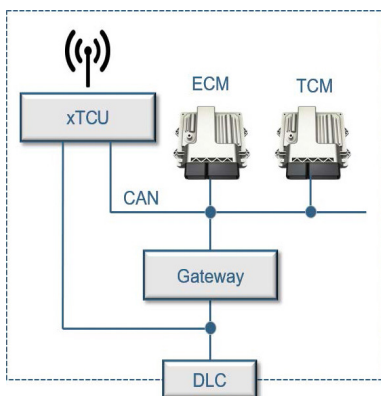

Figure 6: E/E system with xTCU (Source: Softing Automotive)

The quality of condition monitoring and predicted maintenance depends on the amount of data and its smart, targeted analysis. Installed in (multi-brand) vehicle fleets, the xTCU not only enables the OEM or the fleet manager to monitor the health status of their vehicles but to

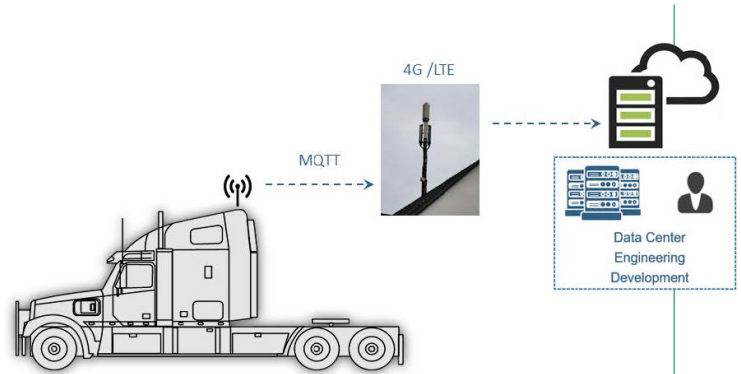

Figure 7: Cloud-based data acquisition system (Source: Softing Automotive)

extract information for predictive maintenance measures. The combination of real-time fleet data with diagnostic data collected in the workshops also enables the service organization to predict failures before they occur and thus increase the quality of the I/M process – right at the first time.

Author

Peter Subke
Softing Automotive
info@softing.com
www.softing.com





CAN in Automation

The non-profit CiA organization promotes CAN and CAN FD, develops CAN FD recommendations and CANopen specifications, and supports other CAN-based higher-layer protocols such as J1939-based approaches.

Join the community!

- ▶ Initiate and influence CiA specifications
- ▶ Get credits on CiA training and education events
- ▶ Download CiA specifications, already in work draft status
- ▶ Get credits on CiA publications
- ▶ Receive the exclusive, monthly CiA Member News (CMN) email service
- ▶ Get CANopen vendor-IDs free-of-charge
- ▶ Participate in plugfests and workshops
- ▶ Get the classic CANopen conformance test tool
- ▶ Participate in joint marketing activities
- ▶ Develop partnerships with other CiA members
- ▶ Get credits on CiA testing services

*For more details please contact CiA office
at headquarters@can-cia.org*

www.can-cia.org