

June 2022

# CAN Newsletter

*Hardware + Software + Tools + Engineering*



*From classic CANopen to CANopen FD*

*CiA members from the beginning*

*CAN goes on (and under) the sea*

*CAN in air and space*

*History and trends*

[www.can-newsletter.org](http://www.can-newsletter.org)

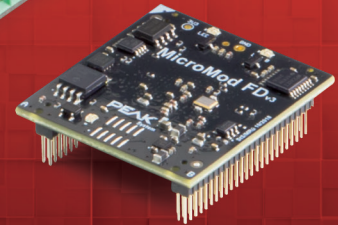
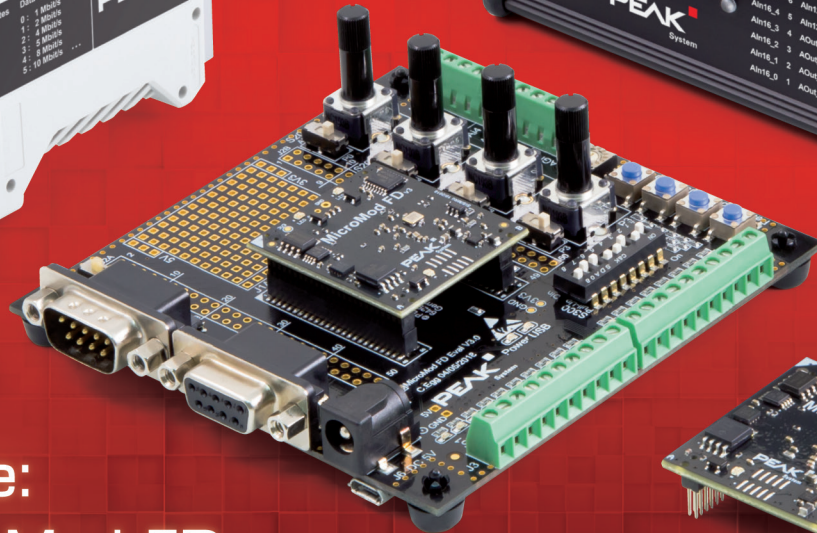

## Product Line: PCAN-MicroMod FD

### ■ I/O Modules with CAN FD & CANopen FD

The PCAN-MicroMod FD is a plug-in board that provides a CAN FD interface and I/O functionality for the integration into your hardware. An evaluation board facilitates developing your custom solution. The modules are configured with a Windows software via CAN and then operate independently.

#### Ready-to-Use Motherboards

The PCAN-MicroMod FD is available with motherboards providing peripherals for specific applications.

#### Common Features:

- Board with plugged on PCAN-MicroMod FD
- CAN FD connection with switchable CAN termination
- 2 frequency outputs (Low-side switches, adjustable range)
- Analog input for voltage monitoring up to 30 V (12 bit)
- Aluminum casing with spring terminal connectors
- Extended operating temperature range from -40 to 85 °C
- Operating voltage 8 to 30 V

#### PCAN-MicroMod FD Analog 1:

- 8 analog inputs (16 bit, adjustable range)
- 4 analog inputs (12 bit, 0 - 10 V)
- 4 analog outputs (12 bit, adjustable range)
- 4 digital inputs (pull-up or pull-down)

#### PCAN-MicroMod FD Digital 1 / Digital 2:

- 8 digital inputs (pull-up or pull-down)
- 3 analog inputs (12 bit, 0 - 10 V)
- Digital 1: 8 digital outputs with Low-side switches
- Digital 2: 8 digital outputs with High-side switches

#### CANopen & CANopen FD Solutions

The PCAN-MicroMod FD DR CANopen Digital 1 is an I/O module for operation in CANopen (FD)<sup>®</sup> networks.

#### Main Features:

- CANopen<sup>®</sup> and CANopen FD<sup>®</sup> connection
  - Communication profiles according to CiA<sup>®</sup> 301 version 4.2.0 and CiA<sup>®</sup> 1301 version 1.0.0
  - Device profile according to CiA<sup>®</sup> 401 version 3.0.0
  - Certified CANopen<sup>®</sup> and CANopen FD<sup>®</sup> conformity
- 8 digital inputs, comply with the IEC 61131-2 standard
- 8 digital outputs with High-side switches
- Plastic casing (width: 22.5 mm) for mounting on a DIN rail

All PCAN-MicroMod FD products can alternatively be operated with CANopen<sup>®</sup> and CANopen FD<sup>®</sup> firmware from our partner Embedded Systems Academy.



## History and trends

From classic CANopen to CANopen FD	4
CiA members from the beginning	7
CAN goes on (and under) the sea	12
CAN in air and space	18

## Imprint

### Publishing house

CAN in Automation GmbH  
 Kontumazgarten 3  
 DE-90429 Nuremberg  
[publications@can-cia.org](mailto:publications@can-cia.org)  
[www.can-cia.org](http://www.can-cia.org)  
 Tel.: +49-911-928819-0  
 Fax: +49-911-928819-79  
 Reiner Zitzmann (CEO)  
 VAT-ID: DE812852184  
 HRB: AG Nürnberg 24338

### Publisher

CAN in Automation e. V.  
 Kontumazgarten 3  
 DE-90429 Nuremberg  
 VAT-ID: DE169332292  
 VR: AG Nürnberg 200497

### Editors

Olga Fischer (of)  
 Cindy Weissmueller (cw)  
 (responsible according to the press law)  
 Holger Zeltwanger (hz)  
[pr@can-cia.org](mailto:pr@can-cia.org)

### Layout

Nickel Plankermann

### Media consultants

Tobias Kammerer  
 Birgit Ruedel (responsible according to the press law)  
 Rozanna Rybin  
[publications@can-cia.org](mailto:publications@can-cia.org)

### Downloads March issue

(retrieved May 22, 2022)  
 5530 full magazine

### © Copyright

CAN in Automation GmbH

The views expressed on CAN Newsletter magazine are not necessarily those of CiA e. V. While every effort is made to achieve total accuracy, neither CiA e. V. nor CiA GmbH can be held responsible for any errors or omissions.



## Applications

Feeding cows in the 21 <sup>st</sup> century	26
Extending the CAN network	34



## Engineering

Open-source CANopen protocol stack extended	8
One solution for complex CAN architectures	28



## Testing

ISO 14229 UDS protocol: Automotive diagnostics	24
Measurement and calibration tool	38



## Brief news

Standards and specifications	22
------------------------------	----

## 30 years of CAN Newsletter: From hardcopy to PDF format

The first issue of the quarterly-published CAN Newsletter was released in June 1992. It counted 16 pages with brief news about CAN products and the CAN in Automation (CiA) user organization established in March 1992. The first issue was written in German language. From the March issue 1994 on, the hardcopy Newsletter was published in English language. Increasingly, it provided technical in-depth articles, reports about applications, and detailed background information.



In 2014, CiA stopped printing the CAN Newsletter on paper. Since this time, the magazine is available in [PDF format as download](#) only. The access is free of charge. The March 2022 issue was downloaded about 5530 times. In addition, 15 879 articles of this issue were downloaded individually (retrieved May 22, 2022).

In total, 120 issues of the CAN Newsletter were published. The content is very sustainable. The issues and articles are downloaded even after years of publication. Editor-in-chief was from the beginning Holger Zeltwanger (who was also initiator of CAN in Automation). In 2022, with this issue, Cindy Weissmueller took over the responsibility for the content of the CAN Newsletter. She is in the editing team since 2013.

## History and trends:

# From classic CANopen to CANopen FD

*The CANopen application layer was developed under the umbrella of a European research project. In the last three decades, it has penetrated many application fields. CAN in Automation (CiA) has released more than 20 000 pages of CANopen profile specifications.*

The predecessor of CANopen, was the CAN Application Layer (CAL) specified by CiA members in 1992. Because the CAL specifications were very academic based on the OSI reference model, the ASPIC (Automation and Control System for Production Units and using an Installation Bus Concept) European research project was launched. Bosch led it and mayor contribution came from the University Newcastle (UK). The project participants introduced dedicated application layer protocols and a communication profile. This included the CANopen dictionary with a 16-bit index and an 8-bit sub-index addressing method for parameters. The communication parameters were assigned to the index range from 1000<sub>h</sub> to 1FFF<sub>h</sub>. In the range 6000<sub>h</sub> to 9FFF<sub>h</sub>, process data, application configuration, and diagnostic information of standardized profiles are available. Proprietary application parameters use the index range from 2000<sub>h</sub> to 5FFF<sub>h</sub>. The research results, about 30 pages, were handed over to CiA for further development and maintenance.

### The history: Classic CANopen

End of 1994, CiA released the first version of the CANopen application layer and communication profile, which was updated just two months later. Version 2.0 was the base for the first CANopen demonstrator exhibited on the Hanover Fair CiA booth in 1995. In the beginning, the name "CANopen" and the document number "CiA 301" were not used. But from version 3.0, this CAN-based application layer and communication profile was published in the CiA 301 document. This version was implemented in the first commercially available CANopen devices. In the beginning, IEC 61131-compliant programmable logic controllers (PLC) were rare. CANopen host controllers were mainly embedded control devices programmable in computer languages such as C and C++. But actuator and sensor manufacturers provided increasingly CANopen interfaces for their products. Embedded host controllers not fully compliant with CiA 301 were able to control and manage these CANopen products. Many of them did not provide an object dictionary. The disadvantage: They could not be diagnosed via the CAN network.

Of course, there were some misunderstandings of the CiA 301 specification. Many engineers thought and some still do it today that the pre-defined connection set of

**CANopen**<sup>®</sup>

CAN identifiers comprising a 4-bit function code and a 7-bit node-ID have to be

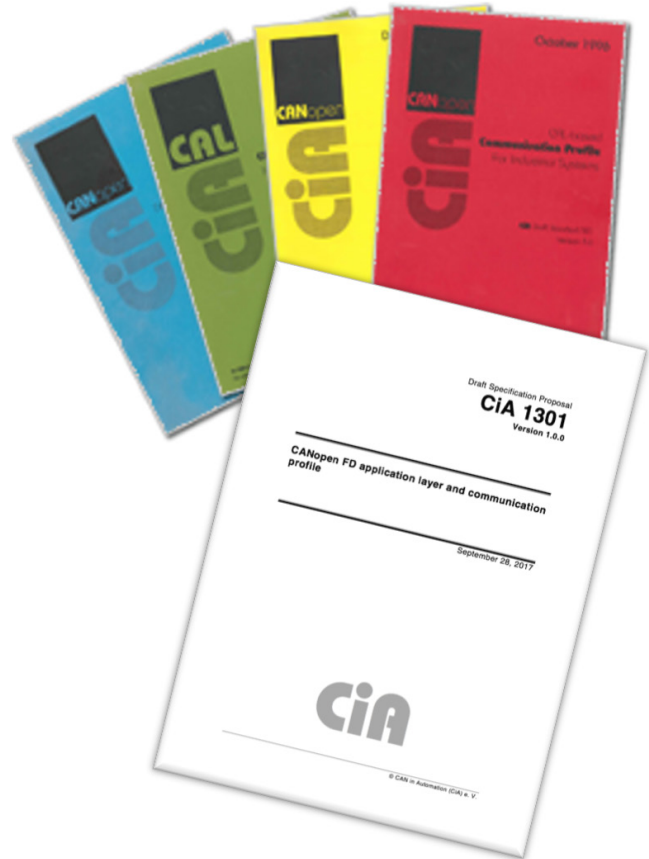

Figure 1: CAN in Automation has released more than 20 000 pages of CANopen profile specifications (Source: CiA)

used. The truth is that only the Default SDO client message, the Heartbeat messages, and the NMT message have fixed function codes. All other CANopen messages can be configured with all not restricted 11-bit CAN identifier values. Details are given in CiA 301.

Another misinterpretation is that the SYNC and the TIME messages need to be send by the CANopen host controller. Correct is that any CANopen device can do it. The system designer has to take care that there is a consistent assignment of the producing and consuming CANopen devices. There are also misunderstandings caused by not often implemented features. A feature could be specified, but nobody has implemented it. This does not mean that this feature is not provided by CANopen.

Some people think that CANopen is complex. But it is not. It is more complex to specify all the CANopen functions by yourself. CANopen specifications are like menus: You need to order and eat only what you like. You don't have to take all offered meals. ▶

From CANopen version 4.0 onwards, four PDOs to be transmitted and four PDOs to be received can be assigned with a pre-defined CAN identifier. This version also introduced the Boot-up message using the same fixed (not configurable) CAN-ID as the Heartbeat message. In version 3.0, some device manufacturers misused the EMCY message as a boot-up indication.

CiA does not recommend to use CAN remote frames at all. Therefore, NMT node-guarding and remotely requested PDOs are not longer state of the art. It is also not recommended to change the bit-timing parameters and the node-ID number by means of SDO services in the CANopen object dictionary, because this could lead to severe network problems. If you like to configure them via the CANopen interface, layer setting services (LSS) should be used as specified in CiA 305.

### The success: Profile specifications

The first CANopen device profile released specified the process data and configuration parameters for input/output (I/O) modules. This specification is known as CiA 401 and covers digital and analog I/Os. Besides this very generic profile, CiA members developed the CiA 402 profile for (electrical) drives and motion controllers. This was and is one of the most successful CiA profile specifications. In the meantime, it is internationally standardized in the IEC 61800-7 series. It has been adapted also by other communication technologies, especially Ethercat. There

are also profiles for encoders (CiA 406) and inclinometers (CiA 410), which are used in very different applications fields. They range from textile machines via pitch control in wind-power systems and medical scanner devices to cranes and construction machines – just to name some of the important ones (see insert “CANopen application stories”).

CiA has specified also application-oriented profiles. The CiA 417 series, for example, specifies elevator control systems. The CiA 422 series internationally standardized in EN 16815 describes the CANopen interfaces for refuse collecting vehicle equipment. There are still some unused treasures in the CiA profile portfolio. In total, the CiA profile specifications comprise more than 20000 pages. There are also profiles developed jointly or even outside of the CiA community. The CiA 420 series of profiles for extruder downstream devices has been published with nonprofit Euromap association for plastics and rubber machinery manufacturers. DIN has released the DIN 14700 series of CANopen-connectable fire-fighting equipment. This German standard is under review and will be published in English language. Another jointly developed profile family is CiA 454: Together with Energybus members, these documents have been submitted partly for IEC standardization. The IEC standards specify the charging of light electric vehicles (LEV) in public infrastructures. The CiA 454 profile covers additional power management devices, too. ▶

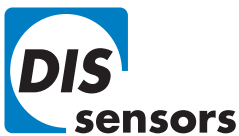

# Dynamic inclinometer

## AVAILABLE NOW

Stable real-time measurement,  
even during rapid movement

- Gyro-compensated
- Based on MEMS technology
- Measuring range: 1 axis up to 0 - 360°, 2 axes up to ± 90°
- CANopen or J1939 interface (data and configuration)
- User-friendly configuration tool
- Advanced hardware and software technology
- Compact, robust housing



The CiA profile specifications are also mappable to other communication technologies. Therefore, CiA split its updated and reviewed profile specifications into an application layer independent part describing only the application parameters. The mapping to the CANopen and the CANopen FD application layers is provided in separate documents. This includes also the requirements on the communication parameters.

CiA has also mapped its encoder and inclinometer profiles to J1939. In future, other CiA profiles may also be mapped to the J1939 application layers depending on market requests.

## The future: CANopen FD

Classic CANopen is limited by the Classical CAN data link layer and the CAN high-speed physical layer regarding the network throughput. This is caused by the maximum bit rate at a given network length and the 8-byte data field limit requiring a transport layer protocol for larger data, which needs some protocol overhead. To overcome these limitations, the CAN community has developed the CAN FD data link layer (ISO 11898-1:2015) and the CAN SIC transceiver specification (CiA 601-4). CiA members have also improved CANopen, in order to use the new features of CAN FD, especially the longer data field with up to 64 byte. CANopen FD (CiA 1301) provides also an extended Universal SDO functionality, which allows to use pre-defined USDO clients in every device. This means USDO communication is possible between all connected CANopen FD devices.



CANopen FD protocol stacks are available from different vendors (Emotas, Emsa, and Microcontrol). Microcontrol and Peak provide very first CANopen FD products: host controllers and I/O devices. Most of the earlier adopters use CANopen FD as embedded networks and not as open network solution. They regard this is a secret and do not provide public information about such first CANopen FD applications.

CANopen FD can also be mapped to CAN XL, the currently submitted third CAN protocol generation for ISO standardization. An SDT (service data unit type) value needs to be assigned. The 8-bit SDT is the next implemented higher OSI layer indication embedded in the CAN XL data link layer protocol. In conjunction with 8-bit VCID (virtual CAN network ID), you can run up to 256 CANopen FD applications in parallel on a single network segment. Of course, you can also use on the same cable J1939-22 applications indicated by another SDT value. This allows the usage of CAN XL as a backbone network in applications, in which different higher-layer protocols are used. This includes also TCP/IP solutions.

To map CANopen FD to CAN XL requires additionally an assignment of communication services to the 32-bit acceptance field and how to use the 11-bit priority identifier. This is in the scope of the CiA IG (interest group) CANopen

## CANopen application stories

The list of CANopen application examples is very long. In the last three decades, CANopen has been used as embedded control network, in machines on wheels, in elevators, in medical and laboratory equipment, in rail vehicles, and in maritime electronics, for example. The most exotic applications include embedded networks on the ocean ground and in satellites. The CAN Newsletter has reported about some of them:

- ◆ [Textile industry: Haircut with a hot flame](#)
- ◆ [Traffic light: Panel PC with four CANopen interfaces](#)
- ◆ [Silicon wafer production: Multi-axis system for solar industry](#)
- ◆ [Healthcare: Tumor treatment with a CANopen motor](#)
- ◆ [Farming: Milking robot](#)
- ◆ [Beverage production: Filtration process for improved drinks](#)
- ◆ [Construction machines: Automatic leveling system for graders](#)
- ◆ [Satellite: CAN in the outer space](#)
- ◆ [Maritime electronics: Sensors for ship cranes](#)
- ◆ [Commercial vehicles: Battery charger for on-board integration](#)
- ◆ [Elevator control: Hydraulic car drive](#)
- ◆ [Municipal vehicles: Automated sewer cleaning with CANopen](#)

Classic CANopen is still used in many new network applications. The provided communication services are sufficient for many embedded networks. 'CANopen' and 'CANopen FD' are European Community trademarks by CAN in Automation.

FD and will be introduced in one of the next versions of the CiA 1301 specification.

Because CAN XL hardware such as protocol controllers and transceivers compliant with CiA 610-1 respectively CiA 610-3 is not yet available, there is no hurry to release the CAN XL extension for CANopen FD. First micro-controllers supporting CAN XL will be launched mid of the 20ies. CAN SIC XL transceivers are expected a little bit earlier. Prototypes have been tested already in the first [CAN XL plugfest](#) organized by CiA in summer 2021 as well as FPGA implementations of CAN XL protocol controllers. [Another plugfest took place in May, 2022.](#) ◀



Author

Holger Zeltwanger  
CAN Newsletter  
[pr@can-cia.org](mailto:pr@can-cia.org)  
[www.can-newsletter.org](http://www.can-newsletter.org)

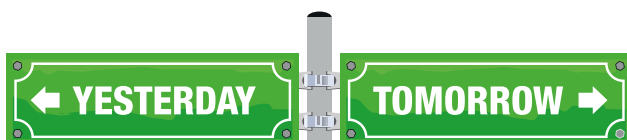

# CiA members from the beginning

There are 14 members who joined the non-profit CAN in Automation (CiA) association in 1992 and are still members. Today, the CAN users' and manufacturers' group counts more than 720 members.

(Source: Adobe Stock)

Besides two founding members, ESD Electronics and G.i.N., some more companies have joined CiA 30 years ago. These are in alphabetic order: Eckelmann, Janz Tec, KEB Automation, Kvaser, Moba Mobile Automation, Moog, NXP (formerly Philips Semiconductors), Port Industrial Automation, Selectron Systems, Softing, and Vector Informatik. Most of them are German companies. Kvaser from Sweden, Philips Semiconductor headquartered in the Netherlands, and the Swiss Selectron were exceptions. There is one member not listed yet: Holger Zeltwanger, the initiator of the association. He was a private individual working in those days as an editor for the German VMEbus magazine.

Holger Zeltwanger said: "Kvaser was a very early CAN admirer. The company developed already before the CiA foundation CAN solutions for the textile industry and supported manufacturers of hydraulic devices with CAN connectivity. Philips Semiconductor provided the 80C200 stand-alone CAN controller competing against the 82526 stand-alone controller by Intel (USA). The Dutch chipmaker was also one of the first companies offering an integrated CAN high-speed transceiver. The company, now part of NXP, is today still a known CAN transceiver supplier. The first transceiver chips coming directly from the factory were given to CiA members to apply them in their products. These were connected in the very first CiA plugfest on the Interkama tradeshow in October 1992. "This was the first demonstration of CAN-interoperable products", he continued.

Talking to Holger Zeltwanger, he explained more details: "The early German CiA members provided different CAN-connectable devices. G.i.N produced some tiny CAN I/O modules, while ESD manufactured CAN interface modules besides VMEbus board-level products. A similar portfolio was provided by Janz Tec. KEB and Moog were suppliers of electrical respectively hydraulic actuators. Eckelmann developed decentralized control systems on behalf of machine builders as well as Selectron. Both companies offered host controllers and I/O modules. In the meantime, Selectron has changed its focus to rail vehicle control devices – still implementing in many of its products CAN interfaces. Softing, headquartered

in Haar (near Munich), develops and manufactures CAN-capable hardware and software for industrial automation and vehicle electronics. Port was the first East German company joining the CiA. Moba offering electronic devices for construction machines was another enthusiast of CAN technology. Vector Informatik started its CAN business with one of the first CAN analyzing tools and became also a CiA member in 1992".

Without these fourteen members, the CiA association would not have been developed as it happened. These CiA pioneers organized jointly the first CAN plugfest in October 1992 and developed already in May 1992 the first CiA specification, which demanded the use of high-speed transceivers and recommended a pin-assignment for the 9-pin (DIN) Dsub connector.

Of course, there are also other important CiA pioneers, which nowadays are no members anymore, but have contributed to the development of the CiA association, said Zeltwanger. "For example, the STZP technology transfer center and Philips Medical Systems (now: Philips Healthcare) were the main contributor to the CAN Application Layer (CAL). The first CAL work drafts saw the light of day already in the second of half of 1992. STZP became Ixxat, which was acquired by HMS Networks (Sweden). Philips Medical Systems is now Philips Healthcare and left CiA in 2019. The CAL specifications were released as CiA 200 series and were the base of the CANopen application layer and communication profile developed by a European research project". [But this is another story.](#)



On June 1 and June 2, CiA celebrates its 30<sup>th</sup> anniversary with an in-person event in Nuremberg (Germany)



Holger Zeltwanger, initiated the CiA association 1992 in Nuremberg (Germany)



## Author

Cindy Weissmueller  
CAN Newsletter  
[pr@can-cia.org](mailto:pr@can-cia.org)  
[www.can-newsletter.org](http://www.can-newsletter.org)

# Open-source CANopen protocol stack extended

*CANopennode is a free and open-source CANopen protocol stack available on Github. Recently, it was extended by a CANopen stack example running on STM32 micro-controllers.*



(Source: Adobe Stock)

**C**ANopennode is written in Ansi-C in an object-oriented way. It runs on different micro-controllers, as standalone application, or with RTOS (real-time operating system). Variables for CANopen network communication, for CANopen device control, or customer-defined functions are collected in the CANopen object dictionary. These variables are accessible from the C-code and from the CANopen network. The object dictionary editor tool is available. Non-volatile storage for object dictionary or other variables is possible. The software stack is suitable for 16-bit micro-controllers and above. The software is multi-threaded and real-time capable. Power saving and bootloader functions are enabled as well. Currently, the version 4 of the protocol stack is available.

## Available features

The provided CANopen object dictionary offers a clear and flexible organization of any variables. Variables can be accessed directly or via read/write functions. The NMT (network management) functionality enables to start, stop, and reset a CANopen device using the simple NMT manager functionality. To monitor the device's availability in the network, the heartbeat producer and consumer error control is included. PDO (process data object) function block can be used for broadcasting process data with high priority and no protocol overhead. Variables from

the object dictionary can be dynamically mapped into the TPDO (transmit PDO), which is then transmitted according to communication rules as specified in CiA 301 CANopen application layer and communication profile (EN 50325-4). This data is received as RPDO (receive PDO) by another device(s).

The SDO (service data object) server functionality, which has to be obligatory implemented in a CANopen device, enables expedited, segmented, and block transfer access to all object dictionary variables inside of this device. An SDO client can access any object dictionary variable on any CANopen device inside the CANopen network. A CANopen device can implement the emergency message producer function. Devices, which have to be informed on emerging failures, implement the emergency consumer function. The provided Sync producer/consumer enables network synchronized transmission, receipt, and processing of exchanged process data, etc. The time-stamp producer/consumer enables date and time synchronization of the networked devices.

In addition to the basic CANopen functionality as covered by CiA 301, the LSS (layer setting service) implementation is given to setup the device's node-ID and bit rate. The LSS server and LSS manager functions as well as the LSS fastscan service are part of the open-source protocol stack. To access CANopen via TCP, a CANopen gateway implementation according to CiA >



309-3 is given. This provides an Ascii command interface for NMT manager, LSS manager, and SDO client. For communication in safety-relevant networks, the CANopen Safety module was developed. The functional safety communication based on CANopen is specified in EN 50325-5 (former CiA 304).

The community providing the protocol stack claims that the implementation passed the CANopen conformance test using the [CANopen conformance test tool](#). The tool is used to verify that CANopen devices are compliant with the CiA 301.

## Protocol stack project modules

The CANopen protocol stack is the base for a CANopen device. It contains no device-specific code (drivers), which must be added separately for each target system. An example (CANopendemo) shows the basic principles, compiles on any system, but does not connect to any CAN hardware. CANopendemo includes a demo program, tutorial, and testing tools. It is based on CANopennode and is included as a git sub-module.

CANopeneditor is an external GUI (graphical user interface) tool for editing the CANopen object dictionary for a custom device. It generates the CANopennode C source-code files, electronic data sheet (EDS), and documentation for the device. The tool imports and exports the CANopen electronic data sheets in EDS or XDD (XML device description) format.

Complete generated documentation for CANopendemo, CANopennode, and other devices, is available online at <https://canopennode.github.io>. All codes are documented in the source header files. Some additional documents are provided in the doc(ument) directory. A tutorial and the possibility to [report issues](#) is given. The [older discussions](#) can be consulted on Sourceforge. The community welcomes contributions of further implementation examples.

## Device support

CANopenNode can run with or without operating system on many different devices (or micro-controllers). It is necessary to implement an own interface to the CANopennode on a specific hardware. Implementations with different development tools are possible. It is not practical to manage all device interfaces in a single project. Thus, interfaces to different micro-controllers are located in separate projects. There are interfaces to Linux SocketCAN, Zephyr RTOS, PIC, Mbed-os RTOS + STM32, NXP, etc. The [known device interfaces](#) are given in a list on the project's website. Most up-to-date implementations of CANopennode are CANopenlinux and CANopenPIC for PIC32 micro-controllers from Microchip.

## Extended by examples for STM32

Recently, the open-source CANopennode library was extended by [CANopenSTM32](#). The latter is a CANopen stack example running on STM32 micro-controllers from ▶

# Rugged CAN Solutions For The Real World

Engineered to meet the expectations of heavy industries, the Kvaser U100 is as well suited to CAN system design as it is to CAN system maintenance and repair.

Learn more: [www.kvaser.com/u100](http://www.kvaser.com/u100)



## STM32 and CANopen protocol stack provider

In July 2020, Emotas' CANopen protocol stack software has been endorsed by ST to become the first MadeForSTM32-approved CANopen software for STM32 micro-controllers. The MadeForSTM32 label is available for ST authorized partners only. It ensures that the software within the STM32 ecosystem had been reviewed and qualified by ST specialists. The protocol stack vendors Microcontrol, Port, and Simma are also taking part in ST's partner program.



*The MadeForSTM32 label is available for ST authorized partners only and ensures that the software had been reviewed and qualified by ST specialists (Source: ST Microelectronics)*

The CANopen software expansion includes the Emotas' CANopen stack basic functionality wrapped into an STM32Cube expansion package. The expansion simplifies the seamless integration into STM32Cube projects. The delivery includes the stack's Ansi-C source code and various ready-to-run examples. Besides a free evaluation package, commercial licenses of the product are available. The product is completed by the CANopen Devicedesigner tool that generates the object dictionary and device descriptions files (EDS). The CANopen expansion is currently available for the STM32G4 series. Support for additional STM32 series is planned.

Three months before, in April 2020, Port extended its CANopen driver portfolio by support of the STM32G4xx family. It can be used together with the company's CANopen protocol stacks covering the CANopen NMT (network management) manager and/ or CANopen NMT server functionality. For integration of the CANopen

library, the Industrial Communication Creator tool is available. It is suited for development of CANopen applications and programming of the CANopen devices. The tool also generates an object dictionary and an initialization function code in Ansi-C. An electronic data sheet and the documentation of the project are created as well. The tool is also used to configure the CANopen library and the CANopen driver packages.

Already in 2018, Emotas joined forces and partnered strategically with HMS Industrial Networks/Ixxat. The cooperation covers protocol stacks for CANopen and SAE J1939, tools, and CAN interface products. The partnership also includes the distribution of the CAN hardware products from HMS in combination with Emotas software tools. This means, at that point HMS/Ixxat has discontinued its own protocol stack developments.

The remaining German off-the-shelf suppliers include Embedded Office, EmSA (formerly Embedded Systems Academy), ESD Electronics, Micrium, Micro-control, Port, and SYS TEC. There are also some CANopen stack suppliers in other countries such as I.s.i.t. (France) and Simma Software (USA). Additionally, open-source projects (for example CANfestival and CANopennode) develop CANopen protocol software. Already a couple of years ago, Vector has had discontinued its CANopen stack business.



*The STM32G4 series is based on a 32-bit Arm Cortex-M4 core (Source: ST Microelectronics)*

ST Microelectronics (ST). It is developed in STM32cube IDE tool, which is the official ST development studio for any STM32 micro-controller. The user can directly open projects and run prepared examples on the board.



*Figure 1: STM32cube IDE tool is the official ST development studio for any STM32 micro-controller (Source: ST Microelectronics)*

The currently used development board is the STM32H735G-DK. It provides various features of the STM32H7xx series and includes three on-board CAN transceivers. Thus, no additional hardware to connect to existing CAN networks is required. It also includes a built-in programmer and a virtual COM (communication) port for evaluation purposes.

The CANopen demo works at the FDCAN1 port and is used for communication at 125 kbit/s. The FDCAN IP block is the same for any STM32H7xx MCU (micro-controller unit) family, hence migration to a custom board should be

straight-forward. CANopen LED control according to CiA 303-3 is integrated. Debug messages are available via the COM port. The examples can be used as a reference code for the end product. The existing projects can be cloned or updated. ◀

### Author

Olga Fischer  
CAN Newsletter  
[pr@can-cia.org](mailto:pr@can-cia.org)  
[www.can-newsletter.org](http://www.can-newsletter.org)



**High-end Connectivity and Data Management**

**Telematics and Cloud Systems for IoT and Service 4.0**

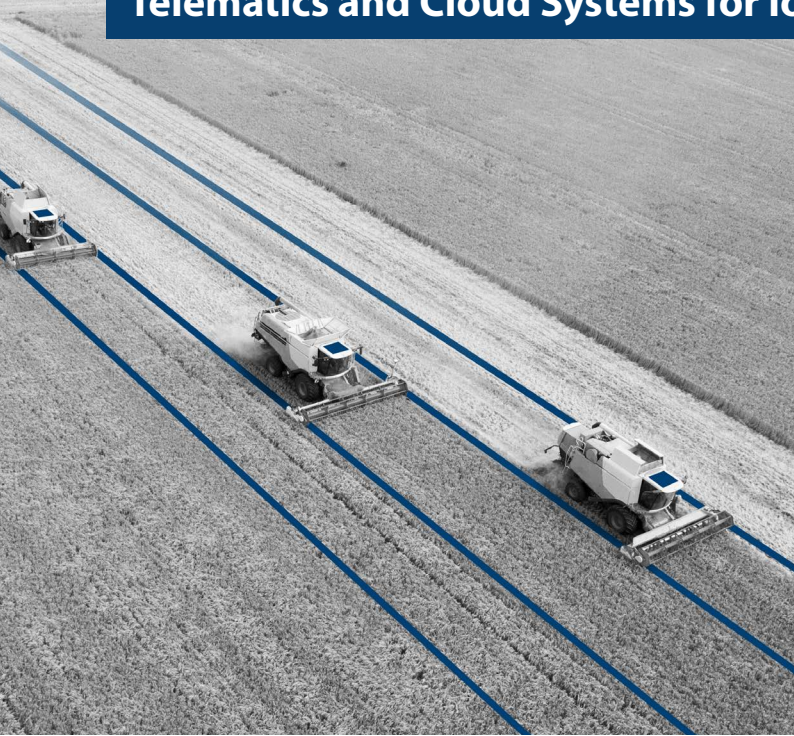

**Continuous digitization for smart vehicles**

Modular on-board units – from cost-saving entry telematics up to high-end modules. Including updates-over-the-air, embedded diagnostic functionality and up to 4x CAN channels (CAN FD ready).

Sontheim IoT Device Manager and IoT Analytics Manager – for a highly secure, comfortable and individual visualization as well as management of your data and fleet.

**COMhawk® xt – Telematic ECU Series**



Up to 4x CAN acc. to ISO 11898



LTE, WLAN, Bluetooth, LAN



Multi-protocol support (J1939, J2534, UDS, KWP, ...)



Positioning (GNSS)



Embedded diagnostic functionality



Integrated update-over-the-air functionality



*History and trends:*

## *CAN goes on (and under) the sea*

*CAN networks are used in maritime electronics since a long time. There are different standardized applications based on CANopen and J1939 (known as NMEA 2000). Currently, CiA started to specify a dual-mode redundancy concept suitable for all three CAN protocol generations.*



(Source: Adobe Stock)

Already, mid of the 90ties, MTU (Germany) reported on the 2<sup>nd</sup> international CAN Conference (iCC) in London about CAN networking in ship automation systems. Dr. Olaf Schnelle presented the MCS-5 decentralized automation system, which was on duty for about 20 years. In the meantime, it is substituted by the Ethernet-based MCS-6 monitoring and control system. In midterm, all MCS-5 systems will be converted to the MCS-6 controllers. MTU's engine control system (ECS) is still connected to the MCS-6 host controller by means of a CAN interface and discrete I/O lines. The CAN interface is redundant as required in marine applications.

Another early adopter of CAN networking in maritime electronics was Kongsberg (Norway). Jointly with Ixxat (now part of HMS networks, Sweden), the Norwegian company developed ship automation systems based on CANopen. Prof. Dr. Konrad Etschberger (Ixxat) presented it on the iCC 2000. This technical solution went into the CiA 307 specification for electronics in ships and vessels. In the meantime, the document was withdrawn. The significant parts of the CiA 307 document, especially the CANopen redundancy, has been moved into the CiA 302-6 document not more dedicated and limited to marine applications. A typical product, implementing the profile, is the segment control unit (SCU) by Kongsberg, which can manage multiple CANopen network segments. Optionally, the SCU provides an Ethernet-Powerlink interface running a CANopen-based application layer. The K-Chief 600 propulsion control system is another CAN-connected product by the Norwegian container vessel supplier.

The Finnish company Wärtsilä is a manufacturer of marine engines with embedded CAN communication. As an example, the Wärtsilä 46F medium-speed marine engines with power outputs up to 11250 kW are available in 6- cylinder to 9-cylinder in-line configurations. For condition-based maintenance, the engine provides continuous temperature monitoring of the bearings and the exhaust gas as well as real-time data monitoring of the engine performance. The 46F is equipped with a scalable embedded control system based on five hardware modules controlling engine safety functions, instrumentation, speed control, overall engine functionality, and the electronic fuel

injection. The architecture is based on CAN for communication between the modules and Ethernet connection to the external automation systems. The system also internally implements redundancy on selected systems and components. Recently, Wärtsilä introduced the 46TS-DF engine, which is designed with a focus on efficiency, environmental performance, and fuel flexibility. In gas fuel mode, the engine has the highest efficiency thus far achieved in the medium-speed engine market, said the manufacturer.

### **Dual-mode redundancy also for CAN FD and CAN XL**

The CANopen redundancy concept specified in CiA 307 respectively CiA 302-6 is not suitable for CAN FD and CAN XL. Therefore, Kongsberg and Microcontrol started to develop a generic dual-mode redundancy solution for CAN-based interfaces independent of the used CAN data link layer protocol. It should suit Classical CAN, CAN FD, and CAN XL. It is currently under development in the CiA Interest Group high availability. This dual-mode redundancy approach is based on two independent CAN interfaces each comprising a CAN controller and a CAN high-speed transceiver. There is also a finite state automaton specified, which manages the selection and eventually the swapping of the active and the passive interface. The data frames are always transmitted on both segments, but on the receiving side there is only one line active.

For redundant use, some connectors with their recommended pinning are given in the CiA 106 Technical Report. This document dedicated for all CAN-based higher-layer protocols and CAN generations derives from the CiA 303-1 connector recommendations formerly specified for use with CANopen.

### **NMEA 2000: The J1939-based network for navigation**

End of the 90ties, the US-based National Marine Electronics Association (NMEA) developed the successor of the 4,8-kbit/s NMEA 0183 serial communication link. This approach was based on the CAN lower layers and the ▶



Figure 1: The NMEA 2000 application profile for maritime electronics is especially used in navigation systems (Source: Adobe Stock)

J1939 application layer i.e. using Classical CAN communication with 29-bit CAN-Identifiers. It was named NMEA 2000 and internationally standardized in IEC 61162-3 running at 250 kbit/s. The multi-drop network is not completely interoperable with all features of the J1939 specifications, but can co-exist in J1939 networks. The cabling is similar to Devicenet specifications. The fast packet transport protocol is limited to 223 byte and does not require a segment confirmation. CAN in Automation (CiA) is observing the standardization activities of the NMEA association. According to the organization, there are no plans to migrate to CAN FD or CAN XL.

The CAN-based higher-layer protocol and application profile for maritime electronics is especially used in navigation systems. NMEA 2000 products need to be certified by the non-profit association. Examples of NMEA 2000 devices include GPS receivers, navigation and engine instruments, nautical chart plotters, wind instruments as well as depth sounders. Some companies such as Furuno, Raymarine, and Simrad offer other connectors as specified in NMEA 2000. They sell their products not under the brand NMEA 2000, but use the NMEA 2000 parameter groups (PG).

### NMEA 2000 product suppliers

Of course, there are several providers of CAN-supporting hardware, software, interfaces, and services for the marine industry. The CiA member company Wärtsilä Lyngso Marine (former Søren T. Lyngsø in Denmark) belongs to the Wärtsilä group and develops electronics for the marine applications. The product range includes automation devices as well as communication and navigation systems. CANopen, J1939, and NMEA 2000 higher-layer protocols can be supported.

Warwick Control Technologies (UK) provides the J1939-based protocol stack kit supporting NMEA 2000. It comprises the protocol stack in C source-code, an STM32 development board, an NMEA-certified reference design CAN driver for STM32 micro-controllers, the X-Analyzer tool, and the Leaf Light USB dongle by Kvaser. The C source-code incorporates such J1939 features as address claim, fast packet protocol, BAM (broadcast announce message), connection management data transfer,

### Compass system for demanding environments



The Standard 22 NX gyro compass system provides heading information for safe navigation (Source: Raytheon Anschütz)

Raytheon Anschütz (Germany) developed the modular Standard 22 NX gyro compass system providing heading information for safe navigation. As it needs to operate accurately and reliably in stressing environmental conditions, the company undergone the device to a rigorous testing. In addition to the company's approval test standards, the pre-production units were evaluated for twelve months at the company's production facilities in Kiel, Germany and on a ferry in the Baltic Sea.

The system includes NMEA 2000 interfaces for connection of additional heading receivers or of the bridge alert management (BAM). It also enables a direct connection of rate-of-turn indicators. Two Ethernet interfaces are offered as well. The integrated ship-board webserver simplifies the system's installation. Interfaces are organized by selecting NMEA 2000 telegrams, bit rates, and update rates. Also configurations can be downloaded and uploaded via the webserver. This enables configuration times of few minutes. The system's gyro compass accessories include heading distribution units, operator units, and repeater compasses. It can be integrated into the company's existing Standard 22 and Standard 30 MF systems, and added to the redundant CAN networks using six wires.

etc. The X-Analyzer analysis and simulation tool supports NMEA 2000, J1939, CANopen, and CAN FD. For J1939, it allows to view parameter group number (PGN) packets, compare them to the raw CAN data, and to decode the packets into fields and signals. It also looks for harness/connector problems in the CAN signal. The analyzer supports all Kvaser CAN interfaces, as well as the Picoscope 2206b by Pyco Technology.

Figure 2: The wireless CAN bridge by Kvaser enables CAN communication in situations where wired CAN connection is challenging e.g. in marine applications (Source: Kvaser)



Beside of CAN interfaces, further hardware, and tools, Kvaser offers the recent configuration-free Kvaser Air Bridge Light HS M12. The wireless CAN bridge with ▶

dust and water-resistant M12 connectors can replace CAN cables in marine and other extreme environments. Comprising a pre-configured pair of wireless units with integrated antennas and rugged housings, the bridge exchanges raw CAN data between two networks when a wired CAN connection is challenging. The transmission range is up to 70 m, with a maximum data rate of 1 200 messages per second and a packet latency of 4,8 ms. Although this model incorporates two 5-pin M12 connectors with NMEA 2000 compatible pinning, the bridge is not an NMEA 2000-certified device.

The MLI-E 12/1200 Lithium-Ion battery from Mastervolt comes in a water proof plastic case, recharges in less than an hour, and deep-cycles 5000 times, which is up to 10 times longer than for lead-acid batteries. For integration in mobile and maritime power systems, NMEA 2000 and CANopen protocols are supported. The battery is protected against overcharging, deep discharging, and overheating and comes with an integrated electronic safety switch. The MLI-E is provided with integrated battery monitoring, including information about state of charge and time remaining.



Figure 3: For integration in maritime power systems the NMEA 2000 protocol is supported (Source: Mastervolt)

## Connecting measurement equipment under the sea



Figure 4: The off-shore platforms for oil production are linked to sub-sea CANopen networks comprising redundant controllers, different sensors, valves, and other equipment (Source: Adobe Stock)

CAN networks are used not only above the water surface. Under the sea, diverse sub-sea measurement equipment and control systems can be interconnected via CAN. For instance, the off-shore platforms for oil production are linked to sub-sea trees (nicknamed Christmas trees) comprising redundant controllers, different sensors, valves, and other equipment. These devices are located on the ocean ground in depths up to several hundreds of meters and are connected by means of CANopen networks. Such devices (also known as SIIS level-2 devices) comply to the CiA 443 CANopen profile, which was developed and

## Solar boat project



CAN-controlled hydrofoils allow the SR02 boat to get elevated over the water line, thus reducing the drag forces and the energy consumption (Source: Kvaser)

Since 2015, cross-degree engineering students at Lisbon's Instituto Superior Técnico work together on the development of solar-powered boats. The main purpose of the Técnico Solar Boat (TSB) project is to participate in worldwide engineering competitions. In the Monaco Solar & Energy Boat Challenge (biggest in the world), the SR02 boat developed by the students took the 2<sup>nd</sup> place on the podium (A-class) in 2019. The team competed with 34 teams from 14 different nationalities. In a remote competition in 2020, the students won the innovation prize among the eleven participating teams. As there was no further competition in Monaco, the university started its own Odisseia TSB event, traveling along the Portugal coast, doing some crossings, and testing the boat's capabilities.

The SR02 boat implements a CAN-based system to control the motors, the hydrofoils system, and to check the state of temperatures, voltages, currents, etc. The hydrofoils allow the boat to get elevated over the water line, which reduces the drag forces and the energy consumption. While development, the Kvaser Canking software was used to monitor and analyze the CAN traffic. The Kvaser Memorator Pro 2xHS v2 interface and Kvaser Database Editor helped to log data from the vessel for further analysis. A self-developed Matlab App allowed to extract required data from a .mat file generated with the Kvaser Memorator configuration tool. This enabled the team to evaluate the data from a desired period of time, to see the variables' change along a travelled distance, or to check the boat position for each instant of time.

The students are currently developing their third solar-powered boat SR03, and finishing its first hydrogen-powered boat São Miguel 01 (SM01), which will also use the Memorator Pro 2xHS v2 CAN interface with dedicated software.

is maintained by CiA in cooperation with the SIIS (Subsea Instrumentation Interface Standardization) group. The SIIS level-1 specifies discrete analog interfaces and the SIIS level-3 defines Ethernet interfaces.

The devices are controlled by an application manager, which is not specified in the CiA 443. Often, two manager entities are integrated into the network providing NMT (network management) “flying” manager functionality as specified in CiA 302-2. The virtual device concept of the CiA 443 profile enables a SIIS level-2 device to provide a sub-layered network or serial links. Thus, it acts as a gateway and provides proxies for the connected functional elements (e.g. different sensors). This means, SIIS level-1 devices can be easily integrated into SIIS level-2 networks. Of course, the sub-layered network may also comply with CiA 443. Two different physical layers are specified. Besides the low-power, fault-tolerant transceivers (compliant to ISO 11898-3) optionally high-speed transceivers (compliant to ISO 11898-2) are allowed. The default bit rate is 50 kbit/s and the bit-rate of 125 kbit/s is required as well. The SIIS group organizes plugfests, where the interoperability of CiA 443 compliant devices can be proven.

## CAN in underwater vehicles



Figure 5: The 3,5-m-long AUV weighs less than 700 kg and provides a slim CAN architecture (Source: Fraunhofer IOSB-AST)

There is a growing demand for underwater vehicles. Several thousand meters below the surface, oil companies are prospecting for new deposits and deep-sea mining companies are looking for valuable mineral resources. The thousands of kilometers of pipelines and submarine cables need a regular maintenance. Additionally, the marine scientists would like to be able to use robust underwater exploration vehicles to survey large areas of the ocean floor.

To meet these demands, researchers at the Fraunhofer Institute for Optronics, System Technologies and Image Exploitation IOSB in Ilmenau and Karlsruhe have developed an autonomous underwater vehicle (AUV) using internal CAN communication. The development of the vehicle, which should be manufactured in large numbers, was finished in 2016. The companies have been using AUVs in deep-sea exploration missions for many years. Formerly used vehicles have been custom-built and expensive. They have had complex structures, which made them difficult to access by the vessel crew, e.g. when replacing the batteries. It took also more than one hour to read the large observation data files from the UAV’s on-board processor. Many of these vehicles were also so heavy, so that

only specially trained operators could place them into the water using the ship’s winch.

The IOSB’s AUV called Dedave (Deep Diving AUV for Exploration) and resembling on a space shuttle, overcame these problems. It is capable of diving to depths of 6000 m. The embedded CAN system reduces cabling complexity. It consists of a slim cable to which all control devices, electric motors, new modules, sensors, or test devices can be connected. Batteries and data storage devices are held in place by a simple latch mechanism, allowing them to be removed with a minimum of effort. There is also no need to download data from the processor. Because of the weight (less than 700 kg) and size (3,5 m long), four Dedave AUVs can found place in one standard shipping container. Usually there is only enough room for one vehicle. Therefore, larger than usual areas of ocean can be surveyed in less time. The additional carrying space (ca. 1 m in length) is sufficient for installing further different sensors for capturing ocean floor survey data.



Figure 6: Replica of the Avro Canada CF-105 Arrow (Source: Ken Mist, CCSA)

In 2017, the Dedave UAV has been licensed by the Canadian maritime technology company Kraken Robotics, who have renamed it to Thunderfish Alpha. Since the end of July, the underwater robot has been helping the company to hunt down the Avro Canada CF-105 Arrow interceptor aircraft in the waters of Lake Ontario. While the aircraft’s development and testing phase, conducted from the shore of Lake Ontario, some jet prototypes and their parts were scattered over a large portion of the lake. In September, the UAV located the first and shortly after a second model of the Arrow jet, for which people have been looking for 50 years. Based on acoustic echoes, the diving robot generated sonar images in real-time, which were analyzed by the experts directly after the dive. Image data could be transferred wirelessly, and gave precise indications of potential item locations.

Also in 2016, the 25-students team Sonia of École de Technologie Supérieure in Montreal started to build an autonomous underwater vehicle using modular CAN architecture inside the vehicle.

The hardware within the submarine included a navigation system, cameras, six motors, a bright light, a torpedo launcher (a demonstrator version), and two small robotic arms. For connection of the CAN network to a PC, Sonia has

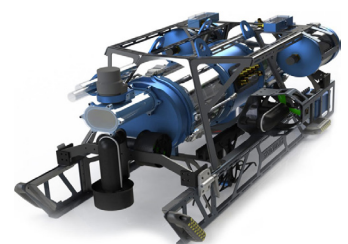

Figure 7: The Sonia AUV dives with Kvaser interfaces (Source: Kvaser)

used the Kvaser USB-CAN II interface for many years and then a Kvaser Leaf Pro HS v2. As Linux users, the team chose Kvaser CAN hardware because of company's support for both Windows and Linux. The students used open-source software and have also created an open-source package for robotic systems that interface with Kvaser devices. The interface is built on ROS (robotic operating system), a popular middleware for robotic projects.

### For actuation under water

As an example for CAN-connectable devices deployed in submarines, Olsen Actuation (UK) provides the OLX linear and ORX rotary actuators withstanding pressures up to 300 bar. Optionally, the devices come with integrated servo drive electronics and multi-axis operation. Further options include secondary redundant sealing systems, salinity sensors, temperature sensors, and pressure-level sensors. Manual docking, side- or rear-drive, visual position indication, diverse mounting arrangements, as well as marine subsea-rated cables are offered. Customization of the actuators e.g. regarding housing materials, is possible. OLX and ORX actuators are built around the company's Exlar GSX actuators, which has been proven time and again on Virginia Class nuclear submarines. The devices are suited for applications in submarines such as winch brake control, winch cable guide control, umbilical cutters, hatch and door actuation, sonar array cutters, and sonar mast deployment. They also find application in pipeline inspection tools, thrusters, and manipulators.

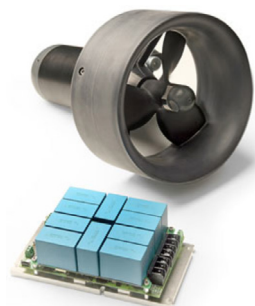

Figure 8: The CANopen i127 servo drive is dedicated for thruster control on under-water vehicles (Source: Ingenia)

The Spain manufacturer Ingenia Motion Control provides the CANopen i127 brushless AC motor servo drive including pressure-tolerant electronics. Dedicated for operation at up to 1600-m deepness (up to 160 bar), it can be used for control of propulsion systems on manned submarines, AUVs, ROVs (remotely operated vehicles), or other underwater vehicles. The device implements the CANopen device profile for drives and motion control (CiA 402 and IEC 61800-7-2/-3). Historically, electronic

systems for deep-water applications have been installed inside of low-pressure vessels. Working with pressure-tolerant electronics reduces the weight and volume of containers as well as the number of connections through pressure barriers. The power and electronic systems are not placed in the submarine cabin. Less complex and reliable cooling systems are required. Use of such electronics also reduces system complexity and increases reliability. Thereby, several design issues should be considered. Full isolation between power and logic connections should be given. Dynamic braking should be done through on-board high-power shunt braking resistor. For operation, full disconnection from batteries should be achieved. Furthermore, on-board self-monitoring

### Proprietary CAN solution for maritime systems



The E-POD propulsion solution is one of company's example products, which can be connected to the Vetus network (Source: Vetus)

Vetus (Germany) has designed a proprietary V-CAN (Vetus Controller Area Network) system, which is intended for company's products only. The company has also manufactured gateways, which communicate between the V-CAN system and devices implementing J1939 or NMEA 2000 higher-layer protocols. The firm assisted the NMEA organization in the implementation of thruster and electric propulsion to operate on that network.

The proprietary protocol enables the company to stay in control and maintain the safety factors implemented within its products. External control or monitoring by other systems requires manufacturer's approval. This can be done either via a gateway to the other system, or through approved use of the V-CAN command structure.

systems for voltage, current and temperature supervision are required. Protection systems should not provide non-resettable devices i.e. all protections should be electronic.

### Summary and outlook

CAN is broadly used over and under the sea because of its high reliability, price-performance ratio, and available off-the-shelf hard- and software infrastructure. Advanced standardization of CAN-based communication interfaces enables simplified development, integration, and replacement of devices.

Redundant use of devices and networks is a must for the maritime applications. CiA and its members is currently working on a generic dual-mode redundancy solution for CAN-based interfaces independent of the used CAN data link layer protocol. It should suit Classical CAN, CAN FD, and CAN XL.

NMEA 2000 uses Classical CAN communication with 29-bit CAN-Identifiers. The association is not (yet) willing to use CAN FD and CAN XL. The features of Classical CAN (bit-rates of up to 1 Mbit/s and payload size of up to 8 byte) seem to be sufficient for such maritime applications.

For electronics used under the water, special design issues have to be considered. These relate to the housing robustness, pressure-compensation, isolation of power ▶

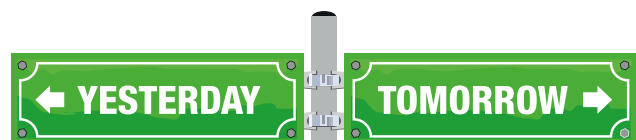



## J1939 analysis for ship telematics



Vives recorded data from the GEOxyz maritime vessel  
(Source: CSS Electronics)

Vives is the largest university of applied sciences in West Flanders (Belgium) with campuses in five student cities. The university participated in a European-funded project ISHY (implementation of ship hybridization) that wants to achieve 50 % of CO<sub>2</sub> reduction on medium ships. The project researches the possibility to use fuel cells, battery supply, and hydrogen in ships in place of heavy fuels.

To calculate the size of the alternative power supplies exactly, the project members needed to know how much power the combustion engines deliver at any time. The examined GEOxyz vessel has two engines (port and starboard) interconnected via two J1939 networks. Therefore, the actual engine speed and the actual engine torque values coming from the two in-vessel networks were monitored and logged. With those two parameters it was possible to make a power profile of the combustion engines. The CANedge2 data logger by CSS Electronics was used for logging of these parameters. Further, the researchers wanted to know why the engines require this amount of power. For this, a third network was set up and the data was logged by a second CANedge2 device. On this network, a GPS (global positioning system) receiver, IMU (inertial measurement unit), wind speed sensor, wind direction sensor, wave sensor (and more) were implemented. The two CANedge2 units uploaded the log files from their SD cards via the 4G mobile network to the third-party S3 server from AWS. Finally, the data could be displayed on a monitor in the office using the Grafana dashboard software tool.

supply, cables and connector protection, and many more. In the meantime, there is a number of companies offering a long-term experience and support for CAN-based (sub-)marine product developments.

### Author



Olga Fischer  
CAN Newsletter  
[pr@can-cia.org](mailto:pr@can-cia.org)  
[www.can-newsletter.org](http://www.can-newsletter.org)



## Vollständig integrierte Automatisierung für mobile Maschinen - X90

Komplettes Portfolio:  
[www.br-automation.com/mobile-automation](http://www.br-automation.com/mobile-automation)

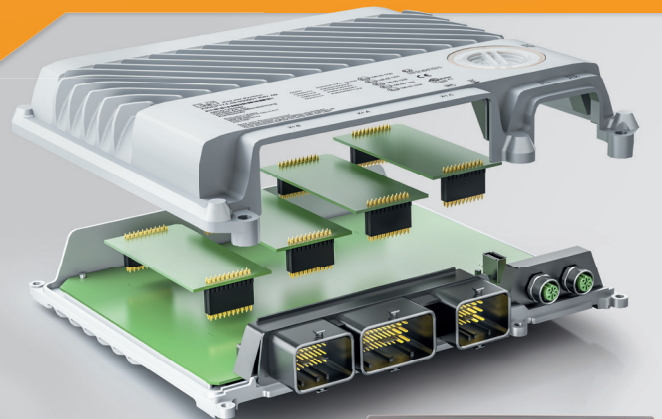

- Einfache Handhabung
- Integrierte Sicherheitstechnik
- Schnellere Entwicklung



PERFECTION IN AUTOMATION  
A MEMBER OF THE ABB GROUP



## History and trends:

# CAN in air and space

*The CAN Newsletter magazine reported already in its cover story of the December 1996 issue about the FDR1-CAN flight data recording system. Nowadays, CAN is used in Boeing and Airbus aircrafts, in helicopters, in drones, and even in satellites in the outer space.*

(Source: Adobe Stock)

In 1996, the Aviat Pitts Special S-2B aircraft tested the CAN-connected flight data recorder for 28 flight hours without any problems. The modular system was developed by Michael Stock. He is also the main inventor of the [CANaerospace higher-layer protocol](#). It is suitable for airborne systems employing the line-replaceable unit (LRU) concept. In order to avoid unacceptable frame transmission delays, CANaerospace recommends to limit the bandwidth usage to 50 percent. This means even in case of error frames, there is enough margin to overcome temporary fault situations.

CAN has also been used in flight simulators for entertainment or training purposes. These systems reproduced the cockpit of an aircraft as realistically as possible. Traditional architectures of flight simulators use several personal computers and point-to-point connections to link the cockpit devices with the simulation software. A paper from CAN in Automation's (CiA) 16<sup>th</sup> international CAN Conference (iCC) from 2017, described the development of CAN-based modules for A320 flight simulators. The recorded presentation can be watched [here](#). The used application layer is based on the above-mentioned CANaerospace and provides users with the ability to ask for the identification of the devices, to change the Node-ID, to configure some of the modules and to automatically configure the bit rate. Another paper of the 16<sup>th</sup> iCC introduced CAN FD in aviation. It can be watched [here](#). The [international CAN Conference](#) is a platform for presentations of CAN developments. Experts from all over the world and from the most-diversified application areas have met for years at this international event.

Another iCC paper in 2006 from Airbus introduced [CAN-connected smoke detectors](#). The company, explained: Within the fire protection system on an Airbus, smoke detectors are installed in various areas overall in the pressurized zones of the aircraft such as lavatories, equipment bays, and cargo compartments. As the CAN defines only layers 1 and 2 of the OSI communication model, additional higher layer features are necessary to achieve the level of operational assurance required for a safety critical application, namely fire protection on an aircraft. This paper particularly focused on the development of a safety critical CAN network with strict configuration control of smoke detectors in the scope of an aircraft application.

In 2012, Airbus again was part of the iCC and reported about the [standardization of CAN networks for airborne use through Arinc 825](#). The Arinc 825 higher-layer protocol

is based on some ideas from CANaerospace. The first usage was in the Airbus A350 aircraft. Of course, applicable regulatory documents published by the FAA, EASA and/or other regulatory bodies need to be considered, too. In some aircrafts such as the Airbus A380 and Boeing 787, are about 80 to 250 CAN networks in duty. They are often connected to an Ethernet-based backbone network compliant with the Arinc 664 (AFDX) specification. Arinc 825 uses only the data frames with 29-bit identifiers. In the [Supplement 4 of the Arinc 825](#) the usage of CAN FD is specified. The bit rate is 4 Mbit/s.

## CAN in drones

Modern unmanned aerial vehicles (UAV) debuted as an important weapon system in the early 1980s. Israeli Defense Forces fitted small drones resembling large model airplanes with trainable television and infrared cameras and with target designators for laser-guided munitions, all downlinked to a control station. Nowadays, many of such combat drones use embedded CAN networks, the [CAN Newsletter Online reported](#). But also drones for leisure purposes are equipped with embedded CAN networks. The drone community has developed the open-source UAVCAN higher-layer protocol. It is a simple application layer. [DroneCAN](#) was created to continue the development of the UAVCAN v0 protocol. The proposed introduction of the UAVCAN version 1 protocol involved changes to UAVCAN that increased complexity and did not offer



Figure 1: In 2017 at iCC, Ana Antunes from Instituto Politécnico de Setúbal, introduced a paper which described the development of CAN-based modules for A320 flight simulators (Source: Adobe Stock)



Figure 2: In some aircrafts such as the Airbus A380 and Boeing 787, are about 80 to 250 CAN networks in duty (Source: Adobe Stock)

a smooth migration path for existing deployments. DroneCAN is the CAN-based high-layer protocol used by the Ardupilot and PX4 projects for communication with CAN peripherals. It is an open protocol with open communication, specification, and multiple open implementations. It supports CAN FD as well as Classical CAN.

The included DroneCAN transport layer supports unconfirmed multi-segment broadcast communication as well as a confirmed multi-segment communication. In the multi-segment approach an embedded CRC (cyclic redundancy check) sequence is transmitted in the first segment. Additionally, a toggle-bit ensures the detection of double-transmission of frames in case of a dominantly-detected last bit of the End-of-Frame field by the sender.

DroneCAN does not require nodes to undergo any specific initialization upon connecting to the network – a node is free to begin functioning immediately once it is powered up. The only application-level function that every node needs to support is the periodic broadcasting of the node status message.

The open-source higher-layer protocol references some CiA documents such as CiA 303-1 for connector pin-assignments and CiA 103 for the physical layer. It is recommended to provide two identical parallel connectors for each CAN interface per device, so that the device can be connected to the network without the need to use ▶



Figure 3: For example, the Phantom 2 drone from the company DJI provides CAN connectivity (Source: DJI)

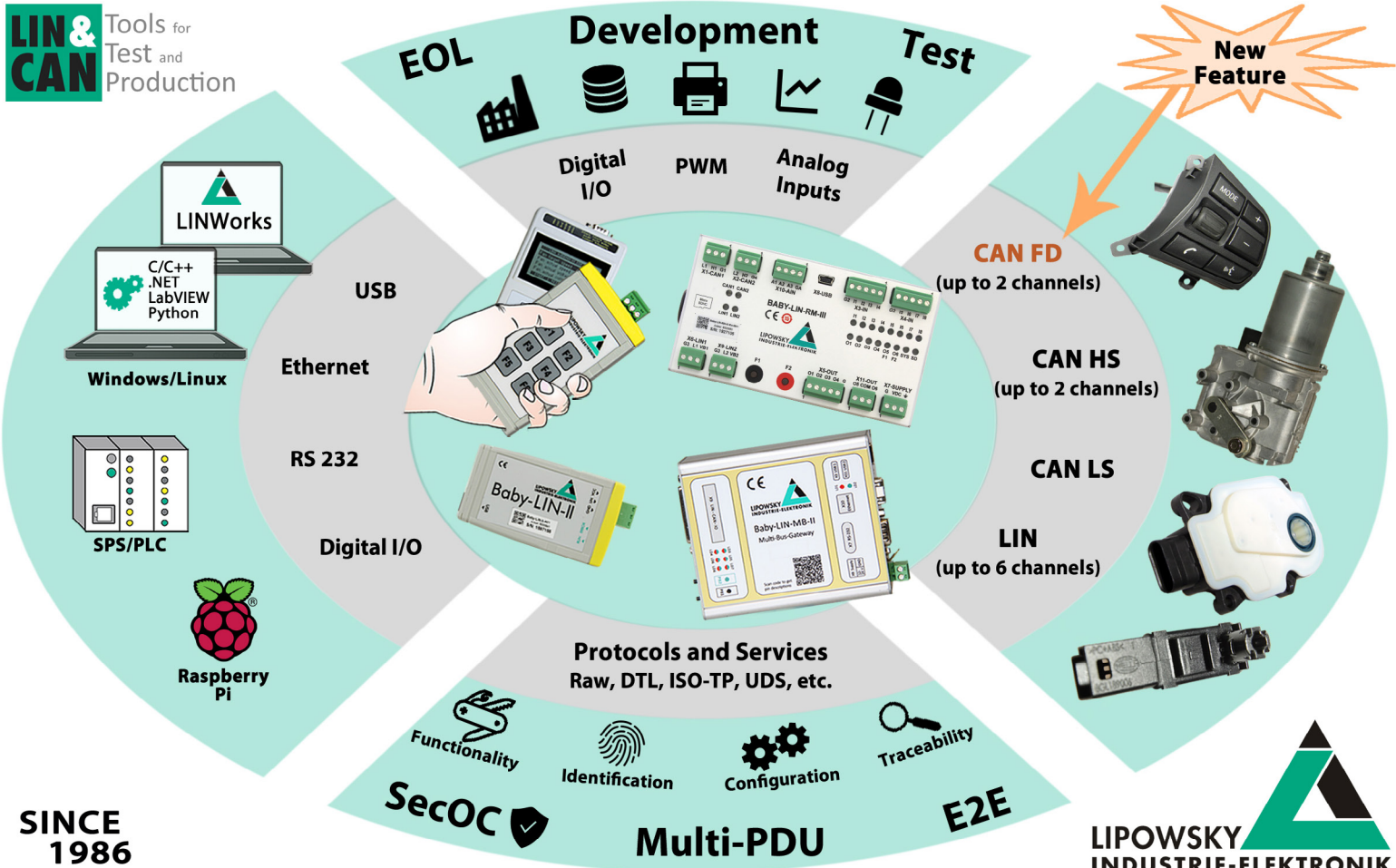

SINCE 1986

www.lipowsky.com

info@lipowsky.de

+49 6151 93591-0

ISO 9001 : 2015

Distribution China: Hongke Technology Co., Ltd  
Distribution USA: FEV North America Inc.

Ph: +86 400 999 3848  
Ph: +1 248 293 1300

sales@hkaco.com  
marketing\_fev@fev.com

www.hkaco.com  
www.fev.com



Figure 4: CAN is also found in space; ESA has chosen CAN as embedded network in some of its satellites. Additionally, ESA and satellite suppliers have developed a CANopen subset as higher-layer protocol. (Source: Adobe Stock)

T-connectors. They should be avoided, because they add an extra point of failure, increase the stub length and weight.

Mission-critical devices and non-mission critical devices often need to co-exist on the same DroneCAN network. Therefore, all devices should be connected to the primary CAN network. The mission-critical ones are connected to one or two additional backup CAN networks. DroneCAN is bit rate agnostic, so technically any bit rate can be used as long as it is suitable for the chosen network topology. However, only the recommended bit rates (1 Mbit/s, 500 kbit/s, 250 kbit/s, or 125 kbit/s) should be used to ensure compatibility. The sample-point should be located at 75 % of the bit time. The given maximum network length recommendations seem to be optimistic. Designers are encouraged to implement automatic bit rate detection with reference to the [CiA 801](#) application node. CiA 801 CANopen automatic bit rate detection, describes the recommended practice and gives application hints for implementing automatic bit rate detection in CANopen devices. With the layer setting services (LSS) it is possible to change the bit rate in CANopen networks.

### CAN in the outer space

The European Space Agency (ESA) has chosen CAN as embedded network in some of its satellites. Additionally, ESA and satellite suppliers have developed a CANopen subset as higher-layer protocol. This subset is specified in the ECSS-E-ST-50-15C document. ESA organized several “CAN in space” workshops. In summer 2017, they organized one in the south of Italy. It took place in the facilities of CiA member Sitael implementing CAN and CANopen completely in Asics. About 60 engineers from ESA, satellite suppliers, device makers, and semiconductor vendors participated in the three-day event. “CAN for space is a true ESA success story,” said ESA’s Gianluca Furano. Since several years, CiA member ESA develops jointly



### CAN Newsletter Online

The CAN Newsletter Online already reported several times about applications and products regarding CAN in the air and space. Here a few examples:

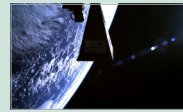

#### Aerospace **“Selfie” of CAN in space**

Surrey Satellite Technology (SSTL) has announced the successful launch of TechDemoSat-1, an in-orbit technology demonstration mission for UK spacecraft equipment and software. The satellite’s internal communication runs via a CAN network.

[Read on](#)



#### Sensor box **Teaching cars to fly**

Bosch supports flying taxis by its sensor box originally developed for automotive applications. CAN or CAN FD connection is provided as well as SAE/Arinc 825-4 functionality.

[Read on](#)

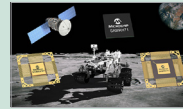

#### Radiation-hardened MCUs **CAN FD micro-controllers for space systems**

Microchip expanded its Arm Cortex-M7 MCU (micro-controller unit) family for space applications by the SAMRH707 MCU and the SAMRH71 MPU (micro-processor unit).

[Read on](#)



#### Servo drive **CANopen controls helicopter drone rotor**

The TD220 unmanned aerial vehicle (UAV) uses Hornet CANopen servo drives from Elmo (Israel).

[Read on](#)



#### CAN Newsletter magazine **Electric propulsion demonstrator**

NASA and several partner firms led by Empirical Systems Aerospace have worked on the X-57 Maxwell electric propulsion demonstrator, which uses several CANopen networks.

[Read on](#)



#### Aerospace **CAN on Mars**

After seven month, the Trace Gas Orbiter (TGO) of ESA’s Exomars 2016 has reached the Red Planet. Contact with the mission’s test lander from the surface has not yet been confirmed.

[Read on](#)



#### Flying cars **Driving in 3D**

Flying is a very old human dream. In Monaco at the Top Marques event, two companies demonstrate flying cars.

[Read on](#)



#### Aircraft and other applications **CAN modules for unmanned systems**

Innodisk recently released their latest CAN modules. The products come with various form factors and are suitable for use in unmanned systems such as aircraft applications. They also support J1939 and CANopen.

[Read on](#)

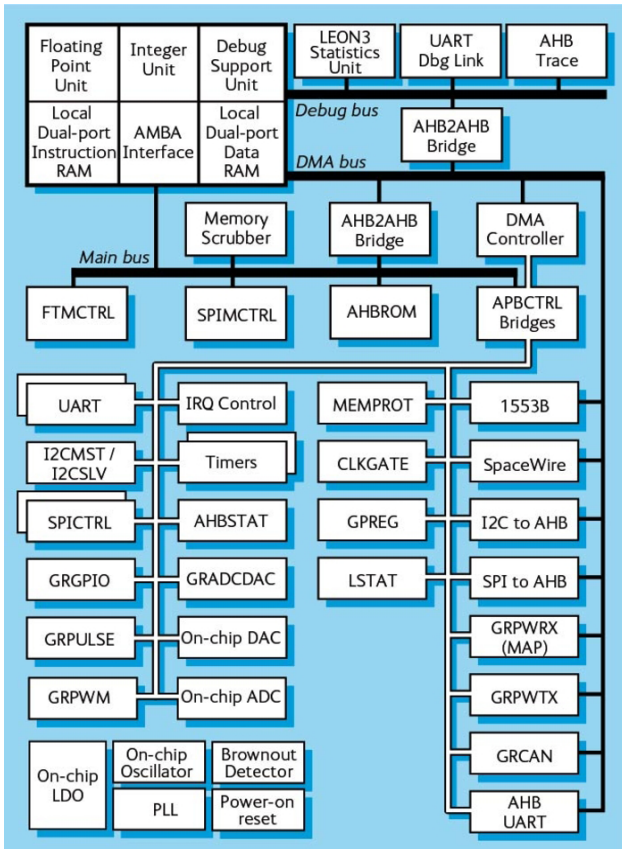

Figure 5: In 2019, the radiation-tolerant mixed-signal MCU GR716 by Cobham Gaisler has been introduced. It features two CAN interfaces (Photo: Cobham Gaisler)

Classical CAN and now on CAN FD. Arinc 825-4 specifies the CAN FD usage for aircraft and DroneCAN supports CAN FD, too. Perhaps the airborne industry migrates to CAN XL, the third CAN protocol generation very soon. The reliability and robustness of the CAN lower layers are important features for these industries. ◀

with the supplying industry CAN-based solutions for satellite designs. For more details, read [this article of the CAN Newsletter from 2017](#).

In June 2019, ESA and Cobham organized another CAN in space workshop in Gothenburg, Sweden ([the CAN Newsletter Online reported](#)). It focused on CAN micro-controllers and CANopen implementations. CiA provided a brief introduction into CAN FD and CANopen FD. Other speakers reported about their experiences of CAN and CANopen in space applications. About 80 participants joined the workshop. What was clear in all presentations is the trend to use ISO 11898-2 compliant transceivers. Of course, they needed to be radiation-tolerant. Cobham Gaisler, Microchip, and Renesas (formerly Intersil) showed their implementations.

As already mentioned, to use CAN in the outer space, it requires radiation-resistant micro-controllers with embedded CAN protocol controllers and radiation-resistant CAN transceivers. In the first satellites, EIA-485 transceivers have been used. Nowadays, several companies offer ISO 11898-2 compliant transceivers which are radiation resistant. In 2019, Cobham Gaisler introduced its radiation-tolerant GR716 micro-controller with CAN. It features on-chip A/D and D/A converters as well as other signal processing circuitry ([the CAN Newsletter Online reported](#)).

### Next steps and outlook

CAN is in the air: Aircrafts, drones, satellites use CAN networks successfully since many years. First based on

#### Author

Cindy Weissmueller  
CAN Newsletter  
[pr@can-cia.org](mailto:pr@can-cia.org)  
[www.can-newsletter.org](http://www.can-newsletter.org)



# Standards and specifications



(Source: Adobe Stock)

*This section provides news from standardization bodies and nonprofit associations regarding CAN-related documents. Included are also recommended practices, application notes, implementation guidelines, and technical reports.*

## ***End-of-life activation of in-vehicle pyrotechnic devices***

ISO has released the ISO 26021-1 document. It standardizes the application and communication interface for end-of-life activation of in-vehicle pyrotechnic devices. This standard describes use cases and specifies technical requirements in order to support the end-of-life activation of in-vehicle pyrotechnic devices via electronic communication interfaces. This document references the ISO 14229 series (unified diagnostic services implemented on diagnostic communication over DoCAN Classical CAN or DoIP Internet Protocol transport layers). In practice, most passenger cars use the CAN-based solution. Part 2 of the ISO 26021 series is still in development. It specifies the conformance test plan for the communication interfaces standardized in ISO 26021-1. ■

## ***SAE J1939 related documents***

SAE has released a new version of the J1939 digital Annex, which includes parameter group (PG) and suspect parameter (SP) specifications. This document is provided as Excel spread sheet and is updated quarterly.

Additionally, the nonprofit association has published a revised version of the J1939/14 physical layer recommended practice (500 kbit/s). The new J1939/14 version has been harmonized with other J1939 physical layer specifications. It is limited to Classical CAN applications; it does not support CAN FD. The SAE J1939/17 document specifies the CAN FD physical layer. ■

## ***ISO 11898-1 and ISO 11898-2 under review***

ISO is reviewing the CAN data link layer and physical signaling sub-layer (ISO 11898-1) and the CAN high-speed physical medium access sub-layer (ISO 11898-2). It is planned to integrate the CiA 610-1 respectively the CiA 610-3 CAN XL specifications. In a second step, the related conformance test plans standardized in ISO 16845-1 respectively ISO 16845-2 will be updated. CiA prepares them and will submit the CiA 610-2 and CiA 610-4 documents, when these have been finalized. Currently, they are still under development. ■

## ***New edition of ISO 14229-3***

ISO has released the second edition of UDSONCAN (unified diagnostic services on CAN) implementation. The ISO 14299-3 document specifies an application profile for the implementation of unified diagnostic services (UDS) on CAN. It references the generic application, presentation, and session layers as specified in ISO 14229-1 and ISO 14229-2. Additionally, the standard references the CAN data link layer and high-speed CAN transceiver as specified in the ISO 11898 series. It makes use of the transport and network layers given in the DoCAN standards ISO 15765-2 respectively ISO 15765-5. ISO 14229-3 does not specify any requirement for the in-vehicle CAN architecture.

The main changes in the new edition include the restructuring of the document, the introduction of requirement numbers, names, and definitions as well as technical improvements based on implementation feedback from the automotive industry. ■

## Tachograph standard updated

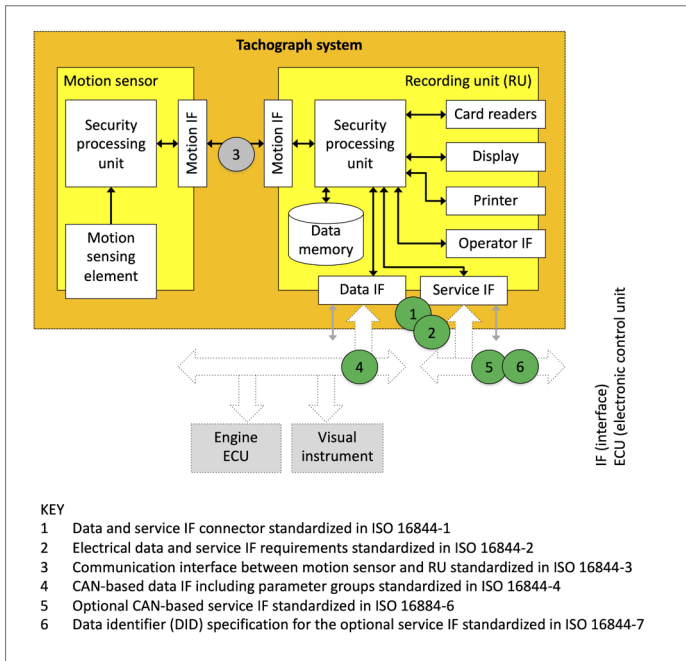

Block diagram of an ISO 16844 compliant tachograph system with CAN connectivity (Source: CiA)

The ISO 16844 standard series specifies tachograph systems for commercial road vehicles. The entire series is under review. The first parts of the third edition have been released (Part 1: Electromechanical components; Part 2: Electrical interface with recording unit). The parts specifying the CAN interfaces are Part 4 (Display unit communication interface), Part 6 (Diagnostics), and Part 7 (Parameters). The CAN interfaces use the J1939 application layer specifications. Part 6 provides also an optional K-line communication.

## CiA profile specifications to be released

CiA is going to release the following profile specifications as Draft Specifications in the next few weeks or has done it already:

- ◆ CiA 444 series (CANopen profile for container-handling machine add-on devices)
- ◆ CiA 445 (CANopen profile for RFID devices)
- ◆ CiA 450 (CANopen device profile for pumps)
- ◆ CiA 453 (CANopen device profile for power supply)
- ◆ CiA 459 series (CANopen profile for on-board weighing devices)
- ◆ CiA 462 (CANopen profile for item detection devices)
- ◆ CiA 463 series (CANopen interface profile for IO-Link gateways)

CiA documents in Draft Specification (DS) status can be purchased by means of an annual subscription of CiA document series (e.g. CiA 3XX, CiA 4XX, or CiA 6XX).

## CiA SIG fire-fighting

This SIG (special interest group) backs the development of DIN standards related to fire-fighting trucks. This includes the DIN 14704 standard (gateway to in-vehicle networks) and the DIN 14700 standard (specific fire-fighting units such as water cannon unit (WCU), portable water-pump unit (PWU), powder extinguishing unit (PEU), etc. This standard is also known as FireCAN specification.

The SIG is currently discussing the requirements for the telematic gateway unit (TGU) as specified in DIN 4630 (truck body application network). This standard is under review and new fire-fighting specific body application units (BAU) can be submitted. Besides the FireCAN unit (FCU), this could include an AWP (aerial working platform) unit, a TTL (turntable ladder) unit, and an OCU (outrigger control unit). When these units are not considered in the new DIN versions, CiA (CAN in Automation) is going to specify them as CiA profile specifications.

## CiA works on dual-mode redundancy

The IG (interest group) high-availability develops the CiA 701-1 document specifying a network layer add-on function for dual-mode redundancy (DMR). This was originally desired by the maritime electronic suppliers. It is assumed that such nodes implementing the DMR function provide two independent CAN interfaces. They send simultaneously identical data frames on both network interfaces. But on the receiving side only the data frame of the active network is processed. This is done by the DMR add-on function of the network layer.

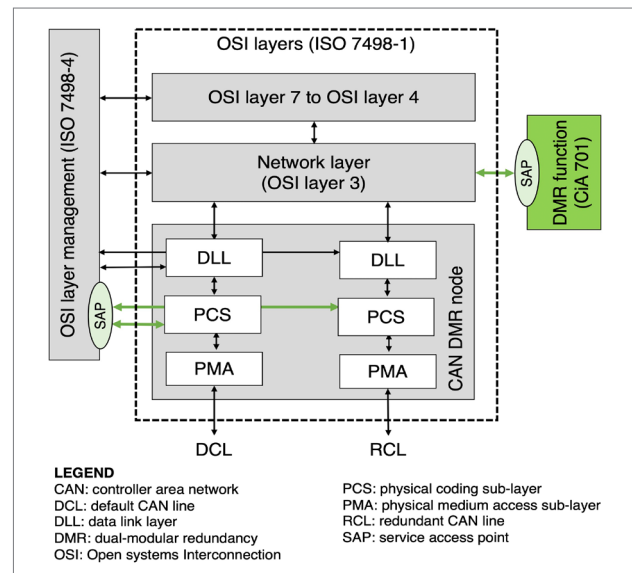

The relation of the DMR function to the OSI layer model (Source: CiA)

The switching of the active receiver function from one CAN interface to the other CAN interface is controlled by a finite state automaton as specified in CiA 701-1. The IG has already developed a work draft, which is out to CiA members for comments. Of course, this DMR function is not limited to marine applications.

# ISO 14229 UDS protocol: Automotive diagnostics

The UDS (Unified Diagnostic Services) protocol is defined in the ISO 14229 series. Automobile OEMs (original equipment manufacturer) follow this standard to provide a common computer system that can be used to diagnose any vehicle.

The automotive industry is drastically evolving, with the main reasons behind this evolution being the increased need for safety and improved driving experience. Cars on the road today contain 40 to 150 individual ECUs (electronic control unit), each performing specific functions such as electronic fuel injection (EFI), engine control, door locks, braking, window operation, and more. Increased complexity requires more efficient ways to test and diagnose vehicle systems when a fault occurs. There have been many diagnostic protocols such as KWP2000, ISO 15765, and K-Line developed over time for vehicle diagnostics. So, to ensure universal compatibility, OEMs and suppliers agreed to rely on a standard protocol which is named as UDS protocol.

UDS is the latest automotive vehicle diagnostic protocol used to diagnose vehicles worldwide. This protocol is defined in the ISO 14229 standard and automobile OEMs follow this standard to provide a common computer system that can be used to diagnose any vehicle.

## Architecture of UDS protocol

Nowadays, the utilization of the protocol is increasing due to its flexibility. This protocol is derived from the ISO 14230-3 (KWP2000) and ISO 15765-3 (Diagnostic Communication over CAN (DoCAN)). It is used for the vehicle diagnostic, ECU firmware flashing, and many more such functions.

The UDS protocol uses fifth (session layer) and seventh (application layer) layer of the OSI model while the CAN protocol works on the first (physical layer - ISO 11898-2) and second (data link layer - ISO 11898-2) layer of the OSI model.

## Diagnostics in a vehicle

The protocol is defined for two types of devices, namely, server and client. The vehicle will be the server and the diagnostic device will be the client. Recent vehicles are equipped with a diagnostic interface, which makes it possible to connect a computer or diagnostics tool, to the communication system of the vehicle (ECU). UDS requests are sent to the controllers, which provide a positive or negative response. With these responses provided from the controller it is possible to diagnose faults and undesirable behavior inside vehicles such as:

- ◆ Data stored within the system
- ◆ Memory available in the individual control units
- ◆ Live vehicle data such as engine or vehicle speed

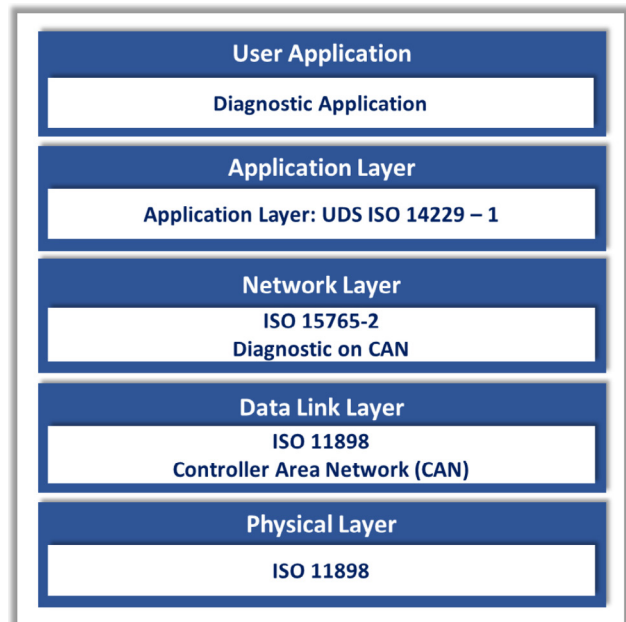

Figure 1: Architecture of UDS protocol (Source: iWave)

- ◆ Firmware updates
- ◆ Interaction with hardware I/O to turn specific output on or off based on the response to identify the fault
- ◆ Run specific functions to understand the environment and operating conditions of an ECU

## Diagnostic services of UDS protocol stack

iWave offers the UDS protocol stack, which is compliant with the ISO 14229 standard and implements both the application layer (ISO 14229-1) and session layer (ISO 14229-2). The UDS stack enables diagnostics such as UDSONCAN and UDSONIP for both client and server implementations. The UDS protocol offers six different client services for the categories of tasks to be performed on the server such as:

- ◆ Diagnostic and communication management
- ◆ Data transmission
- ◆ Stored data transmission
- ◆ Input/output control
- ◆ Remote activation of routine
- ◆ Upload/download

The company has designed the UDS protocol stack to be fully customizable, allowing users to specify feature sets and fine-tune the stack to meet end application requirements of the client device. Value proposition of ▶



## CANopen, J1939, and UDS protocol stacks



*The protocol stacks and its application fields (Source: iWave)*

CAN network technology finds use in many applications. With the boom in Industry 4.0 and connected mobility applications, there is an increase in the requirement for monitoring and diagnostic tools based on CANopen, J1939, and UDS (which is already explained in the article). CAN protocols will see increased use as there are many vehicle manufacturers entering the market, especially in the electric vehicle segment. iWave Systems has developed protocol stacks for CANopen, J1939, UDS, and other industrial and automotive applications to help new players focus on their product development.

The iWave J1939 protocol stack is compliant with the SAE J1939 standard. It implements the data link layer (J1939-21), vehicle application layer (J1939-71), diagnostics application layer (J1939-73), and network management (J1939-81). Other layers of the standard such as J1939-31 can be provided optionally as an add-on. This protocol stack can be used in heavy-duty environments and is also applicable for light-duty, medium-duty, and heavy-duty vehicles used on-road and off-road. The J1939 protocol also forms the base for a number of other protocols such as ISO 11992 and ISO 11783.

The CANopen stack implements all the services compliant to the CiA 301 specification and the features compliant to the CiA 302 specification. To support the various application profiles, iWave provides add-on modules and services for customizing and porting the stack. The CANopen stack can be used for a multitude of applications such as truck gateways (CiA 413), special-purpose car add-on devices (CiA 447), grid-based photovoltaic systems (CiA 437), battery and charger (CiA 418/419), and municipal vehicles (CiA 422).

UDS protocol stack include: easy-to-use APIs (application programming interface), end-to-end solution offerings for telematics solutions, supported in all available kernel versions as well as development of APIs for integration with customer-specific hardware platform and application. ◀

### Author

Pooja Todakar  
iWave Systems  
[mktg@iwavesystems.com](mailto:mktg@iwavesystems.com)  
[www.iwavesystems.com](http://www.iwavesystems.com)



# Feeding cows in the 21<sup>st</sup> century

*Livestock must be fed multiple times a day, 365 day a year. Mixer-feeders can support this process. They are designed for farms with a large number of animals. Sgariboldi (Italy) chose Epec (Finland) units for its added Titanium series.*

Figure 1: The self-propelled mixer-feeders (Source: Tritecnica)



Heading south from Milan, the landscape shows farms, fields, and industries. In this setting Sgariboldi, one of the main mixer-feeders builders in Italy, placed its headquarters; from here its machines, always equipped with cutting-edge technology, are exported all over the world. Mixer-feeder operation, in principle, is very simple: the various ingredients for cows food are cut, optionally milled, and loaded by the front boom, then mixed in the rear tank and the mix is finally unloaded. Sgariboldi machines provide: loading capacity, processing speed without compromising on mixing quality, and economy. These benefits are obtained with patented algorithms that enhance the overall operation of the machine, relieving the operator from stressful duties at the same time: automatic selection of the best cutting speeds and milling for each ingredient (Intelliloader machine), advanced mixing strategies (Intellimixer machine), optimum distribution of the food (if coupled with an optional, intelligent transmission), active suspension control for maximum traction on every ground, no matter how uneven it is.

## Self-propelled mixer-feeders

Titanium is a new generation of vertical self-propelled mixers of big volume, designed for all farmers who need to manage mixes with a high specific weight, with a machine that also offers loading performance and great maneuverability. A series of ultra-light machines because they are built with special alloys that allow enormous loads to be handled with only two axles, and combine the typical efficiency and durability of Sgariboldi mixers. Also designed to optimize loading times, it features the largest loading drum on the market: 2 200 mm width and 210 horse power. Combined with a loading arm 35 % wider, this makes the series unique in

its kind. The series is based on Epec's CAN-featured products.

The backbone of Sgariboldi machines consists of two CAN high-speed networks. The first one, running J1939, connects the electronically managed engine, a Topcon display, an Elobau Multifunctional Armrest – to safely (programmable logic controller) interface human driver and machine - and the Epec EC44 compact control unit, to control engine speed.

The second network uses the CANopen protocol as the vehicle backbone: the Epec EC44 control unit (commander) processes all the logic programmed with Codesys 3.5, extended by an Epec GL84 (responder) for the acquisition of all inputs, pressure, temperature, frequency and level sensors, and control of proportional valves. On the same network the display, CAN sensors for oil quality measurement, electronic suspension management and weighing system are also integrated, allowing a seamless interaction between all the elements of the machine.

The brain of the machine is the already-mentioned Epec EC44 control unit: due to its processor and Codesys 3.5, it is possible to implement complex control algorithms with ease and no fear of overloading. This is enabled even with a cycle time in the single-digit millisecond range, moving the boom and controlling the speed of all the



Figure 2: The EC44 has a 32-bit processor and large internal memory for application and parameters. It has 16 inputs and 16 outputs with high-side current measurement, two CAN networks, and a status LED. (Source: Epec)



Figure 3: The GL84 is for centralized control system architecture where one commander/central unit controls multiple responders. It has a whopping 27 GND pins for sensors and actuators and CAN1 is also routed to M12 connectors for wiring. (Source: Epec)

hydraulic actuators with precision. Its 16 inputs and 16 current-controlled outputs, each with extensive diagnostics, are packed in an IP69 aluminum case, that makes the machine builder able to place it with freedom, being confident that no vibration, shock, water, mud, dirt, or short-circuit will damage the unit. Top-notch CANopen support enables programming and responsive debugging directly on the vehicle backbone at 250 kbit/s, without feeling the need for an Ethernet port: sluggish performances of Codesys online interface because

of CAN communication are a thing of the past. And service personnel can update the unit via the display by a simple USB key, thanks to CiA 302-3 compliant software and firmware update procedure. CiA 302-3 CANopen additional application layer functions - Part 3: Configuration and program download, defines objects and file formats for the configuration manager and for program download and control.

The introduced EC44 is complemented by an Epec GL84 (responder) CANopen unit, built on the same architecture of EC44, thus sporting the same performances which make the engineer feel I/Os are on the commander control unit instead of being remote. Most of its outputs can be set up as current-controlled with an advanced algorithm, removing the need to close the loop in the commander control unit. Its case is as robust as the EC44 one, to withstand any conceivable abuse.

EC44 also manages the engine via J1939, directly or via the electronic transmission, using the Epec custom J1939 stack (Codesys one is nonetheless available). Sgariboldi developed the new control concept, which includes a revamp of the whole cabin and HMI (human-machine interface), in close cooperation with the engineers of Tritecnica, Epec Italian partner since 15 years, which developed all the software as a turn-key project. Ponsse Group technology company Epec is a system supplier specializing in advanced electrics/electronics for efficient, safe, and connected non-road mobile machines (NRMM) and commercial vehicles. Epec is a manufacturing company with extensive experience in control systems, customized products, electric vehicle systems and assistance, and autonomous systems. Since 1978, Epec's diverse experience is based on long term cooperation with leading international OEM's (original equipment manufacturer) in different sectors.

"Although our collaboration with Epec is quite recent, we immediately appreciated the quality of their hardware: well-made, reliable, and high-performance products. We are sure that it will be a really good partner also in the future," said Luca Sgariboldi, President of Sgariboldi.

Tritecnica concluded: "We love to raise the bar of performance and Epec controllers are the perfect mix of reliability and technology, as well as Luca Sgariboldi who is a practical but technology enthusiast. For us it's a pleasure and a challenge to be the bond between these companies". ◀

## CAN Newsletter Online

The CAN Newsletter Online as well as the magazine, already reported several times about CAN in agriculture and farming.



### CAN Newsletter magazine **History and trends: CAN in agriculture and farming**

The world human population is growing. CAN was helping, is helping, and will be helping to provide people with food and beverage.

[Read on](#)



### Agriculture milestone **Fully autonomous tractor**

At CES 2022, John Deere revealed the 8R autonomous tractor that is ready for large-scale production. The company uses CAN-based Isobus network(s) for interconnection of ECUs (electronic control unit) inside the tractor and between the tractor and implement.

[Read on](#)



### Farm robotics **Milking control unit with CANopen**

The MDS Saccomatic IDC by SAC (Denmark) is a milking control unit that communicates via CANopen. It was designed to create an easier workplace for milkers.

[Read on](#)

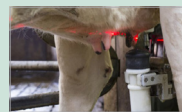

### Service robots **Cows decide when it's milking time**

The Boumatic (Netherlands) milking robots are equipped with CAN providing sensors from Sick (Germany). With those milking robots, cows can decide for themselves when they want to be milked.

[Read on](#)



### Expansion card **CAN solution for agricultural implements**

Farm cultivators attached to tractors require two CAN channels to operate. Innodisk's EMUC-B202-W1 embedded CAN expansion board, provides a solution without redesigning the mainboard by facilitating CAN communication through a MiniPCIe interface.

[Read on](#)



### Agritechnica 2022 **Award for CAN-based products**

Development engineers from the agricultural technology sector have selected the three winners of the Systems & Components Trophy – Engineers' Choice. CAN is part of these products.

[Read on](#)

## Author

Fabiana Gozzini  
Tritecnica/Epec  
[info@epec.fi](mailto:info@epec.fi)  
[www.epec.fi](http://www.epec.fi)



# One solution for complex CAN architectures

The Polish company DCD-Semi provides the DCAN FD IP core for implementation of standalone CAN (FD) controllers. The company's CAN-All ecosystem considers automotive safety standards and expands towards CAN XL.

In 1997 at a computer expo Bill Gates did say a joke: "If GM had kept up with technology like the computer industry has, we would be driving 25-\$ cars that got 1000 miles to the gallon". GM did not wait with a response saying that with the same car characteristics "your car would crash twice a day". 20 years ago, both statements built tensions between the automotive and computer industries. Nowadays we can see a different relationship between them. Every modern car is equipped with an on-board computer, multiple sensors, cameras, and safety systems. Lights, brakes, engine(s), even air-conditioning – all of these devices built in modern cars – are supervised by sensors and controlled by micro-controllers. And, this is where the CAN network is a vital part of (almost) every automotive being.

CAN was originally designed to significantly save on copper, because it did reduce the number of connections between devices, creating a global net inside the vehicle. Its story begins in the Robert Bosch company in 1983. By now it was further developed and standardized. In 2012, an improved version of CAN, the CAN with Flexible Data-Rate has been released to support greater loads without extending transmission time. Currently, another CAN successor is under development. CAN XL, supporting even greater loads and introducing new transmission features, such as PWM coding – seems to become "apple of daddy's eye" not only for automotive.

CAN did expand over the physical layer. Today when saying CAN, you may expect both hardware and software, covering the physical layer, data link layer, and application layer. More medium-dependent interface sub-layers may also be introduced. CAN is a complete environment, providing many standard mechanisms ensuring faster product development. The end-user may easily replace an old CAN controller without reinventing the design because the succeeding CAN protocols are all backward compatible.

## Automotive IP cores provider

DCD-Semi (Poland) masters automotive IP cores (e.g. DCAN FD) since 1999. That's why the CAN-ALL ecosystem is a natural step of development based on experience

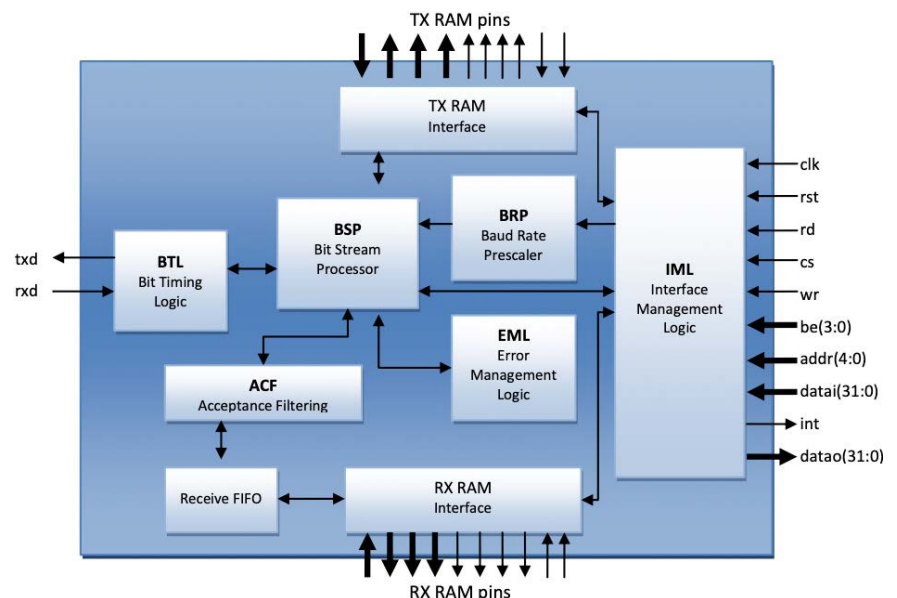

Figure 1: DCAN FD block diagram (Source: DCD-Semi)

gained with the biggest and the most innovative automotive companies. During these two decades the company developed more than 70 different architectures, which were successfully implemented in more than 750 000 000 electronic devices around the globe.

CAN-ALL is already proven in dozens of events and production designs. The verification is based, on more than two decades of market experience and thousands of automotive implementations with such companies as Volkswagen and Toyota.

The DCAN-FD IP core is designed in accordance with the ISO 11898-1:2015 standard. It does support CAN FD frames and the Classical CAN frames to provide backward compatibility. The IP supports up to 64-byte data frames. A CAN FD frame consists of the arbitration phase and the data phase. Between them, there is a dedicated BRS (bit rate switch) bit, which enables to increase the data bit rate while transferring payload. The bit rate switch takes place exactly between segment 1 and segment 2 of the BRS bit. This functionality is fully supported by the DCAN-FD. The data-phase bit rate may be up to 8 Mbit/s. The DCAN offers an advanced hardware frame filtering with multiple filter banks. To enable maximal throughput the IP can be equipped with multiple transmission buffers, so that the next CAN frames may be loaded while the current one is transmitted. The IP is also capable of receiving multiple frames inside the internal FIFO memory before reading them. This functionality might be also

used with a DMA (direct memory access) controller. All CAN frame types are supported: data frame, remote frame, error passive and error active frames, as well as the overload frame. For the transfer error detection and handling, the DCAN offers a sophisticated error management logic as a self-test capability. It can be both an active CAN participant and a listener. After multiple transmission errors and reaching of the error passive state, a device is cut-off from the network to avoid disturbance of the CAN traffic. To achieve a lower power consumption while CAN is in the idle state, the IP can be set to sleep mode and waked up, if a transfer occurs.

Additionally, the IP core offers many more features and can be tailored to the project needs, basing on customer's design requirements. The company's experience and the team spirit have led to creation of an advanced, fast, architecture-independent IP core design.

### Functional safety – 21<sup>st</sup> century approach to system design

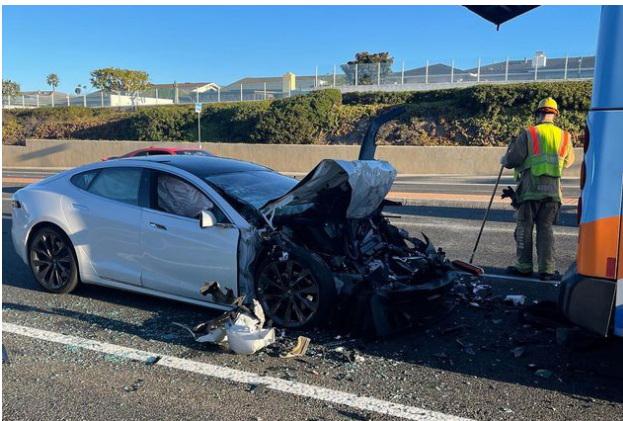

Figure: 2 Over the decades carmakers introduced a lot of measures to save lifes (Source: Autoweek.com)

Even the best engineer makes mistakes. Over the decades of car manufacturing (Benz Patent Motor Car, model no. 1 was reported in July 1886) did happen a lot. Many people died, but the lessons have been learned. The carmakers introduced hydraulic brakes for better deaccelerating, seat belts and airbags for better driver and passenger protection, lidars, cameras and blind-spot motors for the safety of all road users. Now, different introduced AI (artificial intelligence) applications should help the driver. Nowadays the manufacturers have to think about pedestrians' safety, too. The scope of the car-influenced elements expands pretty fast. In 1934 GM performed the first crash test to gain better real-life information about car safety. Vehicle safety standards evolved, and today's cars are safer than ever before. This wouldn't be possible without a tight cooperation between the automotive and electronics industry.

The biggest issue is that one cannot rely on the design itself. It can work as designed but still lead to an accident, because of the wrong design assumptions. A car can be stuffed with plenty of safety features, but their cooperation can fail. The vehicle can have advanced software supervising system, but the bad coding practices or compiler bugs can still lead to an unexpected behavior. ▷



USB-to-CAN FD  
for CAN and CAN FD

## PC/CAN Interfaces

Easy CAN and CAN FD connection  
for your application

- Interfaces for configuration, analyzing and control application as well as for the Ixxat tool suite
- All PC interface standards supported with one uniform driver – easy exchange without programming!
- Drivers (32/64 bit) for Windows7/8/10/11 and Linux
- APIs for CANopen and SAE J1939



Discover more:  
[www.all4CAN.com](http://www.all4CAN.com)



HMS Industrial Networks GmbH

Emmy-Noether-Str. 17 · 76131 Karlsruhe

+49 721 989777-000 · [info@hms-networks.de](mailto:info@hms-networks.de)

[www.hms-networks.com](http://www.hms-networks.com)



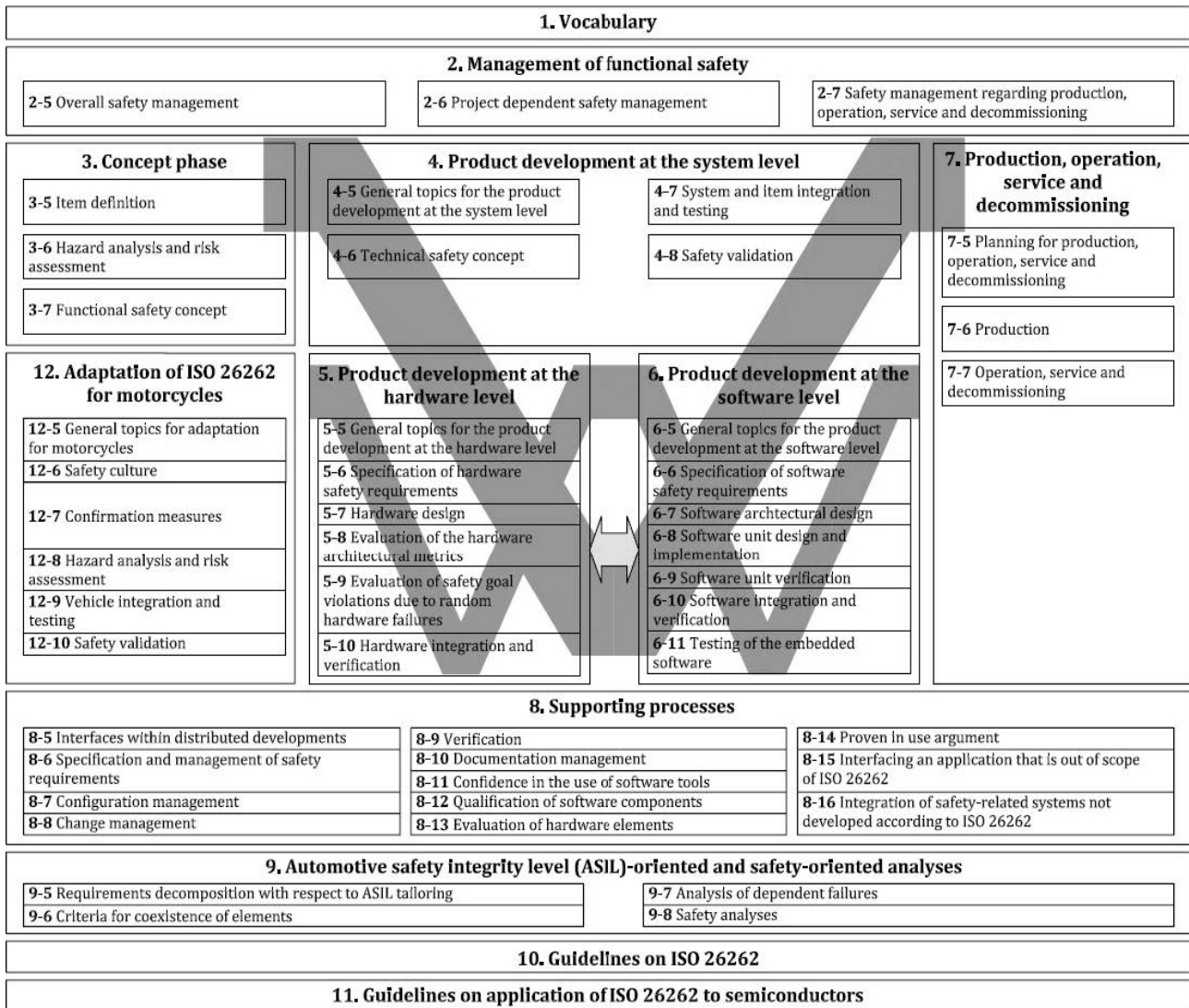

Figure 3: ISO 26262 standards overview (Source: ISO)

To change the whole conception, design, manufacturing, and decommissioning process (the product lifetime) the ISO 26262 standard has been introduced. The main goal is to mitigate risks (systematic failures and random hardware failures) by providing appropriate requirements and processes.

When trying to describe the standard in just one sentence – it ensures that the design is fully controlled at every step. Management is the key. Not only the design matters but also the project management. A project manager and competent, trained team members shall be drafted. Each product mastered within the project must be supervised: stored under a version control system, the author of each modification must be specified with the description of the change and date, the change must be reviewed by other team members. It is very important to establish best practices to be used in each project, specify the work products that need to be created, and plan each activity.

The project begins with the concept phase where proper safety goals must be defined. In the next step, proper functional safety concepts have to be defined to realize the safety goals. Then the proper functional safety requirements must be defined to realize the functional safety concepts. After that, the proper technical safety concepts must be defined to realize the functional

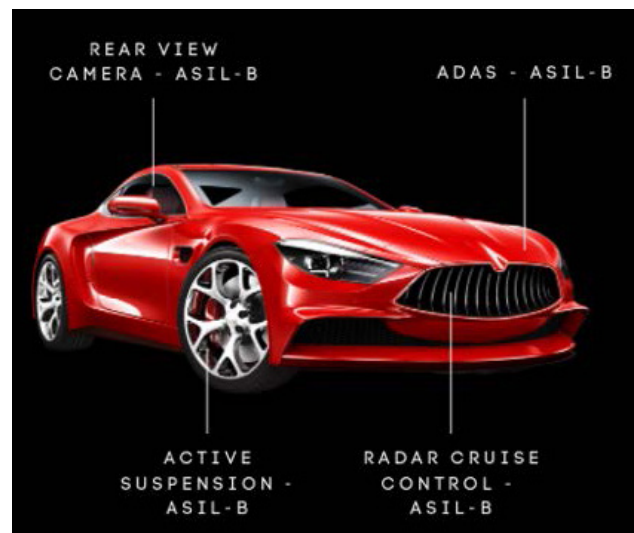

Figure 4: CAN-All fulfills the automotive safety requirements according to ISO-26262, ASIL-B (Source: DCD-Semi)

safety requirements. Then in the next step, proper technical safety requirements have to be defined to realize the technical safety concepts. The concepts and requirements are then used for the definition of safety mechanisms and assumptions of use, emphasized further in safety metrics >

calculation. Both hardware and software mechanisms are used to achieve the desired Automotive Safety Integrity Level (ASIL) defined by the obtained metrics: Single Point Fault Metrics (SPFM) and Latent Fault Metrics (LFM). The standard determines the necessary testing and verification procedures. Further steps include production, operation, service, and decommissioning, supporting processes, and safety analyses.

The DCAN is developed as an ISO 26262 Safety Element out of context (SEooC). The SEooC (DCAN is a soft IP SEooC) is an element developed and analyzed in an assumed context of use, e.g. target FPGA board, memory used, etc. The SEooC is delivered with the complete ISO26262 required documentation. The system integrator must reevaluate the safety analysis based on the target system and the safety analysis of other system elements. The SEooC provides a deep knowledge about the DCAN IP, its failure modes, safety mechanisms that enable to reach the required ASIL level, complete Failure Modes Effects and Detection Analysis (FMEDA) with step-by-step instruction to help to integrate the IP into the customer's system and to conduct the system-level safety analysis. The conducted safety analysis depicts, that the safety metrics is fulfilled and IP reaches the ASIL-B level (SPFM > 90 %, LFM > 60 %). The goal of creating an SEooC is to shorten the product time to market. Thus, the system integrator does not need to know in detail the SEooCs used in the system, but still can calculate the system safety metrics and gets instructions on the

SEooC usage and integration. It should be mentioned that the SEooC designer has a better overview of the design and can perform the element's safety analysis much faster and better.

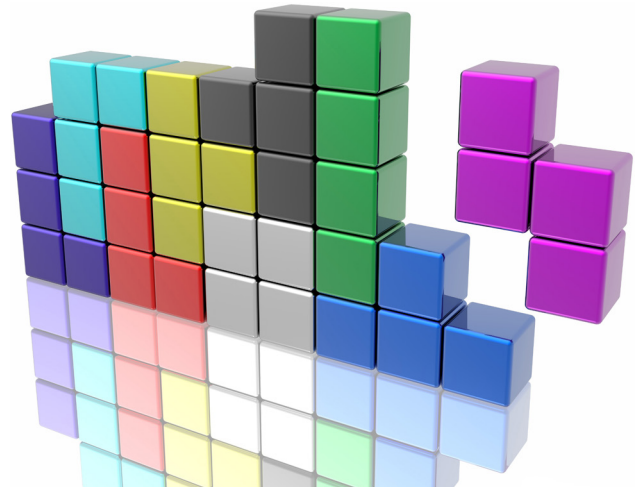

Figure 5: To replace a block in a modular system should be as simple as to play Tetris (Source: Adobe Stock)

### CAN stack – modularity is a must

Modularity is a must in these days. Why? It's more than obvious: The engineer replaces a deprecated element (e.g. a Classical CAN controller) with a newer one (supporting CAN FD), instead of building a new design from scratch. ▶

# CANopen Miniature Pressure Transmitter CMP 8270

- Different accuracy classes i. e. 0.1 % FS typ
- Measurement of pressure and temperature
- CANopen DS301/DS404, supports CAN 2.0A/B



[www.trafag.com/H72614](http://www.trafag.com/H72614)

**trafag**  
sensors  controls

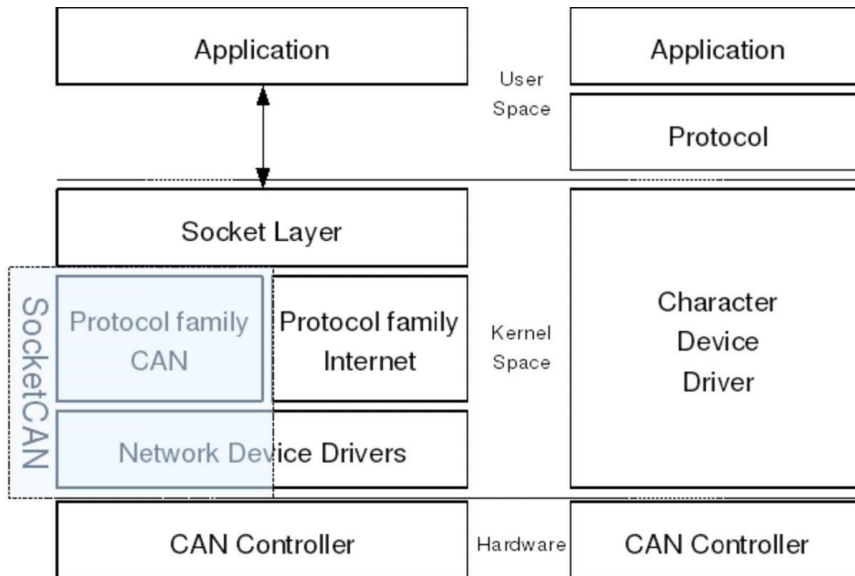

Figure 6: SocketCAN Linux driver (Source: SocketCAN public domain)

As far as the physical layer is concerned, it is backward compatible, but what if the design has a ready application layer? The DCAN driver enables access to the device and can be easily integrated with an existing CAN stack e.g. CANopen or even with Autosar. This stack might also be used with an already existing application. So, combining all the standard elements with standard interfaces in one design, the replacement of one block by another block offering the same functionality, but a newer or faster one, should be as simple as replacing a Tetris block with a different block (let us assume with a different color) but with the same shape.

### SocketCAN - DCAN meets Linux

A good modularity example is the use of the Linux CAN API. SocketCAN is the official CAN API of the Linux kernel. Each Linux user-space application is developed independently from the underlying hardware. The Linux OS (operating system) offers a set of mechanisms to connect a user-space application with a kernel module. The kernel module (also called a Linux driver) is responsible for the hardware management, configuration, as well as data transmission and reception. For example, if the application needs to use the can0 device, the OS invokes the module can0 and every access is forwarded to it.

SocketCAN is the driver and the networking stack created by Volkswagen Research. It is an open-source project and takes the most opportunities from a network interface. It is not limited to the previous character device implementations. It uses the Berkeley socket API, so the use of a device is as easy as opening a socket and writing to it. The abstraction level is maintained, and the device driver benefits from the existing queuing functionality. The SocketCAN API is very similar to a typical TCP/IP layer model. The similarity to network programming is the key for programmers and saves time on learning how to use a CAN device.

Just to mention, that the available on-market CAN-FD stacks are built upon an existing CAN driver and are OS-independent, so the SocketCAN can be easily integrated into them.

### CAN XL – future is coming

Controller Area Network Extra Long (CAN XL) is the upcoming third generation of the CAN data link layer. The modern, high-accuracy sensors, etc. need to transmit large data packets to the micro-controller. That is why the new CAN generation offers up to 2-KiB data packet transmission. Also, transmission speed is about to increase – large packets need to be sent faster, not blocking the network. The additional PWM (pulse width modulation) coding in CAN XL allows bit rates of 10 Mbit/s or higher. I would be more than happy to provide you more details of the latest DCD's CAN XL solution, but as the working mode is “prog-

ress”, my colleagues could do me harm... That's why let's wait for a while, I believe that [CiA's anniversary party](#) would be a good chance to share more details. The IP itself will be more secure, faster, and optimized, but still based on the best experience collected while developing DCAN and DCAN-FD. ◀



#### Author

Robert Nawrath  
DCD-Semi  
[robert.nawrath@dcd.pl](mailto:robert.nawrath@dcd.pl)  
[www.dcd-semi.com](http://www.dcd-semi.com)



**IFD Intensive Fieldbus Diagnostic –**  
*Detect faults before they occur at all.*

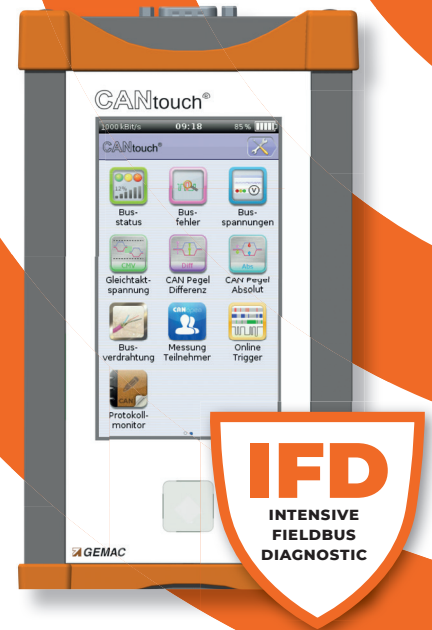

**Safe in every situation.**

**GEMAC**

[gemac-chemnitz.com](http://gemac-chemnitz.com)



**POWER  
IMU**



**GEMAC Motus® –**  
*The FIRST POWER-IMU for Mobile POWER-Machines.*

## Extending the CAN network

To overcome CAN limitations, Marin successfully used the TCS-10 CAN switch from TK Engineering to split the CAN network into segments. This gave them the option to have a longer CAN, higher data rates, more flexible network topology and resistance to faults in the CAN network. A case study.



Figure 1: Test of ship models which are controlled by CAN-connected servo drives (Source: Marin)

When Maritime Research Institute Netherlands built larger and more complex simulations and test facilities, they realized that they were limited by the size of the CAN network and by the length and speed of the CAN used to control the test equipment. To overcome these limitations, Marin successfully used the TCS-10 CAN switch from TK Engineering to split the CAN network into segments. This gave them the option to have a longer CAN, higher data rates, more flexible network topology, and resistance to faults in the CAN network.

### Ship models controlled by CAN-connected servo drives

Many Marin model tests are performed with electrical servo-powered ship models. In the most simple setup, for example a propulsion test, this involves only a propeller. Maneuvering and free sailing requires additional rudder servo motors. Other actuators such as fins, tunnel thrusters, winches, and podded propulsors are used as well,

most of the time combined together. These servo drives and motors are typically developed by Marin itself to offer the best solution for a test. Most of the time of this equipment must be waterproof, it must have very little backlash but it also must be flexible to (de-)mount in any unique ship model.

The servo motors in the ship models are controlled by a software algorithm (auto pilot). This software algorithm provides set points for the propeller rpm and rudder angles based on the motions and position of the model. Position is measured by a 3D infrared camera system; motions are either a derivative or in most cases measured by a rate gyro. Each signal is recorded and handled by a PC running the auto pilot. The resulting set points are transferred via OPC to Marin software called BSS (Basic Steering System). BSS acts as an interface between the auto pilot and CAN. CAN is the Marin standard serial bus system for addressing servo drives. It gives us the advantage of a robust, high-speed bus system, which can be used over greater lengths in a rugged environment. ▶



Figure 2: Test of wind turbine models (Source: Marin)

## Pushing the limits of CAN

When CAN was first introduced at Marin in 1999, ship models were not as complex as they are today. Generally, throughout the last decade, an increase in actuators and desired bus speed can be seen. Today, models with 16 fast actuating servo motors are no exception in for example an offshore rig. This increased number of servo drives (or CAN nodes), and also the higher software processing speeds, required a higher bandwidth CAN to the point that the bandwidth of the CAN is becoming a bottleneck.

In Marin's offshore basin both waves and wind can be generated. To simulate the latter, wind fans are used. These are all servo motor equipped fans with an integrated servo drive connected to CAN. This is where problems first arose. In order to create a homogeneous wind field, a battery with up to 55 wind fan servos can be used. In a model test a wind spectrum can be applied. This results in a dynamic wind field with for example sudden gusts as it would be in real life. Therefore, all wind fan servos continuously receive new set points.

In the past, all wind fan servos were connected to one long CAN network, with a PC acting as commander. In this setup the network load became critically high, sometimes over the edge of what is allowed. To further complicate things, if one servo drive would fail, as a result the entire network would fail, ultimately resulting in a complete breakdown. During a model test these breakdowns would create a lot of extra time pressure and costs. Other facilities also suffered from the high demands in performance, network load problems with free sailing models, but also distance vs. maximum bit rates (with 125 kbit/s as the Marin standard).

## More flexibility was needed for CAN

With CAN being a daisy chain, until recently there was no other option than connect one drive to another, with a terminator at the very beginning- and end of the network. This affected flexibility (which for Marin is very important with a changing setup for every test). In case of network load problems there was little more to do than lowering the network bit rate but this inconveniently interferes with the model test. In some cases, there even was an additional PC placed with its own CAN network and software couplings to rel-



Figure 3: CAN-connected fans are used to create wind for tests (Source: Marin)

evant Marin systems as a quick fix. This however is very complex and time-consuming. In general, CAN at Marin provided a lot of possibilities, but as time went by the increasing demands left the system with room for improvement.

## Using a switch to split CAN into segments

The solution was using the TKE CAN TCS-10 switch to split CAN into segments. Marin first learned from the switch entering the market in 2015. The product did seem to offer an ideal solution for the problems we were facing. At that very moment a large overhaul of the Offshore Basin was already in the planning, so a CAN upgrade could very well be combined with this overhaul. The units were provided by the Dutch supplier Jonat Automation, and were first bor- ▶

### About Marin

Maritime Research Institute Netherlands is a provider of advanced expertise and independent research. Through the use of the newest test facilities, full-scale measurement and simulators, and working together with an extensive innovation and research network we achieve our goal: the development of cleaner, safer, and smarter ships and sustainable use of the sea. Marin is based in Wageningen and employs a staff of 400.

### About TK Engineering

TK Engineering provides expert services related to CAN technology. TK Engineering works together with the market leaders in the marine, rail, machinery, heavy vehicles, and defence industries to design CAN hardware and software and combine them with various technological systems.

### About Jonat Automation

Jonat Automation provides engineering and consultancy services for industrial automation projects, specializing in CAN and machine vision. Jonat Automation is a distributor of TK Engineering's products in the Netherlands.

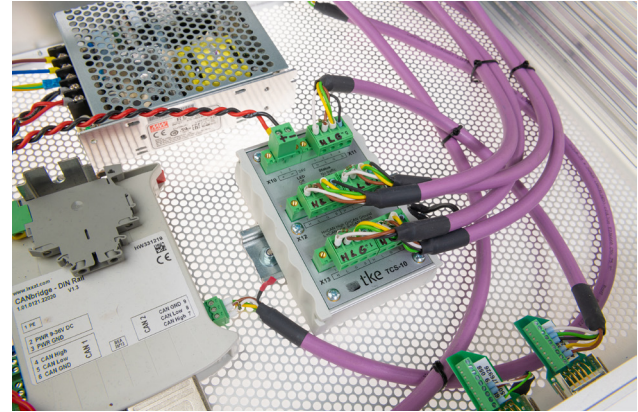

Figure 4 + Figure 5: The TCS-10 CAN switch mounted into a 19-inch rack. These racks are installed in the test basins to accommodate all CAN hardware. (Source: Marin)

rowed to do some thoroughly testing. After this, a design was made and was implemented in the CAN network infrastructure in the basin.

The units were first applied at the wind fans. A CAN switch has four ports. Instead of daisy chaining the bus over all fans, the computer (which is about 100 meters away) was connected to one port of the switch. The other three ports were equally divided over the wind battery with each a number of fans. This resulted in a tree-topology with the PC in the root. Port forwarding was applied. Each wind fan section forwards to the root (PC), but not to other sections. In this way, CAN messages are filtered and do not disturb other sections.

This approach reduces the bus load at the wind fans, but introduces the risk of congestion in the root as well. After all the PC still has to handle all 55 fans. To avoid this the bit rate in the root was increased. The TKE CAN switch can also act as buffer between different bit rates, so locally the Marin standard bit rate of 125 kbit/s is retained. By setting the root to 250 kbit/s, the switch enables this section to handle more traffic.

In the end, the switch provided us with a setup with several field connections. Additional benefits are that

in case of any problem, this is limited to the section where it occurs (and not the whole wind system). It was observed that a switch port with a forced error frame percentage of 100 %, did not affect operation on the other ports. This makes troubleshooting much easier and less time-consuming.

The table below shows some basin test results from the commissioning report. Port 1 is the PC/Commander and root. Port 2, 3, and 4 had several servo drives connected. This table clearly shows the advantage of using a port-forwarding switch rather than daisy chaining all nodes on one long network.

Note that these tests were not performed with the entire 55-fan battery active, but only a few per section. The table only illustrates the performance that can be achieved by applying a TKE CAN TCS-10 switch.

This being a success, more switches were applied. On the bottom of the root another switch was placed to provide for extra field connection points. These are situated right across the basin and are used for winches. Some customers prefer applying a wind force on their model by roped winch rather than an actual wind flow. Both systems are not used simultaneously but could be in theory. In the

Test condition	Bus load CAN #1	Bus load CAN #2	Bus load CAN #3	Bus load CAN #4
All ports 125 kbit/s, no port forwarding (switch acting as a HUB) <i>Although in terms of bus load the switch might seem useless here, there still is an advantage in the fact that the switch can still filter any error message, improving operation.</i>	19 %	19 %	19 %	19 %
All ports 125 kbit/s, forwarding #3 only to #1 <i>Notice the drop in bus load on #2 and #4, which do not have to cope with the #3 CAN frames anymore.</i>	19 %	14 %	19 %	14 %
All ports 125 kbit/s, forwarding #3 only to #1, with some forced extra bus load <i>The bus load reduction on #2 and #4 is here even more visible</i>	28 %	15 %	28 %	15 %
All ports 125 kbit/s, forwarding #2, #3, #4 only to #1 <i>Now the #2, #3 #4 bus load are not affected anymore by each other. Only #1 has to process all the frames.</i>	23 %	9 %	9 %	9 %
Bit rate #1 increased to 500 kbit/s, others 125 kbit/s, forwarding 2, 3, 4 only to #1 <i>Tunnelling the #2, #3 and #4 frames to a higher speed decreases the #1 bus load as well.</i>	5 %	9 %	8 %	8 %



Figure 6: The TCS-10 CAN switch offers the possibility of using a great number of CAN nodes (Source: Marin)

past a manual switch had to be set, choosing between 'winch' or 'wind'. By inserting a switch this combines the two systems and error chances are reduced.

On the carriages, switches were applied to provide us several field connection points divided over different places on the carriage. In this way ergonomics benefited; our ever-changing models and test setups asked for flexibility in connection points, and this also reduced the desired cable length, reducing the failure chances even more.

Ever since the TKE CAN switch was applied at Marin, no more CAN-related errors occurred in the test facilities, reducing the downtime to zero. Concluding it can be stated

that the CAN switch offers the possibility of using a great number of CAN nodes, it simplifies the setup and improves flexibility. After the Offshore Basin overhaul, the Seakeeping and Maneuvering Basin followed. Currently a proposal for upgrading the CAN topology in other test facilities has already been approved and is awaiting a maintenance stop during which all new hardware can be installed. ◀

#### Authors



Bas Flipse  
Marin  
[info@marin.nl](mailto:info@marin.nl)  
[www.marin.nl](http://www.marin.nl)

Simon Byholm  
TK Engineering  
[info@tke.fi](mailto:info@tke.fi)  
[www.tke.fi](http://www.tke.fi)



## Get the CAN-related knowledge!

### Online seminars

	Date	Language
CAN	2022-09-27	English
CANopen	2022-09-28	English
CAN for newcomers	2022-10-12	Nuremberg
CANopen for newcomers	2022-10-13	Nuremberg
CAN	2022-11-30	English
CANopen	2022-12-01	English

### Onsite seminars

	Date	Language
CAN	2022-10-12	German
CANopen	2022-10-13	German

Subject to change without notice.

### CiA in-house seminars online

CiA engineers discuss your urgent CAN-related issues that are currently of high interest with regard to your projects.

*For more details, please contact CiA  
office: [events@can-cia.org](mailto:events@can-cia.org)  
[www.can-cia.org](http://www.can-cia.org)*

## Measurement and calibration tool

The Diagra X Windows software from RA Consulting provides a solution for measurement and calibration tasks using Classical CAN, CAN FD, CCP, XCP, and other protocols. The company introduces this and further CAN products.

RA Consulting, headquartered in the asparagus town of Bruchsal, Germany, develops software inspired by people. The IT service provider and tool specialist comes with measurement, calibration, and diagnostic know-how for the automotive industry offering over 30 years of experience through intensive development. The products are used by more than 400 customers worldwide with over 40 000 active licenses in the market. RA Consulting has a global presence with regional offices in Beijing, Detroit and more than 13 sales partners in Europe, North America, and Asia. In 2022, RA Consulting joined CAN in Automation (CiA) as a member.

Generations of RA tools are supporting CAN-based protocols such as Classical CAN, CAN FD, CCP, and XCP, and are scalable to CAN XL and beyond. In addition, they support many other protocols used in the automotive industry. RA tools are modular and are highly-scalable to the latest technological trends and individual needs of customers. Some of the well-known tools includes Diagra D, a specialized diagnostic software providing complete solution for vehicular diagnostic development. Diagra D offers reliable diagnostic functions for the acquisition of high-quality diagnostic data from vehicle ECUs (electronic control unit). It supports Classical CAN, CAN FD, SAE J1939, SAE J1979, and others.

Silver Scan-Tool focuses on 100 % OBD compliance for OBD-II, EBOD, HD OBD, and WWH OBD diagnostics around the world including J1939 and J1979. We offer many other software tools, components, and services to our customers worldwide. Diagra Flash Station is a flashing tool which lets users flash up to 20 control units on separate Classical CAN or CAN FD vehicle networks. In the case of DoIP, the control devices can be operated together in a subnet.

### Measurement and calibration tool

Diagra X, a relatively young and modern tool for measurement and calibration tasks with focus on usability joins the RA tools family. Measuring and calibrating ECUs is a complex process, due to frequent changes in ECU software and short time-to-market, poses a great challenge for application engineers to optimally adjust software parameters for the given configuration of the system. Although there are many tools for measurement and calibration tasks on the market, Diagra X stands out for its function-oriented, data-rich, and user-friendly design. Diagra X is developed in compliance with ASAM standards and func-



Figure 1: Diagra X 1.11 (Source: RA Consulting, AB Graphic)

tional safety is ensured in accordance with ISO 26262. The tool is not limited to automotive applications. Its design and configurable architecture allow it to be used in other application areas using Classical CAN, CAN FD, CCP, and XCP on CAN.

### Plug-and-play source connectivity

In a larger project with multiple model variants and multiple stakeholders from different areas such as development, calibration, and validation, there is often the possibility that many different control software and interface hardware being used from different vendors. In such scenarios many of the times setting-up of tool environment and associated hardware interfaces is too cumbersome and confusing to novices. Diagra X's plug-and-play source connectivity and compatibility with a range of interface hardware makes it easier for users to create and share configura-



Automotive

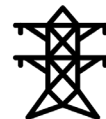

Power Utilities



Agriculture



Industry



Sea Vehicles



Railway

Figure 2: Diagra X application areas (Source: RA Consulting)

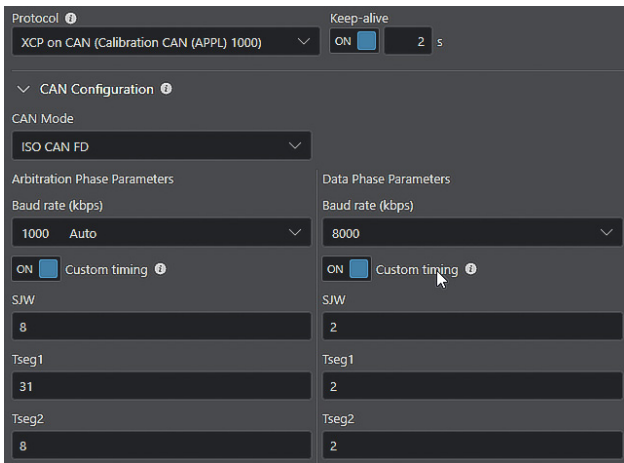

Figure 3: CAN configuration in Diagra X (Source: RA Consulting)

tions. The product automatically detects the supported protocols based on the source description files such as A2L, DBC. Today, vehicles are equipped with many ECUs, each of which may have thousands of signals to measure and characteristics to optimize. In many cases, users need to tune these ECUs in parallel to achieve optimal vehicle performance.

The Diagra X architecture supports multiple controllers in parallel for measurement and calibration operations, users can also use multiple working pages for each controller. The tool offers a variety of configurable visualizers that are well-suited for low to high-speed, high-performance tasks.

### Reusable architecture

Typical users of an MCD tool create an experiment consisting of multiple visualizers to perform measurement and calibration operations. In traditional tools, these visualizers are loosely aligned and can be freely moved around the computer screen. As the number of visualizers increases, it often becomes difficult for the users to find and keep track of the visualizers and variables. Diagra X addresses this typical user pain-point with its grid-based layout of

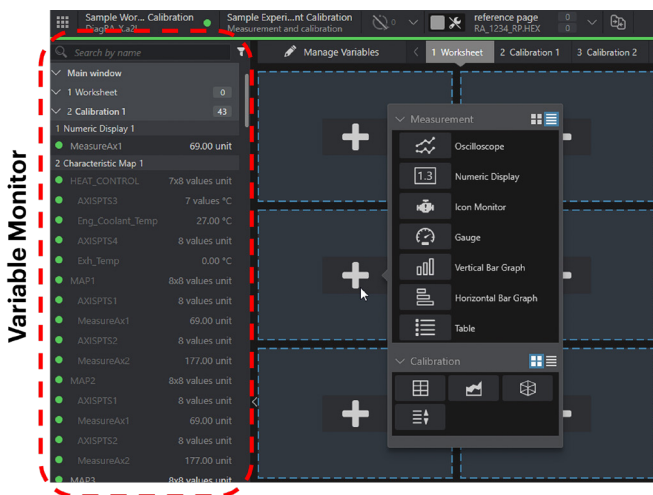
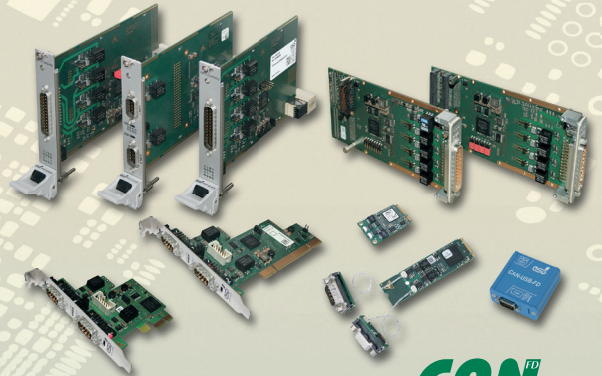

Figure 4: Grid layout of a worksheet and the variable monitor (Source: RA Consulting)



[www.esd.eu](http://www.esd.eu)

All you CAN plug



CANopen<sup>FD</sup>

CAN<sup>FD</sup>

## CAN / CAN FD Interfaces

### Product Line 402 with Highspeed FPGA

- **Various Form Factors**  
PCI, M.2, PCI Express® Mini, PCI Express®, CompactPCI®, CompactPCI® serial, XMC and PMC, USB, etc.
- **Highspeed FPGA Design**  
esdACC: most modern FPGA CAN-Controller for up to 4 channels with DMA
- **Protocol Stacks**  
CANopen®, J1939 and ARINC 825
- **Software Driver Support**  
Windows®, Linux®, optional Realtime OS: QNX®, RTX, VxWorks®, etc.



**esd electronics gmbh**  
Vahrenwalder Straße 207  
D-30165 Hannover  
Tel.: +49(0)511 372 98-0  
info@esd.eu | www.esd.eu



**esd electronics, Inc.**  
70 Federal Street - Suite #2  
Greenfield, MA 01301  
Phone: 413-772-3170  
www.esd-electronics.us

## CAN Newsletter Online: Tools

The CAN Newsletter Online, continuously informs about various CAN-based tools:



### Oscilloscope *CAN XL decoder software*

Keysight Technologies has introduced the D9010AUTP software package for its Infiniium oscilloscopes. Besides other automotive network protocols it can trigger and decode CAN XL frames.

[Read on](#)



### CAN Newsletter magazine *Improving automotive CAN diagnostics*

As automotive CAN FD networks are proliferating throughout today's road vehicles, it is important to diagnose, if there is a fault on the CAN lines.

[Read on](#)



### Internet of Things *Cloud solution for CAN networks*

The Cloudcommander from Odos combines the CAN-to-USB converter from Kvaser, the Leaf Light HS V2, with the IoT cloud platform from Odos to offer a complete CAN-to-cloud data monitoring and data-logging solution.

[Read on](#)



### CAN tools and background *CAN data streaming and electronic CAN guide*

CSS Electronics recently enabled its CANmod sensor-to-CAN modules to stream acquired data in real-time. It also added online tools for OBD-II, J1939, and CAN FD to its portfolio. Further, the company introduced a 100-page CAN guide as PDF.

[Read on](#)



### Tire Technology Expo 2022 *Showcasing hydraulic and filtration products*

Parker Hannifin, provider in motion and control technologies, will show products to the tire industry. The Service Master Connect diagnostic measuring device can compile, store, monitor, and evaluate CAN data. It can be connected to CAN, CANopen, and J1939.

[Read on](#)



### PCIM Europe 2022 *Test solutions for power electronics*

At the PCIM Europe 2022 in Nuremberg, Germany, Rohde & Schwarz demonstrated its latest test solutions for developers of power supplies and other power electronics.

[Read on](#)

worksheets and well-organized experiments. The users can assign a measurement or a calibration visualizer to a grid or a set of grids, these assigned visualizers are fixed in that worksheet. The users could easily search and find worksheets, visualizers, and variables using the variable monitor.

## Connectivity to automation systems

Product development encompasses many known scenarios and workflows, but also many unknown scenarios and failures. For the known scenarios and workflows, the users can optimize the measurement and calibration effort by design of experiments and intelligently automating the measurement and calibration process. For example, the users can define a calibration approach to optimize sweet points instead of calibrating a complete map. Diagra X supports remote control by an automation system, such as a testbench, via the ASAP3 and ASAM MCD-3 MC protocol.

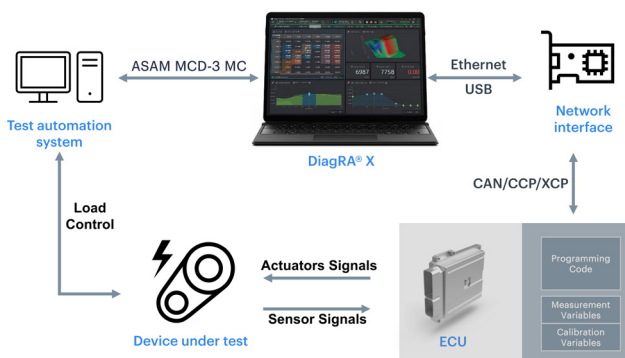

Figure 5: Remote control of Diagra X using ASAM MCD-3 MC (Source: RA Consulting)

## Triggers and action management

For recording and analysis of random scenarios and faults, the tool offers several unique features, such as "Event Setup", which allows the users to define a set of recorders to be triggered by independent events. "Snapshot" is another interesting feature that allows the user to record last 1 minutes of measurement data with click of a button, this helps to avoid large amounts of unwanted data being recorded during analysis or reproduction of random failure scenarios.

Controller calibration can be a safety-critical operation, where user needs to be conscious of the calibration impact. Diagra X supports both online and offline calibration with smart and safe calibration visualizers, which offers calibration in Table, Matrix, and 2D map view with clear visibility of applied values, operating point, changes in relation to the reference page and many other options.

## Calibration data management

In the initial phase of a project, users typically start by calibrating an ECU using the base dataset from an existing similar system. Diagra X offers the "Compare Pages" function, an easy-to-use, integrated calibration data manager that enables management of dataset configurations in .hex, .s19 and .dcm file formats. After performing intensive calibration operation, one definitely needs to have an overview of changes, "Compare Pages" offers online comparison of reference and working page, also one could import and export calibration data. For extended dataset management, the IAV MACARA tool can be used in combination with Diagra X.



To protect the ECU software know-how and calibration data, each manufacturer uses various techniques to prevent access to the ECU software and its subsequent adaptation in the aftermarket. Diagra X supports secured access to an ECU such as seed and key based mechanism, cross-check of code and data segment.

Diagra X offers flash programming of ECUs via CCP and XCP as state-of-the-art, with an add-on software users can even perform custom UDS flashing. This UDS add-on allows users to configure the flash process graphically without programming knowledge. The configured flash process can be used encrypted, Classical CAN and CAN FD are supported.

### Data analysis with Diagra X Viewer

Diagra X records the measurement data in the ASAM standard file format ASAM MDF(.mf4). During online measurement, users can perform various operations on the measured signals, such as fast statistical evaluation, computation of virtual or calculated variables, trace analysis. The software includes an additional viewer tool "X Viewer" to visualize the measurement file, this enables users to analyze their measurement data. Users can launch X Viewer as a stand-alone tool or directly from Diagra X environment.

X Viewer offers structured configurations, wherein users can define their own visualization configurations, the measurement file from Diagra X environment can be directly opened in the desired pre-defined X Viewer configuration. Users can perform data analysis in X Viewer using various visualizers, stacked view of oscilloscope, various types of cursors, statistical functions, built-in library functions, and define custom analysis using virtual variables.

In summary, Diagra X is a modern, state-of-the-art software that offers excellent usability and efficiency in measurement, calibration, and flashing tasks using CAN, CAN FD, CCP, XCP and many other protocols. ◀



#### Author

Hanamant Hirekurbar  
RA Consulting  
[info@rac.de](mailto:info@rac.de)  
[www.rac.de](http://www.rac.de)



# Back again!

We appreciate being able to offer you CANopen product panels, again.

After two years of virtual meetings only, promote your CAN-related products onsite, at the following trade shows:

- ◆ Bauma, October 24 to 30, 2022, Munich
- ◆ SPS, November 08 to 10, 2022, Nuremberg

*For booking CANopen product panels, please contact: [exhibition@can-cia.org](mailto:exhibition@can-cia.org)*

**[www.can-cia.org](http://www.can-cia.org)**



The non-profit CiA organization promotes Classical CAN, CAN FD, and CAN XL, develops CAN FD recommendations as well as CANopen-related specifications, and supports other higher-layer protocols such as J1939-based approaches.

## *Join the community!*

- ▶ Initiate and influence CiA specifications
- ▶ Get credits on CiA training and education events
- ▶ Download CiA specifications, already in work draft status
- ▶ Get credits on CiA publication advertisements
- ▶ Receive the monthly CiA Member News email service
- ▶ Get the CANopen vendor-ID free of charge
- ▶ Participate in plugfests and workshops
- ▶ Get the classic CANopen conformance test tool
- ▶ Participate in joint marketing activities
- ▶ Develop partnerships with other CiA members
- ▶ Get credits on CiA testing services

CAN in Automation e. V.  
Kontumazgarten 3  
DE-90429 Nuremberg

[headquarters@can-cia.org](mailto:headquarters@can-cia.org)  
[www.can-cia.org](http://www.can-cia.org)