

March 2020

# CAN Newsletter

*Hardware + Software + Tools + Engineering*



*CAN FD system  
design challenges*

*Challenges for wiring  
harness development*

*Physical layer*

[www.can-newsletter.org](http://www.can-newsletter.org)



# Six-Channel CAN FD Router

## ■ PCAN-Router Pro FD

New Programmable 6-Channel Router and Data Logger for CAN and CAN FD

The PCAN-Router Pro FD links the data traffic of up to six modern CAN FD and classic CAN buses. This allows the conversion from CAN to CAN FD or vice versa and therefore, the integration of new CAN FD applications into existing CAN 2.0 networks. In addition, the CAN messages can be recorded on the internal memory or on an inserted SD card.

The PCAN-Router Pro FD can be programmed freely for specific applications. The firmware is created using the included development package with GNU compiler for C and C++ and is then transferred to the module via CAN. Various programming examples, such as message forwarding or recording, facilitate the implementation of own solutions.

### Specifications:

- STM32F765NIH6 microcontroller (based on Arm Cortex M7)
- 32 MByte SDRAM in addition to microcontroller RAM
- 6 High-speed CAN channels (ISO 11898-2)
  - Comply with CAN specifications 2.0 A/B and FD
  - CAN bit rates from 40 kbit/s up to 1 Mbit/s
  - CAN FD bit rates from 40 kbit/s up to 12 Mbit/s
  - NXP TJA1043 CAN transceiver with wake-up
  - Alternative pluggable transceiver modules on request
  - CAN termination switchable, separately for each channel
  - CAN connections are D-Sub, 9-pin

- I/O functionality
  - 4 digital I/Os, usable as digital input or output (2 with High-side and 2 with Low-side switch)
  - 1 analog input (0 - 33 V)
- Recording of CAN data and error frames
- Internal memory: 16 GByte eMMC
- SD card slot for additional memory
- USB connection for accessing the data memory (e.g. recorded log data)
- Conversion of logging data to various output formats using a Windows software
- Wake-up function using separate input, CAN bus, or real-time clock
- Power supply 8 - 32 V with protection against overvoltage and reverse polarity
- Slot for a backup battery for defined switch-off behavior (e.g. for log data saving)
- Extended operating temperature range from -40 to 85 °C (-40 to 185 °F)
- Aluminum casing with flange
- Optional on request:
  - Ethernet interface via RJ-45 socket or BroadR-Reach® interface via D-Sub connector



## Physical layer

CAN FD system design challenges	4
Challenges for wiring harness development	14

## Imprint

### Publisher

CAN in Automation GmbH  
Kontumazgarten 3  
DE-90429 Nuremberg

[publications@can-cia.org](mailto:publications@can-cia.org)  
[www.can-cia.org](http://www.can-cia.org)

Tel.: +49-911-928819-0  
Fax: +49-911-928819-79

### CEO

Reiner Zitzmann

AG Nürnberg 24338

### Downloads December issue:

(retrieved February 17, 2020)  
2962 full magazine

### Editors

Olga Fischer (of)  
Cindy Weissmueller (cw)  
Holger Zeltwanger (hz)  
(responsible according  
to the press law)  
[pr@can-cia.org](mailto:pr@can-cia.org)

### Layout

Nickel Plankermann

### Media consultant

Meng Xie-Buchert  
(responsible according  
to the press law)  
Rosanna Rybin

### Distribution manager

Rosanna Rybin

### © Copyright

CAN in Automation GmbH



## System design

The first CAN networks in BMW cars	20
Best in test	22

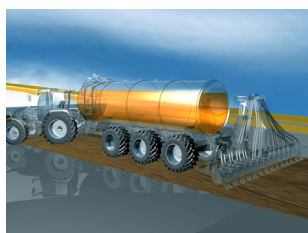

## Device design

Scalability of CANopen	26
Don't design - configure!	28
Sensor fusion: Inertial measurement units	32



## Availability of CAN FD building blocks

The [Embedded World 2020](#) trade show takes place in Nuremberg (Germany) from February 25 to 27. CAN in Automation (CiA) has a booth in hall 1 (stand 630).

This year's main topic on the CiA stand is the availability of CAN FD building blocks. This includes CAN FD controllers, transceivers supporting bit-rates above 1 Mbit/s, higher-layer protocols using the 64-byte data field, and CANopen FD protocol stacks. Device designers can select interoperable products from different suppliers.

CAN FD provides an accelerated firmware update with up to 5 Mbit/s in the data transmission phase. It also enables smart security measures with 64 byte max. payload, as well as simplified functional safety. CAN FD provides dynamic cross-communication supported by CANopen FD and reduces the bus-load for J1939. As usual, CiA shows classic CANopen products on its stand.

# CAN FD system design challenges

Which technical concepts behind make CAN FD communication robust and how are CAN SIC (signal improvement capability) transceivers changing the possibilities for CAN FD networks?

In our [previous article on CAN signal improvement](#), the fundamentals of the CiA 601-4 specification were reviewed, and its impact on the potential of CAN FD networks. In this article, we explore in more detail some of the technical concepts behind what makes CAN FD communication robust and how CAN SIC transceivers are changing the possibilities for CAN FD networks.

In order to define the challenges of CAN network design, one of the first points to address is how one determines what a “good” or robust network design is. When working with network architects, we start from the fundamental theory of Classical CAN and CAN FD. There is a dominant level, which is defined as a differential voltage measure above 0,9 V, and a recessive level, defined as a differential voltage below 0,5 V. This is valid irrespective of any DC common mode voltage in the background.

The signal level is measured once per bit, at the sample point. The sample point is a specific moment in time, defined as a percentage of the bit time. So, very simply: in order to make sure that a network is robust, it shall guarantee at this sample point, the signal levels shall be stable, whether dominant or recessive.

The first complication, before considering what effects can disturb the network signals, is to understand that sample points on two nodes, a sender and receiver, can and do move relative in time to one another. Therefore, if we require stable signals at the sample point, we need to calculate when the earliest and latest possible sample points may appear. We can then refine our previous statement to say that the signal levels shall be stable by the earliest possible sample point and remain stable until the latest possible sample point.

There are different factors affecting the shift of sample points:

- ◆ The drift of the oscillator in the sending and receiving nodes, where one may run fast and the other slow, creating a timing drift between the two.
- ◆ The asymmetry of the CAN transceiver, which is the difference in time between a dominant to recessive transition and a recessive to dominant transition. This is specified in the datasheet of the transceiver, with limits defined for 2 Mbit/s and 5 Mbit/s in the ISO 11898-2:2016 (for reference, refer to section 5.6 of that document). In fact, these limits are not intrinsically linked to the bit rate and many car makers now require the tighter specification of 5 Mbit/s to be met even in CAN FD networks operated at 2 Mbit/s.
- ◆ The asymmetries of the interface between the micro-controller and CAN transceiver. For calculations, both the TXD and RXD pins need to be considered, where 5 ns is a typical reference value.
- ◆ Lastly, the worst case time quanta delay. The signal may arrive at the receiver just after the last time quanta, meaning there is a worst case delay until the next time quanta measurement.

These factors are all additive and should be calculated based on a worst case bit pattern to give the longest time period between a synchronization point (a recessive to dominant transition) and a sample point, namely five dominant bits followed by one recessive bit.

These can be calculated for any bit rate, but for illustration, an example is shown for a bit rate of 2 Mbit/s with a sample point of 70 %, commonly used in CAN FD networks. Here the nominal sample point would be 500 ns x 70 % = 350 ns.

There is an additional calculation for a sending node reading back their own signal, which is also important to verify. For those who are curious, the details behind each of these calculations can be found in our iCC 2017 article [“Managing the Transition to Robust CAN FD”](#). ▷

Table 1: Calculated asymmetries for a remote receiving node in a 2-Mbit/s CAN FD network with a sample point of 70 % (Source: NXP)

Parameter	Earliest	Latest	Note
Oscillator drift	-16,1 ns	+16,1 ns	Bit rate dependent. Assumed tolerance of $\pm 0,3$ %.
Asymmetry of sender's transceiver	-45,0 ns	+10,0 ns	Constant. Based on ISO 11898-2:2016.
Asymmetry of receiver's transceiver	-45,0 ns	+15,0 ns	Constant. Based on ISO 11898-2:2016.
PCB tolerances	-10,0 ns	+10,0 ns	Assumed 2 x 5ns for MCU-TXD and RXD-MCU.
1 time quanta at the receiver (remote node)	24,9 ns	-	Based on clock frequency (assumed 40 MHz).
<b>Worst case sample points (remote sender):</b>	<b>209,0 ns</b>	<b>401,1 ns</b>	

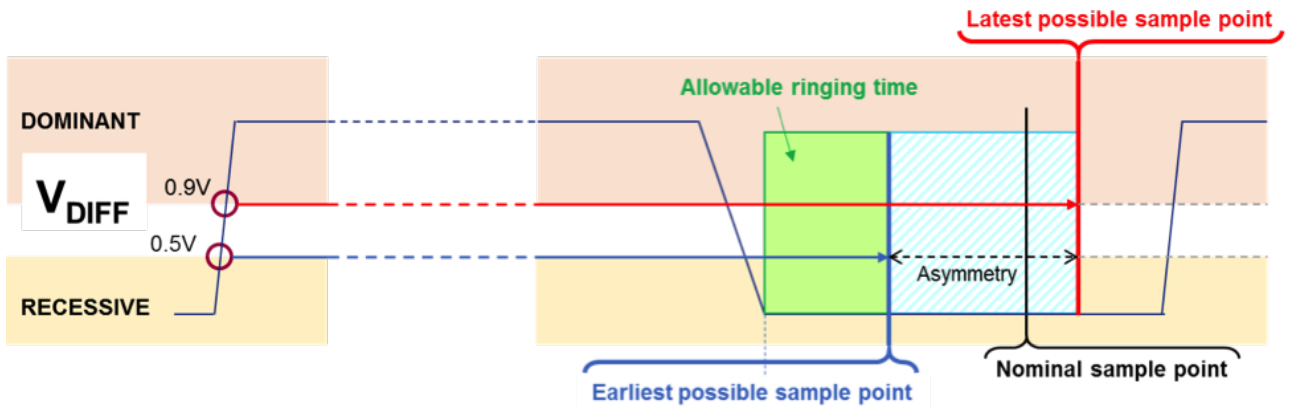

Figure 1: Calculated asymmetries visualized in the recessive bit (Source: NXP)

What can be concluded is a sample point can potentially move much earlier in the bit – at 209 ns in this example (28 % earlier in the bit time vs. the nominal sample point). Thus, for network communication to be robust, its signal needs to be stable much earlier in the bit. Conversely however, we can infer that what happens prior to this earliest sample point is not relevant, as this will never be sampled. This is what we call the allowable ringing time, as any kind of signal distortions here can occur without affecting the network operation.

A complete picture of the full worst case bit pattern with all asymmetries shown is given in Figure 2. The green area demarks the boundary where the CAN signals can safely appear without compromising the network robustness, defined as the “safe operating area”. The colors

shown in the boxes are the associated contributions from the different components listed in the table above.

### The typical worst case simulation

To judge if a network is meeting these criteria and remaining in the safe operating area, a network simulation is normally required to check all cases. In simulation, all possible signal combinations are generated between all possible transmitting pairs and then assessed against the above safe operating area. A complete overview of the communication can be checked to determine if the network is robust or not. If not, the nodes causing the violations can be easily identified.

**Tools for Test and Production**  
**LIN & CAN**  
 LINWorks  
 C/C++  
 .NET  
 LabVIEW  
 Python  
 Windows/Linux  
 SPS/PLC  
 Raspberry Pi

**Development**  
 EOL  
 Test  
 Digital I/O  
 PWM  
 Analog Inputs

**Protocols and Services**  
 Raw, DTL, ISO-TP, UDS, etc.

**USB**  
**Ethernet**  
**RS 232**  
**Digital I/O**

**CAN FD**  
 (up to 2 channels)

**CAN HS**  
 (up to 2 channels)

**CAN LS**

**LIN**  
 (up to 6 channels)

**Multi-PDU**  
 E2E  
 SecOC  
 Functionality  
 Identification  
 Configuration  
 Traceability

**LIPOWSKY INDUSTRIE-ELEKTRONIK**

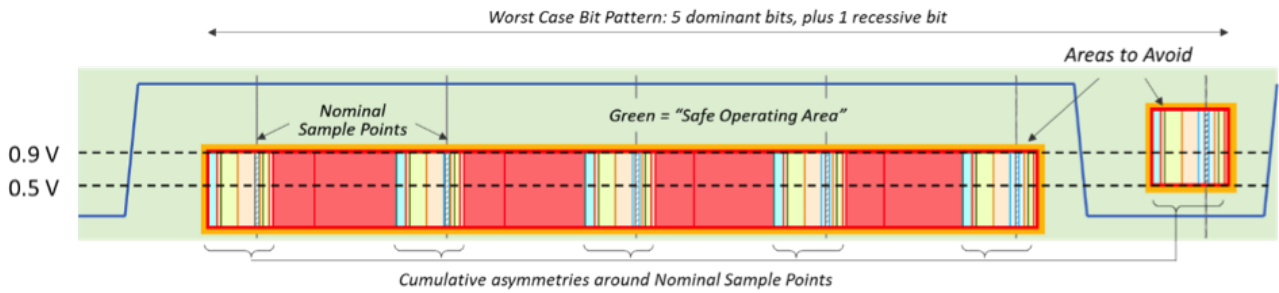

Figure 2: Full visualization of all asymmetries in a worst case CAN FD bit pattern (Source: NXP)

Usually, one would perform a worst case simulation, which uses the worst case parameters stored in the simulation model (selectable in the simulation tool). In our experience however, using this in combination with the worst case timing asymmetries calculated above is not realistic. This is because the worst case simulation model considers all worst case parameters taken from the data-sheet, taking each characteristic as an individual potential worst case value, without considering which combination of characteristics are possible at a single moment in time. Furthermore, a transceiver’s output driver stability over temperature is much more stable than the datasheet limits are typically predicting.

Instead, our experience leads us to recommend using the typical parameter set in a simulation model, which already gives a very good matching with real world results. The advantage of this approach is not to purely increase the achievable operating space of the network, although this is a desirable benefit. It has the added advantage that simulation results can be easily cross-checked with bench testing, since the simulation conditions used are the same. The margin that would normally be part of the worst case simulation model is now moved into the margin of the safe operating area, since the definition of this contains all worst case asymmetries. Furthermore, the opposite approach can also be taken for those without easy access to network simulation: assessing bench measurements against the same safe operating area can provide a first indication if the network will operate reliably or not. This can simplify early pre-assessments on a network, giving early insights

if a topology will operate robustly, and giving confidence when cross-checking simulation results once available.

### Factors affecting robust communication

Having now a sound basis for network assessment, we can now look at some common factors that are important in good network design. One of the biggest topics that prevents signals to be stable in CAN FD is signal ringing. Signal ringing is created by impedance changes in the cable harness, for example at cable branches with unterminated stubs. This is not a new artifact and is already present in many Classical CAN networks today, but the bit times are usually sufficient to allow signal ringing to dissipate and avoid any issues in communication.

As CAN FD has much faster bit rates, and consequently shorter bit times, the available time for the signal ringing to dissipate is much shorter, so hence this is one of the most critical parameters to manage from a network design perspective.

The current state of the art is to use a highly linear topology with only a limited number of nodes and short stub lengths, either as a daisy chain topology or in a network of very limited size. This is effective in managing the ringing, but comes with several disadvantages, such as limitations on how cables can be routed between nodes, and likely an associated cable length penalty. In such routing schemes, managing the diversity of networks becomes problematic, if one or more nodes are optional. This may require creating more harness options or deriving more complex (read ▶

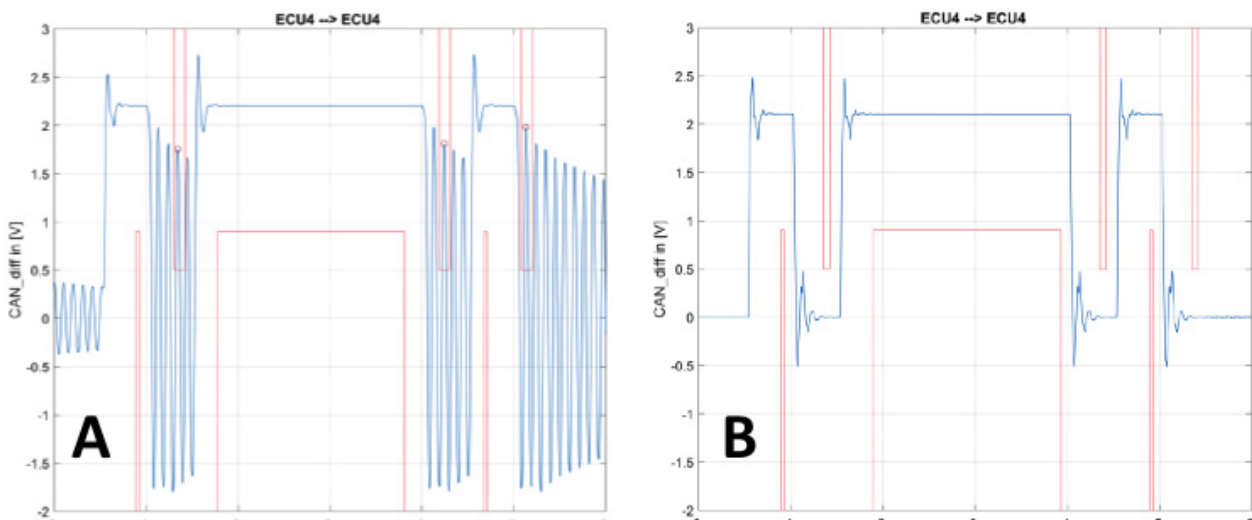

Figure 3: Comparison of signal ringing with (A) conventional HS-CAN transceivers and (B) NXP's CAN SIC transceiver (Source: NXP)

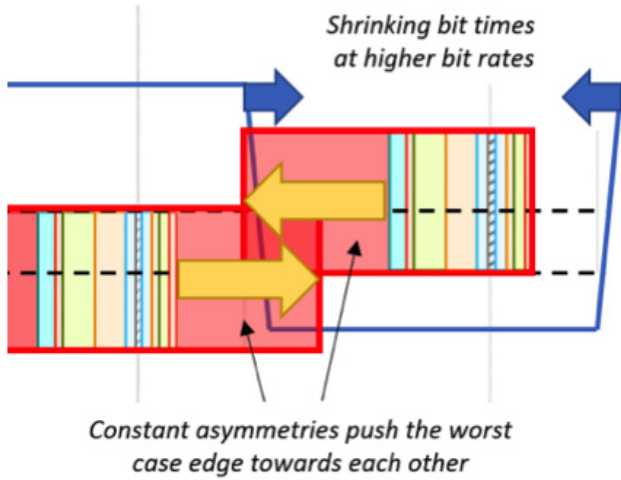

Figure 4: As bit times reduce at faster bit rates, asymmetries become relatively larger part of the bit (Source: NXP)

“expensive”) solutions for the harness construction. Additionally, more network branches might be needed to manage the smaller number of nodes per branch.

Many of these problems can be overcome however with the recent innovation of the CAN SIC transceiver, now specified in the CiA 601-4 version 2.0.0 specification.

These transceivers have a dramatic improvement on the signal ringing present in a network and enable network architects to return to complex CAN FD network topologies at higher bitrates. These transceivers offer two primary benefits in their way of working: the signal improvement technique itself and a much tighter asymmetry performance, which will now be reviewed.

### Benefits of CAN signal improvement

Figure 3 (A and B) shows two comparative simulation results of a star network of four nodes, a central 60-Ω split star termination and four unterminated stubs of 2 x 5 m and 2 x 0,75 m. Picture A shows the signal with regular high-speed CAN (HS-CAN) transceivers operating at 2 Mbit/s, demonstrating the resultant signal ringing oscillating through the recessive bit. The boundaries of the safe operating area are shown as the red lines, where there are clear violations – confirming, this is not a reliable topology. In contrast, Picture B shows the signal with NXP’s CAN SIC transceiver. The signal ringing is brought quickly under control and even this heavily ringing network is able to operate reliably at 2 Mbit/s.

As a general rule of thumb, our experience shows that network topologies already working at 500 kbit/s with regular HS-CAN transceivers will operate with CAN SIC transceivers at 2 Mbit/s and potentially faster, depending on the topology. The rationale behind this is that while it is always possible to engineer a network that will not operate, if standard rules of CAN network creation are generally followed, very large topologies are possible at 2 Mbit/s.

Secondly, we also see that networks validated at 2 Mbit/s with HS-CAN transceivers will generally operate at 5 Mbit/s with CAN SIC transceivers, and potentially faster, depending on the topology. The reason for this is typically 2 Mbit/s networks have reduced levels of signal ringing with HS-CAN transceivers. When CAN SIC transceivers are



# YOUR LINK TO THE WORLD OF MODERN AUTOMATION - X90

[www.br-automation.com/mobile-automation/](http://www.br-automation.com/mobile-automation/)

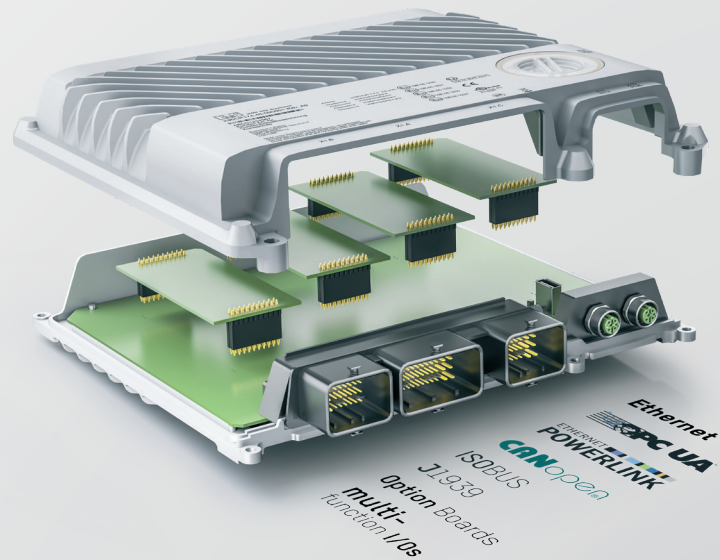

- Scalable hardware platform
- Preprogrammed software components
- 3-times faster development

PERFECTION IN AUTOMATION  
A MEMBER OF THE ABB GROUP



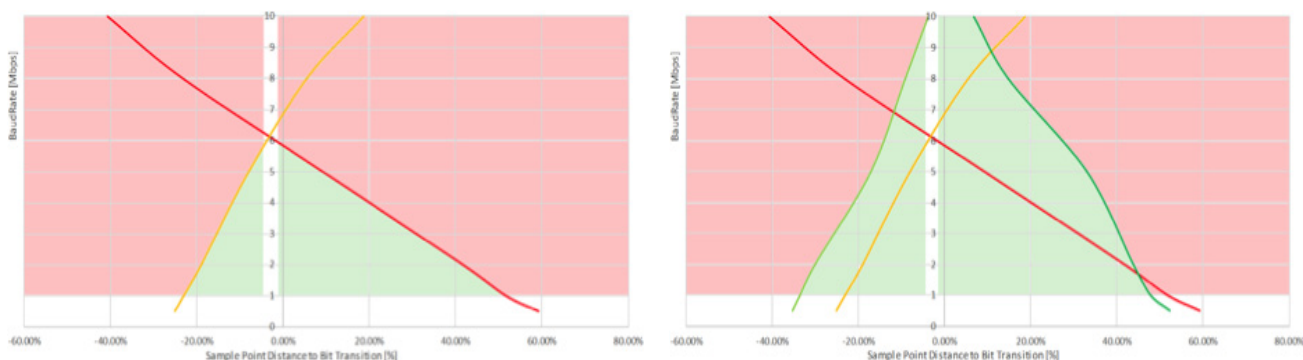

Figure 5: Comparison of the maximum bit rates achievable with HS-CAN transceivers (left) and CAN SIC transceivers (right) (Source: NXP)

applied, there typically needs to be no signal peaks greater than 0,5-V differential voltage at all. This is required since the available margin to the earliest sample point is very limited, so any remaining peaks will typically violate the limits of the safe operating area. Nonetheless, this does not mean that only highly limited topologies can be made with 5 Mbit/s. In the simulation example shown earlier in the article, Picture B shows no peak above the 0,5-V level implying this extreme topology can also reliably operate at 5 Mbit/s with CAN SIC transceivers. This demonstrates that CAN FD operating at 5 Mbit/s is now a realistic proposition for network architects to consider in their network design, where previously this was limited to essentially point-to-point connections.

### Tighter asymmetry

The second benefit of the CAN SIC transceiver is its tighter asymmetry performance, briefly covered in our [previous article](#). Using the asymmetry calculations made in the opening section, it can be seen that many of the components of the total calculation are constants and not bit rate dependent. That means that as bit rates increase, the earliest sample point will move further forward in the bit and the latest sample point will move later in the bit (Figure 4). As the bit rates increase, at some point there becomes a collision between the earliest sample point of the recessive bit with the latest sample point of the previous dominant bit, shown in Figure 5. This will define the speed limit for the CAN FD communication, as beyond this point, there is no reliable path from a dominant to recessive bit. Consequently, there is a possibility that a complete bit may be lost, resulting in communication errors.

We can plot this on a graph, showing the position of these extreme sample points on the horizontal axis versus increasing bit rates on the vertical axis to see at what speed they collide.

The left graph (Figure 5) shows these critical edges for ISO 11898-2:2016 compliant transceivers, based on the 5 Mbit/s bit timing specifications. Here it can be seen that the latest possible sample point in the dominant bit (shown as the yellow line) and the earliest possible sample point in the recessive bit (the red line) collide just above 6 Mbit/s. This becomes the theoretical limit of robust CAN FD communication.

CAN SIC transceivers offer a significant improvement on the ISO 11898-2:2016 specification in terms of the required transceiver symmetry. Table 2 shows a comparison table between these two values. The effect is that the earliest possible sample point is now much later, reducing the overall asymmetry. The right hand graph in Figure 5 shows the effect on the earliest and latest possible sample points for CAN SIC transceivers, overlaid with the calculation of the HS-CAN transceivers for comparison. This shows a path from the dominant to recessive bits remains available far beyond 5 Mbit/s and even extending beyond 10 Mbit/s.

As an aside, some HS-CAN transceivers on the market are already claiming 8 Mbit/s operation in their datasheets. User judgment is recommended in assessing whether the stated values quoted in these datasheets are sufficient to reliably meet the maximum bit rate in all conditions or not.

### Sample point selection

One choice also worth mentioning in this study is the sample point selection, particularly for faster bit rates, ▶

Table 2: Comparison of asymmetries for ISO 11898-2:2016 compliant transceivers and CAN SIC transceivers (Source: NXP)

Parameter	ISO 11898-2:2016 compliant transceivers		CAN SIC transceivers, defined in CiA 601-4 version 2.0.0	
	Earliest	Latest	Earliest	Latest
Oscillator drift	-16,1 ns	+16,1 ns	-16,1 ns	+16,1 ns
Asymmetry of sender's transceiver	-45,0 ns	+10,0 ns	-10,0 ns	+10,0 ns
Asymmetry of receiver's transceiver	-45,0 ns	+15,0 ns	-20,0 ns	+15,0 ns
PCB tolerances	-10,0 ns	+10,0 ns	-10,0 ns	+10,0 ns
1 time quanta at the receiver (remote node)	24,9 ns	-	24,9 ns	-
<b>Worst case sample points (remote sender):</b>	<b>209,0 ns</b>	<b>401,1 ns</b>	<b>269,0 ns</b>	<b>401,1 ns</b>



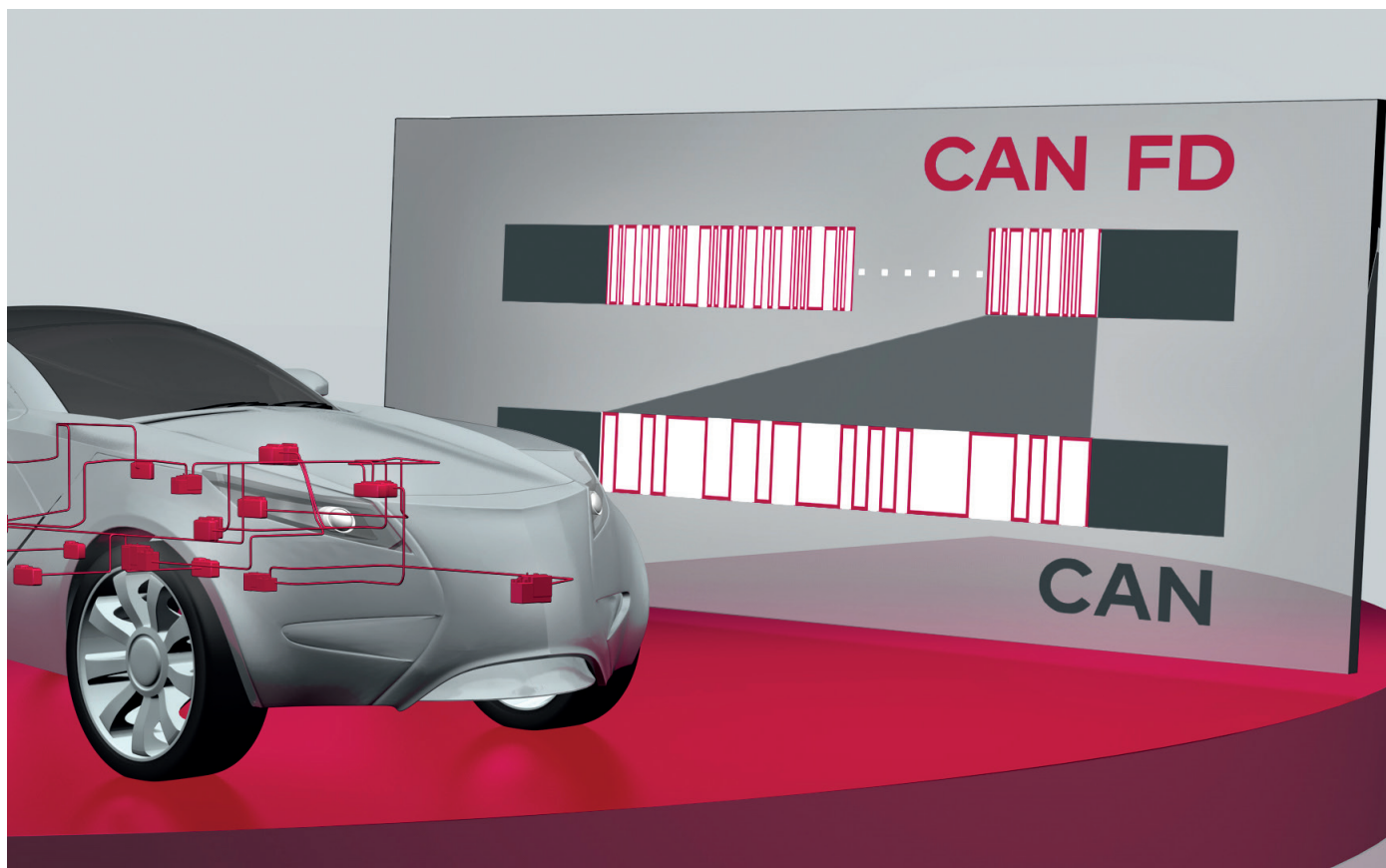

## First Class Solutions for Your CAN (FD) Projects

### Your Universal Tool Chain

**Increase efficiency of your projects with the universal tool chain from Vector:**

- > High-professional tools for testing, flashing and calibrating ECUs
  - > Flexible network interfaces
  - > New all-in-one network disturbance interface
  - > Powerful logging solutions for test fleet operators
  - > High performance oscilloscope
  - > Proven design tools for network architectures
  - > Easy to configure AUTOSAR basic software
  - > Worldwide engineering services and trainings
- More information: [www.can-solutions.com](http://www.can-solutions.com)

**More CAN power by Vector: benefit from 30 years of networking experience.**

which is slightly different compared with the normal sample point selection at slower speeds, e.g. 2 Mbit/s.

At 2 Mbit/s, the sample point should be later in the bit to allow maximum time for ringing. This is normally chosen around 70 % with standard HS-CAN transceivers, but could be delayed even to 80 %. The approach of delaying the sample point to boost the available topology space as much as possible is still recommended and a move to an 80 % sample point would provide the maximum time for ringing, even with CAN SIC transceivers.

At 5 Mbit/s however, as noted above, any ringing remaining above the 0,5 V is likely to already touch the boundary of the safe operating area, so shall be avoided completely. Accordingly, it is no longer necessary to delay the sample point to later in the bit and in fact, moving closer to the middle of the bit is preferred to provide additional margin for jitter effects or PCB (printed circuit board) impacts. As a guideline, we would recommend a sample point of 50 % + 1 tq, which is approximately 55 %.

Please note, this also applies to the secondary sample point as well, which should be set the same as the nominal sample point. Incorrect setting of the secondary sample point is the cause for many support cases of CAN FD networks, providing a latent problem, likely not visible on ECU (electronic control unit) tests. This issue may never arise if operating at lower bit rates, e.g. 2 Mbit/s, but for higher bit rates, such as 5 Mbit/s, this will definitely be encountered. It is therefore vitally important to check the secondary sample point is correctly set to the same as the normal sample point when operating at higher speeds.

## Cabling choices

The CiA 601-6 specification provides guidance on creating CAN FD networks and includes the statement in section 8.1.1 that cable impedances should be within 110 Ohms to 140 Ohms. Furthermore, it even gives a cautionary word, "Note – PVC-based wire-insulation material does not meet this requirement".

This warning is given due to two effects of the cables, namely a greater sensitivity to temperature that can significantly reduce the impedance of the cable, and a higher propagation delay. The impedance change creates a larger impedance mismatch and so accentuates ringing effects in the network, creating a higher reflection peak; the longer propagation time means that peak would arrive later. Please note, the network simulations shown here are made according this guidance.

The effect of CAN SIC transceivers provides some compensation for poorer performing cables however, due to the tighter symmetry, faster recessive edge, plus the signal improvement actively drives the signal towards recessive. Caution is needed however, and the worst case network simulation defined above would not be sufficient to make this assessment, due to the high temperature dependency of the cable. Also, due to the high variance even across different kinds of PVC (polyvinyl chloride) cables, it is highly recommended to cross-check the performance of the specific cable to be used over temperature. However, CAN signal improvement technology can certainly improve the reach of what is possible and in relatively simple networks, PVC cables may be considered.

## Conclusions

In this article, the way of confirming if a network topology is robust has been reviewed, showing how assessments based on worst case asymmetry timings can be even used in bench measurements to simplify network assessments. The recent innovation of CAN SIC transceivers shows how CAN FD can move beyond limited networks to large, complex topologies and at faster bit rates, through only using a simple drop-in replacement transceiver. ◀



### Author

Tony Adamson  
NXP Semiconductors  
[info@nxp.com](mailto:info@nxp.com)  
[www.nxp.com](http://www.nxp.com)



## Welcome to the new Kvaser Memorator Light v2

Simple to use. No configuration or software setup required.  
Ideal for monitoring intermittent faults. More than enough  
memory to capture an entire test drive.

---

### Features include:

- ▶ Autobaud function automatically determines CAN bus bit rate.
- ▶ Silent mode: Log traffic without interfering on the bus.
- ▶ Rugged & Reliable: the memory card is attached to the PCB.
- ▶ Two FIFO buffers: Log all messages & the messages before and after an error frame.
- ▶ A built-in real time clock with battery backup.

---

To find out more, visit [www.kvaser.com/kvaser-memorator-light-hs-v2](http://www.kvaser.com/kvaser-memorator-light-hs-v2)

# Facts & Figures

## 1,47 billion

For Markets has published a market research report about automotive data-loggers. This market is expected to grow from US-\$ 4,48 billion in 2017 to US-\$ 8,69 billion in 2025. Data-loggers with Classical CAN and CAN FD connectivity held the largest market share and valued at US-\$ 1,47 billion in 2017.

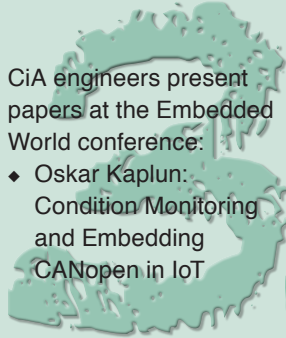

CiA engineers present papers at the Embedded World conference:

- ◆ Oskar Kaplun: Condition Monitoring and Embedding CANopen in IoT
- ◆ Yao Yao: CANopen FD Devices Identification via New Layer Setting Services (LSS)
- ◆ Reiner Zitzmann: Migration from Classical CAN to CAN FD

Part 2 and part 3 of this ISO standard series specify the J1939-based communication between towing and towed heavy-duty vehicles. Currently, the two standards are under systematic review. Part 3 has been submitted for balloting. It introduces 21 parameter groups containing object detection information. For part 2, Wabco, recently acquired by ZF, has proposed several new suspect parameters for trailer e-drives. In Europe, ISO 11999-2 is mandated by the legislation for truck and trailer communication.

## ISO 11992

## COB-ID

The COB-ID is a CANopen communication parameter. It is a 32-bit value containing the 11-bit or 29-bit CAN-ID plus three control/status bits. One of these control/status bits is used to indicate the length of the CAN-ID. Another bit is used to enable or disable the corresponding CANopen service, the TPDO 1, for example.

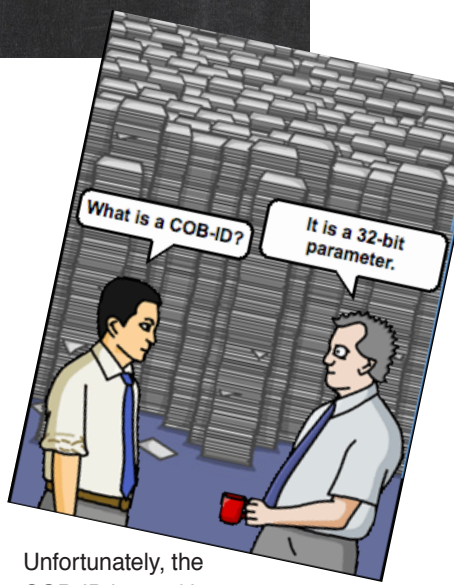

Unfortunately, the COB-ID is used in many documents as synonym for CAN-ID.



The international CAN Conference takes place in Baden-Baden (Germany) on March 17 and 18, 2020. One of the topics is the introduction of CAN XL, the third CAN data link layer generation.



Recently, version 2.1.1 of the technical specification for remote FMS (rFMS) has been published. The document developed under the umbrella of the ACEA association is ready for [download](#).



This remote fleet management system communication specification is based on the SAE J1939 application layer and profile. There is a separate registration (no fee) required, to get access to the download areas.

The CiA international users' and manufacturers' group has 673 members (date: 2020-02-15). Most of the members are located in Germany. The nonprofit association has been established in March 1992. The next general assembly electing annually the board of directors takes place on March 16, 2020.

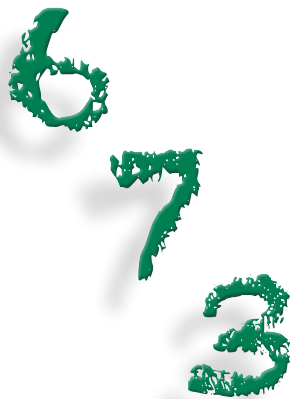

At the trade show in Nuremberg (Germany) some 1 150 exhibitors present their products to about 30 000 visitors, forecasts the organizer.

**Embedded World 2020**

Traditionally, many CiA (CAN in Automation) members are among the exhibitors as well as the CiA non-profit association.

## HIGH-END CONNECTIVITY AND DATA MANAGEMENT

## TELEMATICS AND CLOUD SYSTEMS FOR IOT AND SERVICE 4.0

[www.s-i-e.de](http://www.s-i-e.de)

Visit us at  
Embedded World:  
Hall 1, Booth 581



Sontheim

### Continuous digitization for smart vehicles

Modular on-board units with Linux – ready for condition based monitoring. Including flash-over-the-air and embedded diagnostic functionality.

Sontheim IoT Device Manager and IoT Analytics Manager – for a highly secure, comfortable and individual visualization and management of your data.

### Telematic ECU – COMhawk® xt



IoT Device Manager  
and IoT Analytics  
Manager



Integrated  
flash-over-the-air  
functionality



Modular on-board  
telematics series



Embedded  
diagnostics  
functionality



Multi-protocol  
support (J1939,  
J2534, UDS, KWP, ...)



Ready for  
condition based  
monitoring

# Challenges for wiring harness development

We are living in an era of major disruption in the automotive industry. Driven by the rapid development of new technologies and the proliferation of automotive start-ups, both trends have implications on the development of vehicle wiring harnesses.

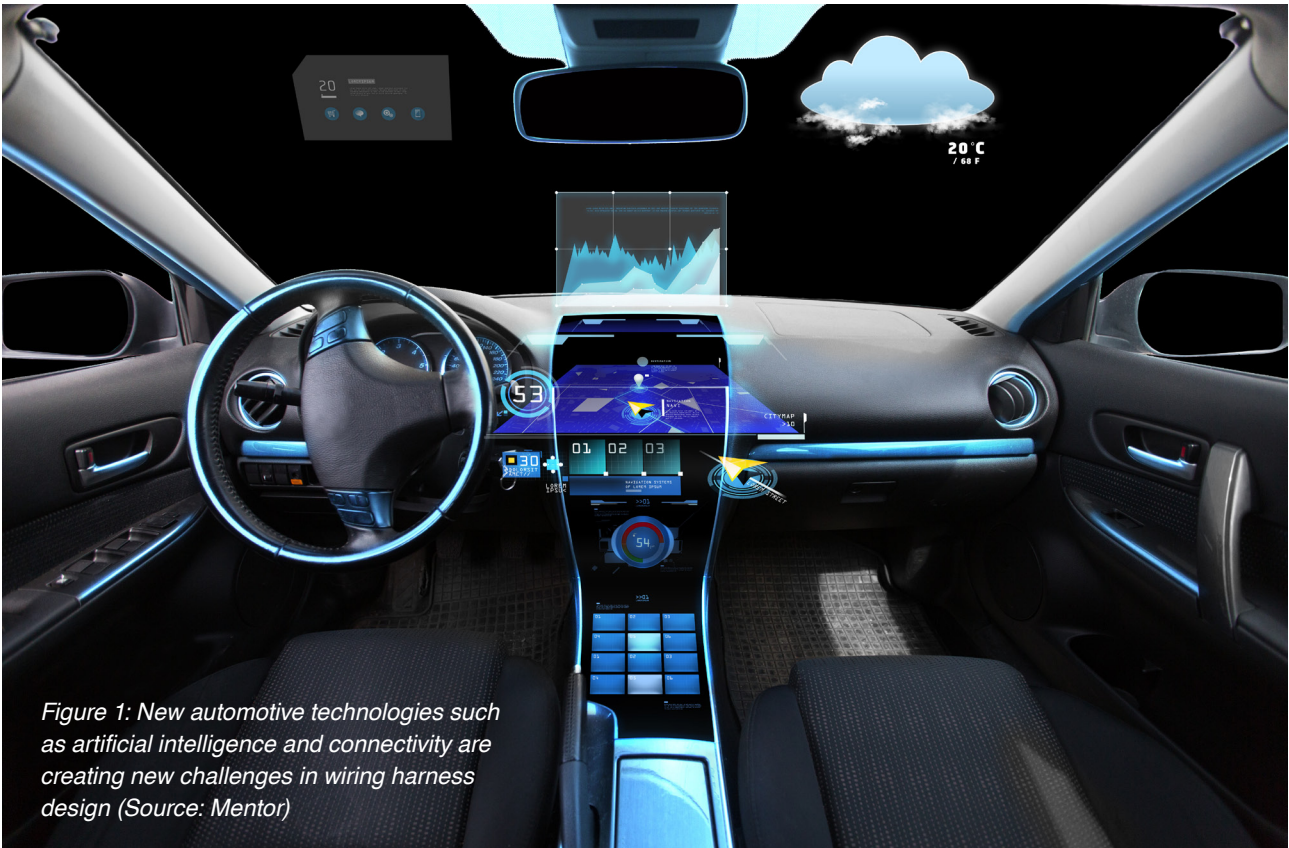

Figure 1: New automotive technologies such as artificial intelligence and connectivity are creating new challenges in wiring harness design (Source: Mentor)

The never-ending development of new technologies and their addition to modern vehicles leads to a phenomenon that can be labeled as the content dilemma. The content dilemma represents the conflict between the technology content that vehicle manufacturers try to integrate into their vehicles, and the weight, cost, and packaging space required for wiring harnesses.

Examples of recent technology trends that are driving the content dilemma include (Figure 1):

- ◆ Electrification
- ◆ Autonomous driving
- ◆ Artificial intelligence
- ◆ Connected vehicle

A key competitive factor for customers in an electric vehicle is range. The more miles a vehicle can drive with one charge, the better. Vehicle mass plays a key role in determining a vehicle's range, therefore, minimizing weight in an electric vehicle is crucial to bringing a competitive and successful vehicle to market. New vehicle technologies, however, require additional electrical wiring and other electronic components, increasing the weight of the

vehicle. The introduction of the electric powertrain alone adds about 30 % more weight compared to an internal combustion engine powertrain.

Autonomous driving requires the addition of a multitude of hardware redundancies and fail safe mechanisms to prevent single points of failure that could disable the autonomous system unexpectedly. System redundancies are critical because unexpected failures may cause the vehicle to crash if the driver isn't paying attention or actively involved in the driving and steering process. However, these safety redundancies can add significant weight and cost to the wiring harness by duplicating networks, powerlines, and some electronic control units (ECUs).

Artificial intelligence in vehicles enables facial recognition, computer vision, and other machine learning algorithms to help personalize the user experience and vehicle settings by processing and 'learning' from incoming data. This requires the inclusion of a myriad of cameras and other hardware all over the vehicle. These cameras are usually connected to an electric control unit via high bit rate networks. Most automotive networks use unshielded twisted

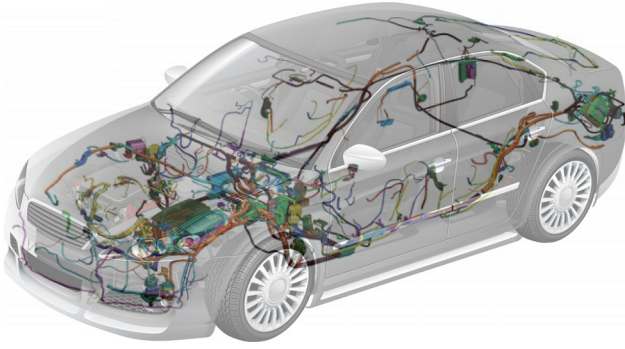

Figure 2: Growing electrical and electronic content in vehicles is increasing bandwidth demands in the vehicle. OEMs are responding by incorporating additional networks, both standard and specialized, leading to harnesses that are heavier, costlier, and more complex. (Source: Mentor)

pairs of wires, such as CAN. In a CAN network, cables can sometimes even be twisted during harness assembly to avoid the use of costly specialty cables in the wiring harness. Higher bit rate networks, on the other hand, are more likely to need special grades of cable, shielding, and sometimes more complex pre-assembled cable types like Coax. These specialty cables are significantly larger, heavier, and more expensive than conventional automotive wiring. Therefore, it is typically preferred to minimize the usage of these where practical.

Last, but not least, vehicles are becoming highly connected as part of the Internet of Things and Internet of

Vehicles, transforming the vehicle into a seamless interface between our connected lives at home and at work. The integration of screens and displays into almost any imaginable interior surface demonstrates the vehicle's growing role as a hub for entertainment, communications, and productivity.

All this technology has to be connected together, driving OEMs (original equipment manufacturers) to incorporate more networks, such as CAN, and leading to wiring harnesses that are heavier, larger, costlier, and more complex (Figure 2). Some modern vehicles contain close to 40 different harnesses, comprised of roughly 700 connectors and over 3 000 wires. If taken apart and put into a continuous line, these wires would exceed a length of 2,5 miles (4 km) and weigh approximately 132 lbs (60 kg). In addition, OEMs will need to integrate high bit rate networks with specialty cabling to support the increased features and functionality of new vehicles. Modern vehicles can contain more than 70 specialty cables, such as coax, high speed data, and USB cables. In older cars, this number was closer to ten.

How can today's automotive manufacturers solve the content dilemma? Via the introduction of methods that help development teams to reduce the impact of added content and technology on the weight, cost, complexity, and packaging space required for wiring harnesses.

One solution is to develop technologies that reduce harness weight. Ultra-small diameter wiring (0,13 mm<sup>2</sup>) is one good example. Unfortunately, the industry is still ▶

# CAN and CAN-FD Products for your requirements



**CAN-FD Gateway**



**Ethernet/CAN Gateway**

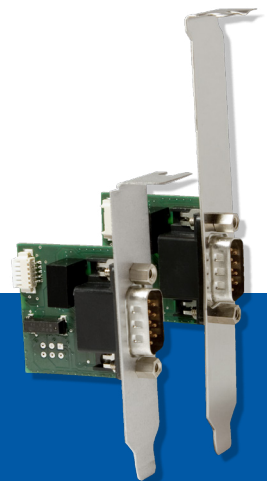

**Embedded USB/CAN Interface**

- Economical solutions for series applications
- Optimized for industrial applications
- Solutions for stationary and mobile use
- Software support for bus-analysis, measurement and control



Sonnenhang 3  
D-85304 Ilmmünster  
Tel.: +49-8441-49 02 60  
Fax: +49-8441-8 18 60  
[www.ems-wuensche.com](http://www.ems-wuensche.com)

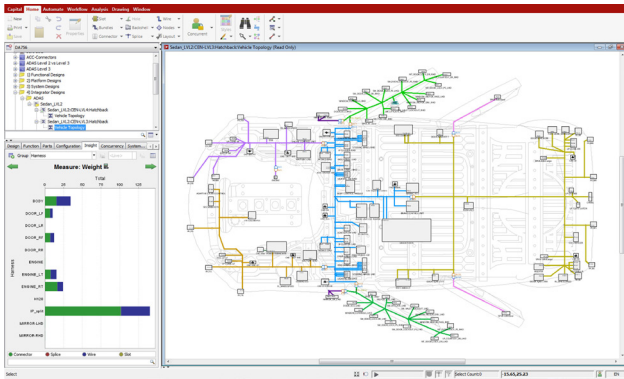

Figure 3: Capital enables tradeoff studies with cost, weight, and bundle size metrics to optimize a harness design. (Source: Mentor)

struggling to develop a sufficient number of terminal substitutions for all currently existing terminals that can crimp to such a small wiring diameter. Reducing the wire size on common circuit types, such as CAN networks, can achieve quick weight savings without necessitating a complex subset of connectors and pins, but the available products on the market currently do not support a large-scale migration to ultra-small diameter wiring.

The same applies to aluminum wiring. For small diameter wiring, pure aluminum is too brittle and thus not a feasible option. Terminal suppliers have begun developing optimal aluminum alloys for the specifications of their terminals. This has led to a multitude of different alloys on the market that, in most cases, are incompatible with other suppliers' terminals. This, in turn, means that a vehicle would have to be solely comprised of one supplier's connectors to be able to use aluminum across the full vehicle, which is not realistic.

Additionally, switching to aluminum wiring would require the compression of the aluminum core to reduce bundle sizes in addition to weight. Due to its material characteristics aluminum wire diameters have to be upsized by at least one size to keep the same conductivity as copper wiring. Switching to larger diameter aluminum wires across an entire vehicle, or even a portion of the vehicle, would result in a significant increase of bundle sizes and require more packaging space.

Finding alternatives to specialty cables will further reduce the weight, cost, and bundle diameters of harnesses. The number of cameras and displays will only increase in the future. OEMs must balance between using high bit rate networks that require specialty cabling or installing a greater quantity of lower bit rate networks, based on the resulting cost, weight, complexity, and risk of the harness. In the near term, widely used standards, such as CAN FD, that provide higher bit rates while operating on inexpensive twisted pair wiring may provide an easier and lower risk upgrade path. Alternatively, finding ways to multiplex these signals onto one shared specialty cable and having multiple devices tap into these cables, will have the same effect: reducing harness weight, cost, and bundle diameter.

Another approach is using advanced software solutions, such as Capital from Mentor Graphics, that support tradeoff studies to optimize module locations and identify any modules that can be combined to save weight, cost,

and reduce bundle sizes (Figure 3). With the ability to compare and analyze layouts for their impact on harness weight, cost, and bundle diameter will enable engineers to choose the most optimal system architecture.

## The advent of automotive start-ups

Over the last 10 years to 15 years, the automotive industry has been revolutionized by a second trend: the proliferation of automotive start-ups. Today, it is not just the established legacy OEMs like Ford, VW, or Toyota anymore. Since the founding of Tesla in 2003, more and more electric vehicle (EV) start-ups keep entering the market. This brings its own group of challenges with it.

EV start-ups face unique challenges such as:

- ◆ Reduced time-to-market
- ◆ Lack of infrastructure
- ◆ Bottom up design
- ◆ Constant change

Reduced time-to-market leads to something called the timing dilemma. New vehicle development cycles at an established OEM take about four years or five years. In comparison, most start-up EV companies commonly aim to launch a vehicle in a much shorter period of time, sometimes less than half of the time of an established OEM budgets. Further amplifying this dilemma is that start-up EV manufacturers are starting their development from scratch, without the legacy of previous vehicle programs. This short time to market leads to very short iterations or development phases.

Shortened iterative cycles and development phases are not problems in themselves, but become problems when paired with the long lead times needed for harness development. The usual lead-time for harnesses, from design release to product delivery, is approximately 23 weeks to 26 weeks. Variance in lead-time depends on the number of changes and the amount of progress that a project has made in the development cycle. To meet deadlines for the next development phase, harnesses have to be frozen (where the data/design is released and has to go through formal change management processes to be updated) leaving little-to-no time to examine or implement lessons learned in between development phases. Frequently, vehicle testing has not even started when the next freeze comes due. This can lead to massive rework efforts once the next build phase starts, or "machine gun" change requests to implement changes into the harness design as quickly as possible before the next freeze. Both alternatives can deteriorate the quality of the harnesses and can cause unnecessary delays during functional validation.

Reducing lead times during the engineering and manufacturing phases will benefit all the engineering teams. More lead-time provides teams with more time to find issues, determine appropriate wiring changes, and implement those changes in the design for the next validation phase. How can this lead-time reduction be achieved? By eliminating manual steps and automatically cascading information from one step to another. This significantly reduces mistakes and the need to double check work results. The goal is to create a seamless integration between the vehicle manufacturer's and supplier's tool chains. ▶



## Lack of infrastructure

Start-ups endeavoring to develop new vehicles must also contend with a lack of business and engineering infrastructure. During the early stages of a start-up there are no processes in place. Specifically related to wiring development, there is no device transmittal database to help with the gathering, organization, and verification of the electrical data needed for the harness design. Start-up manufacturers also do not have a component library of certified connectors, terminals, seals, or company standards for network implementations. At an OEM, this kind of infrastructure has been built up and tested over a long period. At a start-up, all of this has to be created from scratch, requiring a lot of time and effort when resources are limited, and deadlines are looming.

With more and more start-ups entering the market, harness development tools with an integrated device transmittal database and component library will provide a profound advantage to wiring teams. They eliminate the need for tedious data gathering via Excel sheets and the manual data transfer into logical schematics, a process prone to human error. They can also assist with the implementation of CAN and other network standards. As engineers work they can capture knowledge gained in design rules, helping to build company IP. Harness development tools will streamline and automate the process to reduce mistakes and improve the overall harness quality from early design stages.

Such a database can also run automated reports for open-ended circuits, missing load information, and more. Having a component library in place will considerably reduce the need for part research to find terminals, seals or mating connector part numbers. Incorrectly pinned connectors, caused by operator error or incorrect information on the endview definition, are among the most common errors. A component library that provides endviews for each part number will eliminate the guesswork when assigning pin numbers to cavities and prevent these mistakes.

## Design differences

Usually, established OEMs employ a top-down approach to system design. In a top-down approach, the system is broken down into subsystems that are further broken down into components. Each component is then custom-designed to support a particular vehicle feature and follow specific requirements, for example, using a connector from a limited set of connector families from approved suppliers.

The timing and budgetary restrictions present in a start-up do not usually allow a top-down approach. Instead, the engineering teams use a bottom-up design of the vehicle. The engineering teams are directed to use off-the-shelf parts that are closest to fitting the intended application. The systems engineering and wiring teams then are tasked with trying to fit all these puzzle pieces together to make up the vehicle functionality and create connectivity. Unfortunately, off-the-shelf parts cannot be altered or customized without significant investment. This regularly leads to compromises that result in the addition of wiring to the harness to integrate the part.



CAN@net NT  
CAN-to-Ethernet Gateway/Bridge  
with 4 x CAN and 2 x CAN FD

CAN and CAN FD

## Repeater, Bridges and Gateways

- Save costs due to simple wiring
- Increase your system reliability and protect devices by galvanic isolation (up to 4 kV)
- Filter/conversion functionality as well as coupling of CAN and CAN FD
- Bridging of large distances and easy system access via Bluetooth or Ethernet
- **NEW:** Cloud connection via MQTT and easy execution of tasks using "Action Rules" – no programming!



Discover more:  
[www.all4CAN.com](http://www.all4CAN.com)



CANblue II  
Bluetooth PC interface,  
Bridge, Gateway



CANbridge NT  
up to 4 x CAN /  
2 x CAN-FD



CAN-CR120/HV  
CAN / CAN FD Repeater  
(3 kV galv. iso.)



CAN-CR300  
CAN / CAN FD Repeater  
(4 channels)



CAN-CR 110/FO  
CAN / CAN FD  
to fiber optic

HMS Industrial Networks GmbH

Emmy-Noether-Str. 17 · 76131 Karlsruhe

+49 721 989777-000 · [info@hms-networks.de](mailto:info@hms-networks.de)

[www.anybus.com](http://www.anybus.com) · [www.ixxat.com](http://www.ixxat.com) · [www.ewon.biz](http://www.ewon.biz)



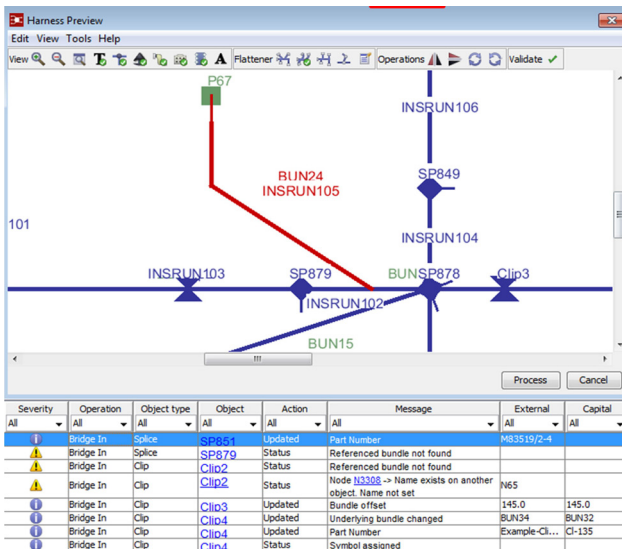

Figure 4: Modern harness design solutions have automated change management solutions (Source: Mentor)

One solution to this is to use a custom gateway or domain controller ECUs to manage the incompatibility between off-the-shelf ECUs using custom software or network configurations. Additionally, instead of having a few selected and approved connector families, the wiring team is often forced to incorporate a wide variety of connector types that can lack UsCAR certification, be difficult to procure, or be suboptimal for quality and manufacturing. The ideal harness development tool needs to be able to support bottom-up design flows and a multitude of connector types.

## Change management

After the initial creation phase, most duties of the wiring engineer are related to implementing changes. The Greek philosopher Heraclitus' said "everything changes and nothing stands still". This is the daily routine for a wiring engineer. Change is a constant in wiring harness design and engineering. In start-ups, this is even more prevalent due to stricter time constraints, ad hoc processes, and "greener" engineers.

New experts join different departments almost on a weekly basis, bringing new insights to the team. These could be a better approach to solving a problem, or new technologies they were exposed to or developed in their previous roles. These new team members are excited to leave their mark and the start-ups are hungry for such input. As a result, these ideas likely will be implemented within a short period of time and with little regard to the overall system impact. This is paired with an environment where there are few processes in place, and where change discipline is still in its infancy. In such an environment, changes are not unified, making it difficult to track the most up-to-date design revision.

By comparison, legacy OEMs have established highly efficient and rigorous change management processes. These processes have been optimized over many years and projects, and have very high organizational buy-in. Not so at a start-up. This results in constant change requests regardless of the freeze dates or current project stage.

Furthermore, not all suppliers are sourced from the beginning of the project, contributing to the recurring need for design changes. It can take a long time to source certain parts. To compensate, engineers resort to estimating data to meet the first few harness freeze dates. Once the supplier is sourced, the actual requirements usually do not match the engineer's assumptions, requiring change orders to have a functional part. In some cases, suppliers cannot meet program timing, or decide to terminate their participation. This means the parts have to be resourced. New parts rarely meet the exact electrical specifications of the original part. This leads to even more change requests modifying the harnesses.

It is extremely important to develop a structured and disciplined approach to change management early on in the project. Again, an advanced portfolio of harness development tools can provide an elegant solution. The integrated device transmittal database discussed earlier can be enhanced with certain change control mechanisms. With these enhancements, this database will provide the necessary structure and automatic change management immediately (Figure 4).

The release engineer of a device can draft the device transmittal directly in the database and submit it for approval. Upon approval, the change will be updated automatically in the logical schematics. This eliminates the error-prone process of manually updating schematics from Excel files. It also prevents release engineers from making changes to outdated local copies found on their hard drives, and overwriting changes made to the device transmittal since the last update. Lastly, for each released set of logical schematics there will be an automatically generated list of change requests implemented in each release, thus linking each change back to a specific harness revision for future reference.

The rapid introduction of new technologies and the influx of automotive start-ups into the market lead to a multitude of challenges for harness development. OEMs and start-ups alike must consider the number and sophistication of technology features they integrate into their vehicles as they have a direct effect on networks, harness weight, bundle diameter, and cost. Electrification, autonomous drive and driver assistance, artificial intelligence, and connectivity features all place additional burden on the wiring harness. These features require the introduction of dozens of new sensors into a vehicle that all must connect to the wiring harness. These additional connections can be supported by adding new networks that are either twisted pair such as Classical CAN/CAN FD, or higher bit rate requiring specialty cabling.

Start-up automotive companies face additional pressures as they race to get products to market. Start-ups lack the foundation of legacy designs and the resources needed to custom design parts for optimal performance. Without these resources, engineers at these companies must turn to a bottom-up design approach in which off-the-shelf parts are adapted to meet functional requirements. Start-ups also lack established procedures for managing and tracking change. While established OEMs possess more tenured change management processes, they tend to rely on manual data entry and communication between teams. This leads to inefficient data exchange that is prone to errors.

## Complexity in basic cars - Seat Ateca SUV has 2,2 km of wire, 100 sensors, and control units

Cars have been evolving with increasingly complex circuitry. Seat's Ateca crossover features a complex arrangement of wires more than 2,2 km long. The wires, ranging from one millimeter to one centimeter in thickness, are behind the car's lighting, sound system or driving assistants such as the blind spot detector. Up to 100 sensors and control units interact with each other whenever a vehicle function is activated.

Models such as the Seat Ateca contain more than 1 350 wires which, when laid out in a straight line, would stretch more than 2 200 meters in length, similar to an airport runway. The wires branch off into more than 30 circuits that "ensure the operation of nearly every car function and transfer power from location to another, just like blood flowing through an organism", said Pedro Manonelles, an engineer at the Seat Technical Centre. Most of the wiring is concentrated in the area of the front instrument panel,



where more than 200 wires form strands of more than four centimeters in thickness.

All the wiring on a car such as the Seat Ateca weighs slightly more than 40 kg.

It takes a team of 20 engineers three years to define the routing of the wires, the power distribution and the data transmission among control units and sensors.

Assistants such as the blind spot detector are an example of how the car's electronic system works. When the driver activates the left turning indicator, a signal travels from the main control unit to the rear mounted radars in a fraction of a second. If there is a car in the blind spot that the driver cannot see, the radars will detect it and activate and send a warning light to the door mirror. Thanks to this alert, the driver knows whether it is safe to change lanes.

Multiple CAN networks are implemented. The current CAN network protocol reduces the complexity of vehicle wiring by replacing direct wiring with a two wire signal network so that device computers and sensors can communicate with each other. There are ideas to replace much of this wiring with an ultra fast central processing unit and bus instead of the current slower distributed processing systems.

Source: [Green Car Congress](#)

Figure 5: In some of today's Seat models there are more than 12 000 wiring combinations; this figure could increase in the future (Source: Seat)

Modern harness design and engineering tools provide an elegant solution to the problems being wrought by automotive innovation. Using tools such as Capital, with high levels of automation, advanced metrics and analytical capabilities, engineers can perform tradeoff studies to optimize materials, component placement, and routing for minimal harness weight, cost, and bundle diameter. Next, modern design tools can automate data transition between engineering teams and even between manufacturers and suppliers. Finally, innovative harness design software suites feature integrated change management tools that ensure all teams are working with up-to-date data. By adopting these solutions, established automotive OEMs and start-ups can better tackle the challenges of the new automotive landscape. ◀

### Authors

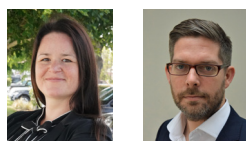

Ulrike Hoff  
Divergent 3D  
[info@divergent3d.com](mailto:info@divergent3d.com)  
[www.divergent3d.com](http://www.divergent3d.com)

Dan Scott  
Siemens Digital Industries Software  
[info@siemens.com](mailto:info@siemens.com)  
[www.siemens.com](http://www.siemens.com)

## The first CAN networks in BMW cars

Two years after a point-to-point CAN network implementation, BMW introduced in 1995 a CAN network in star topology connecting five electronic control units (ECUs).



(Source: BMW)

BMW used already in 1993 in its 740i/iL model a 500-kbit/s CAN network linking the DME and EGS control units supplied by Bosch. The bus system substituted multiple serial links between these ECUs. This reduced cabling and avoided connection failures. Of course, it saved weight, too.

In 1995, the German automaker equipped its E38 750iL model with a CAN network using a tree/star topology. It connected five ECUs: DME I, DME II, AGS, DCS, and EML. Three years later, the instrument cluster and the steering-angle sensor were added to the CAN network. The 1999 model of the 750iL was the last BMW car using shielded CAN cables. In the next models just twisted-pair cables were implemented. The wire color was uniform throughout the vehicle: CAN-L was GE/BR and CAN\_H was GE/SW or GE/RT.

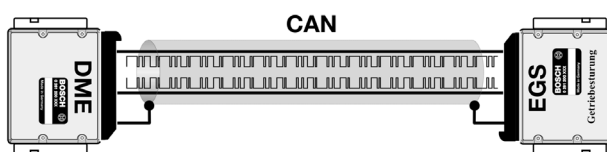

Figure 1: The 740i/iL model from 1993 was equipped with two CAN-connectable ECUs (Source: BMW)

The 120- $\Omega$  termination resistors were located in two ECUs between the CAN\_H and CAN\_L bus-lines. Usually, the resistors were equipped in the ASC/DSC unit and the instrument cluster of the DME unit. Because the two resistors are in parallel, the effective resistance of this termination circuitry is 60  $\Omega$ . On some vehicles, there was a jumper wire, which connected two parallel branches together; others had an internal connection at the instrument cluster.

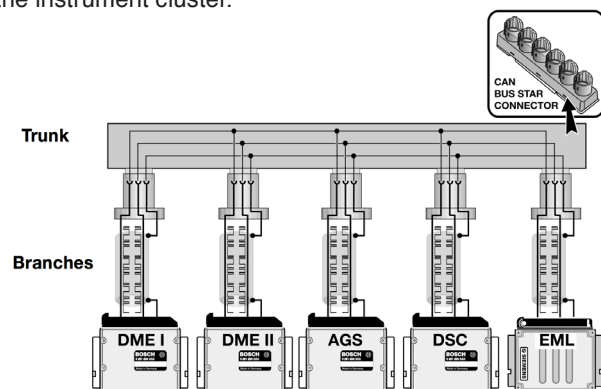

Figure 2: The E38 740iL model from 1995 connected five ECUs to the CAN network (Source: BMW)

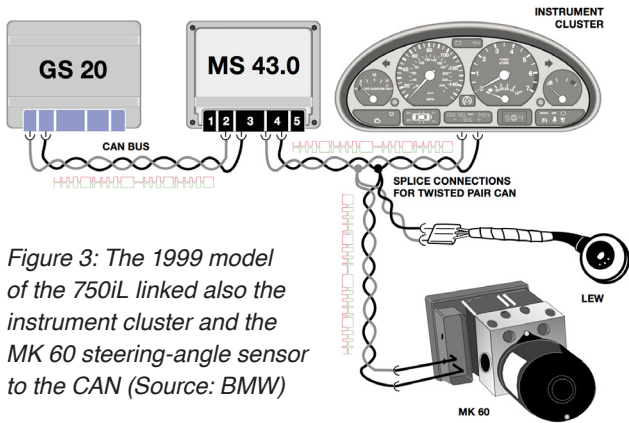

Figure 3: The 1999 model of the 750iL linked also the instrument cluster and the MK 60 steering-angle sensor to the CAN (Source: BMW)

## CAN trouble-shooting was a challenge

In the early days of CAN, network trouble-shooting was something new, challenging the repair and maintenance staff. It was done using ohmmeters, voltmeters, and oscilloscopes. Most challenging were sporadic failures. They could be caused due to slowly dropping battery voltage or by a discharged vehicle battery.

A quick check was done by looking to the instrument cluster, whether the shown tachometer and engine temperature values were plausible. Other indicators could be the transmission range or the DSC light. This gave some clues to the communication status of these ECUs. There was also a test module, which could be linked via CAN to the disconnected ECU. Additionally, some ECUs provided a D-Bus (Diagnosis Bus) interface. It was a point-to-point serial bus system running at 9,6 kbit/s, which kinked the tester and the ECU. ◀

*Holger Zeltwanger*

## All you CAN plug

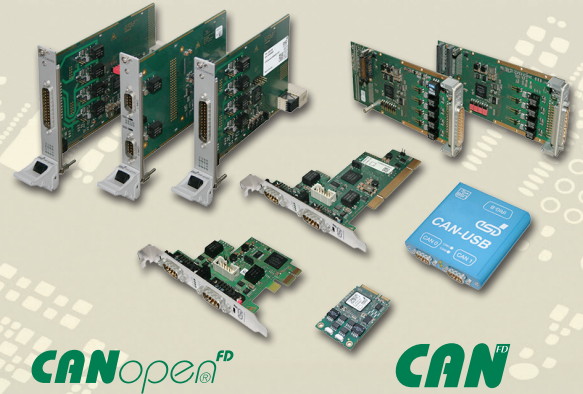

## CAN / CAN FD Interfaces

### Product Line 402 with Highspeed FPGA

- Various Form Factors**  
 PCI, PCI Express® Mini, PCI Express®, CompactPCI®, CompactPCI® serial, XMC and PMC, USB, etc.
- Highspeed FPGA Design**  
 esdACC: most modern FPGA CAN-Controller for up to 4 channels with DMA
- Protocol Stacks**  
 CANopen®, J1939 and ARINC 825
- Software Driver Support**  
 Windows®, Linux®, optional Realtime OS: QNX®, RTX, VxWorks®, etc.

*Quality Products -  
Made in Germany*

### esd electronics gmbh

Vahrenwalder Straße 207 | D-30165 Hannover  
 Tel.: +49(0)511 372 98-0  
 info@esd.eu | www.esd.eu

### esd electronics, Inc.

70 Federal Street - Suite #2  
 Greenfield, MA 01301  
 Phone: 413-772-3170  
 www.esd-electronics.us



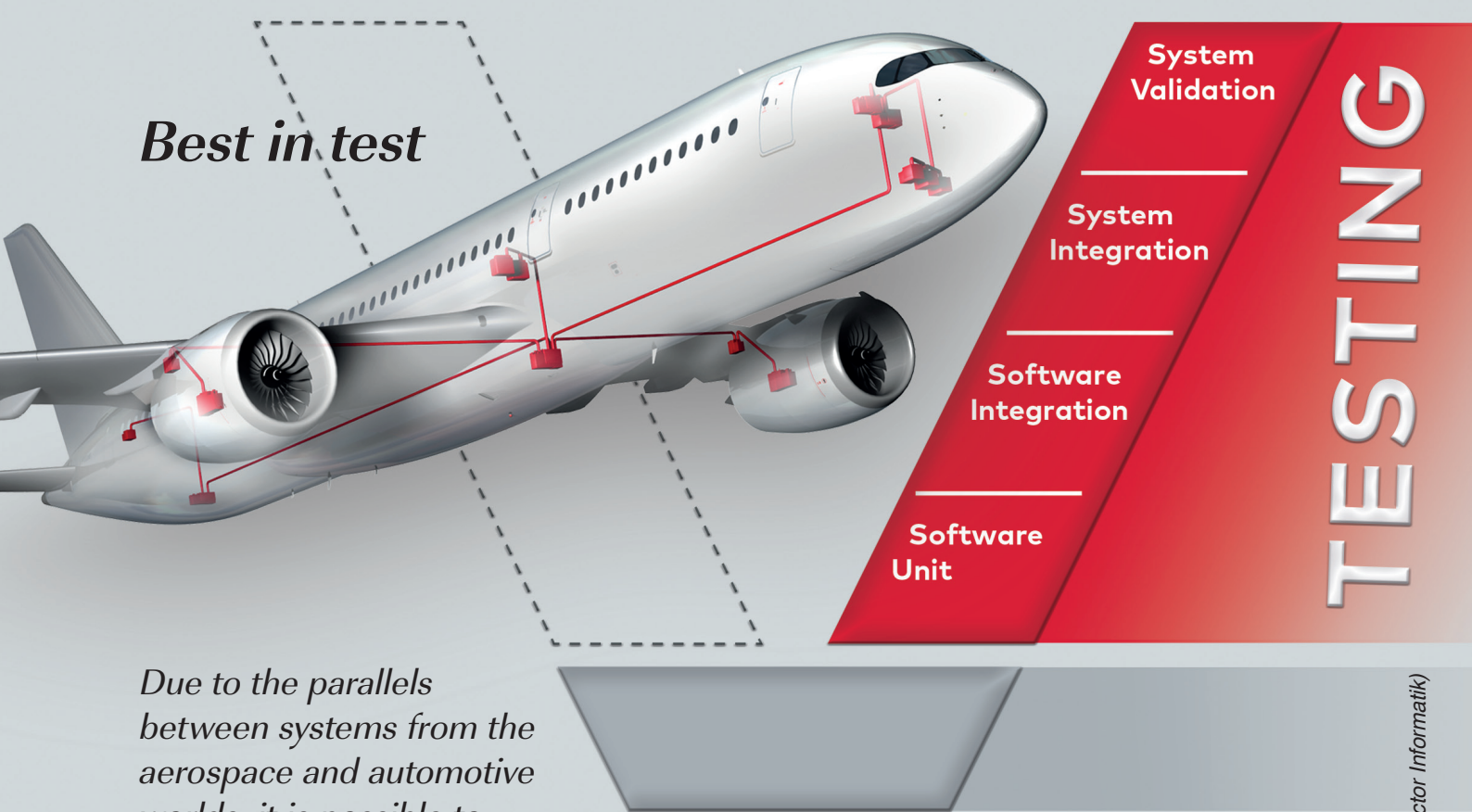

*Best in test*

*Due to the parallels between systems from the aerospace and automotive worlds, it is possible to transfer proven concepts and processes from the automotive industry to avionics. Vector describes it's approaches and concepts.*

(Source: Vector Informatik)

Continued development of comprehensive and structured testing methods and tools for electronically networked aircraft and cabin systems is not only necessary for economic reasons. With the recent safety-critical pilot assistance systems such as Enhanced Vision and Runway Overrun Protection Systems or with "wireless" cabin functions each requires appropriate testing strategies that are compliant to the regulatory rigors assigned to them (i.e. DO-178C). This article describes Vector's approaches and concepts.

The software in avionics and ground-based systems are bounded by strong regulatory standards DO-178C and DO-278 respectively. With failure regarded as "not an option", significant analysis and effort is put into the verification and validation of these systems. In fact, industry wide, in a typical project fifty percent of the development budget is used for structural testing the software according to Federal Aviation Administration (FAA) DO-178C Level A [1]. The ability to automate and simulate these systems can greatly assist in reducing the overall effort, and hence the implementation costs.

There are three major phases of verification and validation in avionics and ground-based software (Figure 1): unit testing, integration testing, and system/functional testing. In each phase, test cases need to be derived from their appropriate level of requirements with full traceability between both.

While the concepts and methodologies for low level testing have been reasonably consistent over the years, the introduction of more networked systems based on the CAN

and AFDX protocol, and the drive for code reuse, demands innovations in the approach as to how the software should be tested. To find good solutions, other industries can be considered that have successfully deployed complex networked systems, with rapid time to market demands and highly critical functionality. An example is the automotive market, with its drive by wire systems, autonomous vehicle technology, 18 to 24 month development cycle and CAN/Ethernet networked platforms.

The similarities in particular in CAN-based systems make it possible to transfer proven concepts and processes from the automotive industry into the avionics domain. CAN is currently used in modern civil aircrafts like A350 and Boeing 787 for systems such as environmental control, doors, galleys, smoke detection, potable water, and de-icing. Furthermore young companies acting in the emerging market of hybrid and full electric air vehicles for new urban air mobility concepts rely on CAN-networks as well.

Due to the specific challenges like long cables, extreme environmental conditions, stringent lightning protection requirements, and long service life, adequate test strategies at all test levels must be foreseen.

The approaches can be considered at three levels as described in section 6.4.3 of the DO-178C standard: low level testing, software integration testing, and hardware/software integration testing. Finally, it is worth considering how these can be coupled into a process which provides greater agility as well as introducing shift-left strategies into the development process. ▶

## Low-level testing

This testing level is used to test the low-level requirements and is usually accomplished with a series of unit tests that allow the isolation of a single unit of source code. To test a single unit in isolation, a huge amount of framework code such as test drivers and stubs for dependencies (Figure 2) must be generated. Ideally, this should be done automatically with a tool that offers an intuitive and simple approach for defining test scenarios. This meets the main requirements of section 6.4.2 “requirements-based test selection” and the sub-sections “normal range test cases” and “robustness test cases” of the DO-178C standard. With the growing need for code reuse, it is very likely the same unit of source code might be used in several configurations. Therefore, it is important that the definition of a test case is not tightly coupled to the code and provides flexibility in how they can be maintained as the software evolves over time. Typically, the use of a data driven interface for the definition of test cases has proven to be more maintainable over time than a source code definition.

This approach also means that when the source code and associated test cases are deployed in a continuous delivery workflow, as changes are made to the code, the testing framework can quickly be regenerated and the test cases appropriately remapped. Where significant changes have been made, these can be flagged for further review without breaking the rest of the automated workflow.

A good example of this is the embedded software testing platform Vectorcast, that automates testing activities across the software development lifecycle. It fully supports testing on target or using the target simulator normally provided by the compiler vendor. Structural coverage from testing isolated components can be combined with the coverage gathered during full integration testing to present an aggregated view of coverage metrics.

Vectorcast test cases are maintained independent of the source code for a data-driven test approach. This technique allows tests to be run on host, simulator, or directly on the embedded target in a completely automated fashion.

## Software integration testing

Software integration testing verifies the interrelationship of components. This concept is also known as software-in-the-loop (SIL) testing. The idea here is to bring the software components together and test them without any of the complexities of the underlying hardware. A critical aspect of testing software during this phase is the ability to simulate dependencies and interfaces in the integrated unit that is under test.

To simulate this software conveniently, it is common to use a host-based compiler like Visual Studio, GCC, MinGW, etc. to run the code, and then once a level of confidence has been achieved, the cross-compiler can then also be used. Depending on the certification level for DO-178C in Level C, B or A, certification credit for the activity may only be permissible when done using the cross-compiler and running on the target.

In the low level testing framework, the collection of software units can still only be tested via programming ▶



# CiA

CAN in Automation



- ▶ *Read*
- ▶ *Write*
- ▶ *Advertise*

## Publications

**CAN Newsletter magazine**  
[www.can-newsletter.org/magazine](http://www.can-newsletter.org/magazine)

- ▶ Technical in-depth articles
- ▶ Market trends
- ▶ Detailed application reports

**CAN Newsletter Online**  
[www.can-newsletter.org](http://www.can-newsletter.org)

- ▶ Product news
- ▶ Brief application reports
- ▶ Tool news

**CiA Product Guides**  
[www.cia-productguides.org](http://www.cia-productguides.org)

- ▶ CANopen & J1939 services
- ▶ CAN tools & devices
- ▶ Protocol stacks

*From experts to experts:  
Address the CAN community  
with your contributions.*

[publications@can-cia.org](mailto:publications@can-cia.org)

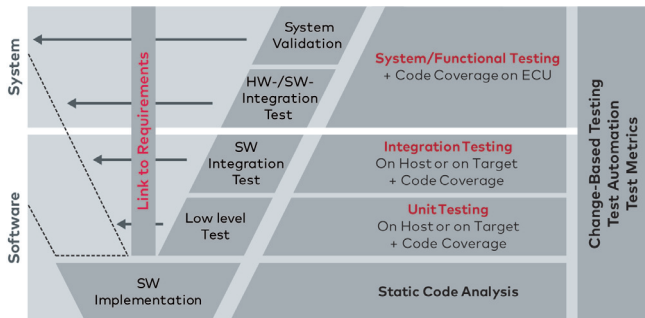

Figure 1: The major phases of verification and validation in avionics and ground-based software (Source: Vector Informatik)

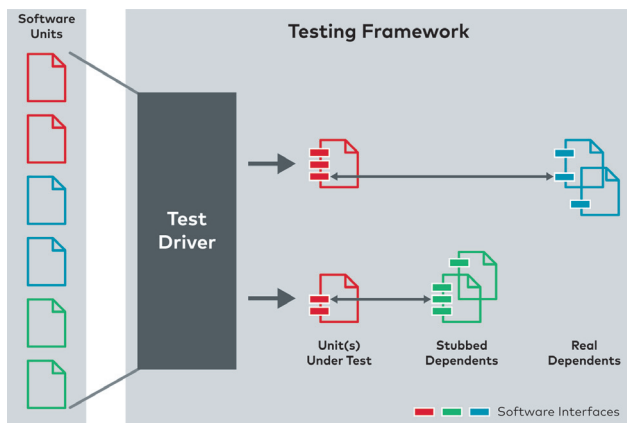

Figure 2: Low level testing framework to test a single software unit in isolation – using framework code such as test drivers and stubs for dependencies (Source: Vector Informatik)

API calls. In this case the use of a test automation framework like Vectorcast is ideal, as it will automatically build the required drivers and stub any units that are outside the units of interest automatically. There could also be an opportunity to reuse some of the test cases from low level testing for units that are higher in the call tree.

Alternatively, the software components to be tested may be closely reliant on the underlying hardware, and a more robust simulation of the underlying hardware is required to correctly verify the software functionality in this case.

### Hardware/software integration testing

This type of testing is used to satisfy high level requirements and is performed on the target hardware using the complete executable image. The challenge when testing at this level is to provide enough external stimulation to the line replaceable unit (LRU) such that it functions correctly. The external simulation comes in various forms: logical pins, avionics data network, modeling tools, etc. Additionally, because of the complex nature of the networks, it should also be possible to easily extend or customize the simulation interfaces quickly and easily.

An example system to validate an LRU at this level can be setup using the tools VT System and CANoe (Figure 3). The software and hardware combination CANoe and VT System from Vector offers a test system that can be scaled from simple test equipment at the developer workstation to

the highly automated HiL environment in the test lab. The core idea of the VT System is to combine all the hardware functions required for LRU testing in a modular system seamlessly integrated into CANoe. The test hardware covers the inputs and outputs, including the power supply and network connections of a control unit or subsystem. At each pin, the pin function according to stimulation, measurement, load simulation, fault connection, and switching between simulation and original sensors and actuators are possible. These functions are so universally designed that a once constructed test system can be used for different LRUs.

In CANoe, in addition to the network environment, the physical environment can also be simulated using appropriate Matlab / Simulink models. A closed hardware-in-the-loop simulation is just as possible as a simple, manual stimulation without elaborate models. CANoe offers the same flexibility in test automation. The tool Vteststudio provides a modern authoring tool. The possibilities to define tests range from programming in various languages like the Vector own Capl and .NET/C# over defining simple test procedures in tabular form to graphically noted test models. It is used to define test procedures and allows the developer to flexibly combine the different input methods. ▶

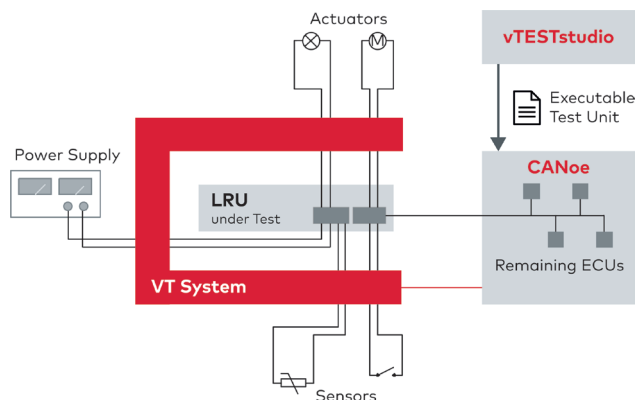

Figure 3: Example setup for simulating the environment around an LRU (Source: Vector Informatik)

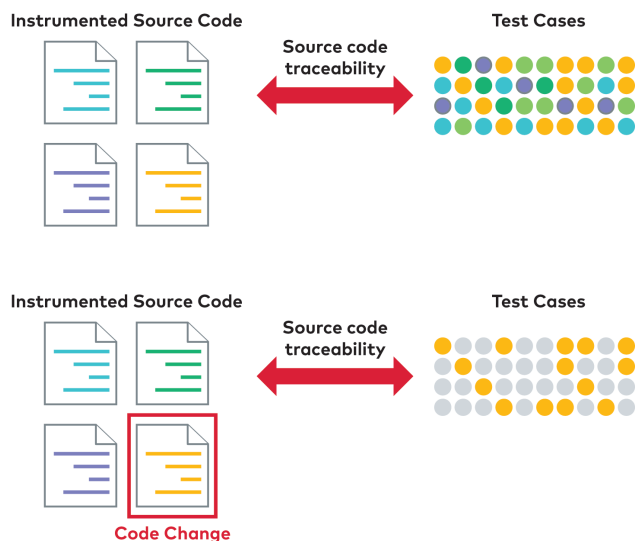

Figure 4: Change-based testing greatly reduces testing time while ensuring testing completeness (Source: Vector Informatik)



The finished test sequences are stored as test units and are then executed in CANoe.

CANoe executes the test cases and at the end of each test run the system creates a detailed test report. Finally, all threads from test and execution planning to execution documentation converge in test data management. This always ensures good traceability.

## Bring it all together to enable a lean continuous integration platform

One of the biggest challenges with software development today is the unintended propagation of defects or issues through the development cycle of a system. These issues can often be identified very early in the development cycle but are missed because the software is merged without the adequate verification and validation in place. To address this quality issue, there are various discussions on the topic of 'shift left', i.e. test earlier in the process. However, in general the time required to rerun all low level, software integration, and hardware/software integration tests can be very time consuming. In some cases, a complete end to end run of all test cases can take between three weeks to as long as two months. This time frame does not fit the rapid feedback that is required to provide developers with early feedback of issues that they might have introduced at the time of writing the software.

To address this challenge, the concept of change-based testing (CBT) can be introduced. This method helps organizations test faster and smarter by analyzing each code change against all existing test cases and choosing the sub-set of tests that are affected by the change (Figure 4). By running only this sub-set of tests, test execution times are greatly reduced, and developers get immediate feedback on the impact of their changes. This allows bugs to be fixed immediately, when they are introduced, rather than weeks later, during "full" testing.

By using a test automation platform like Vectorcast, structural code coverage is collected from all levels of testing like low level, software integration, and hardware/software Integration. The ability to integrate the code coverage reporting with software integration and hardware/software integration tools like CANoe and VT System provide a single perspective of the system's aggregated code coverage, and how a specific test directly contributed to the overall code coverage. Thus, when a change is made to the underlying software, the Vectorcast decision engine quickly computes the impacted tests at all levels and dispatches them appropriately – even when the test is to be run through CANoe or VT System. Running a subset of tests represents a significant time saving in the execution time, and shortens the time taken to determine an impact from a change made to a matter of hours with a high level of confidence.

## Conclusion

As the complexities of avionics and ground-based systems continue to evolve, the need to provide more sophisticated strategies and tooling for addressing the compliance required for verification and validation for DO-178C and

DO-278 will continue to grow. The networked aircraft will require the ability to not only ensure that a single LRU functions correctly, but all LRUs also function correctly when the entire system is brought together. This means that the ability to isolate components at a software unit level, as well as a LRU level while simulating the remaining interfaces will be critical to achieving the quality requirements of the avionics industry. Furthermore, the artifacts from the verification and validation activity can be integrated into a continuous integration process to introduce modern 'shift-left' concepts into the development of safety critical systems while ensuring compliance to the standards. ◀

## References

- [1] <https://www.vectorcast.com/customers/testimonials/lockheed-martin-uses-vector-software-vectorcast-ada-c130j-do-178b-testing>



## Authors

Dr. Arne Brehmer, Hans Quecke  
Vector Informatik  
[info@vector.com](mailto:info@vector.com)  
[www.vector.com](http://www.vector.com)

## Scalability of CANopen

*When price matters, scalability is an important feature for embedded and deeply embedded networks. Although CANopen FD is not completely compatible with classic CANopen, scalability is provided.*

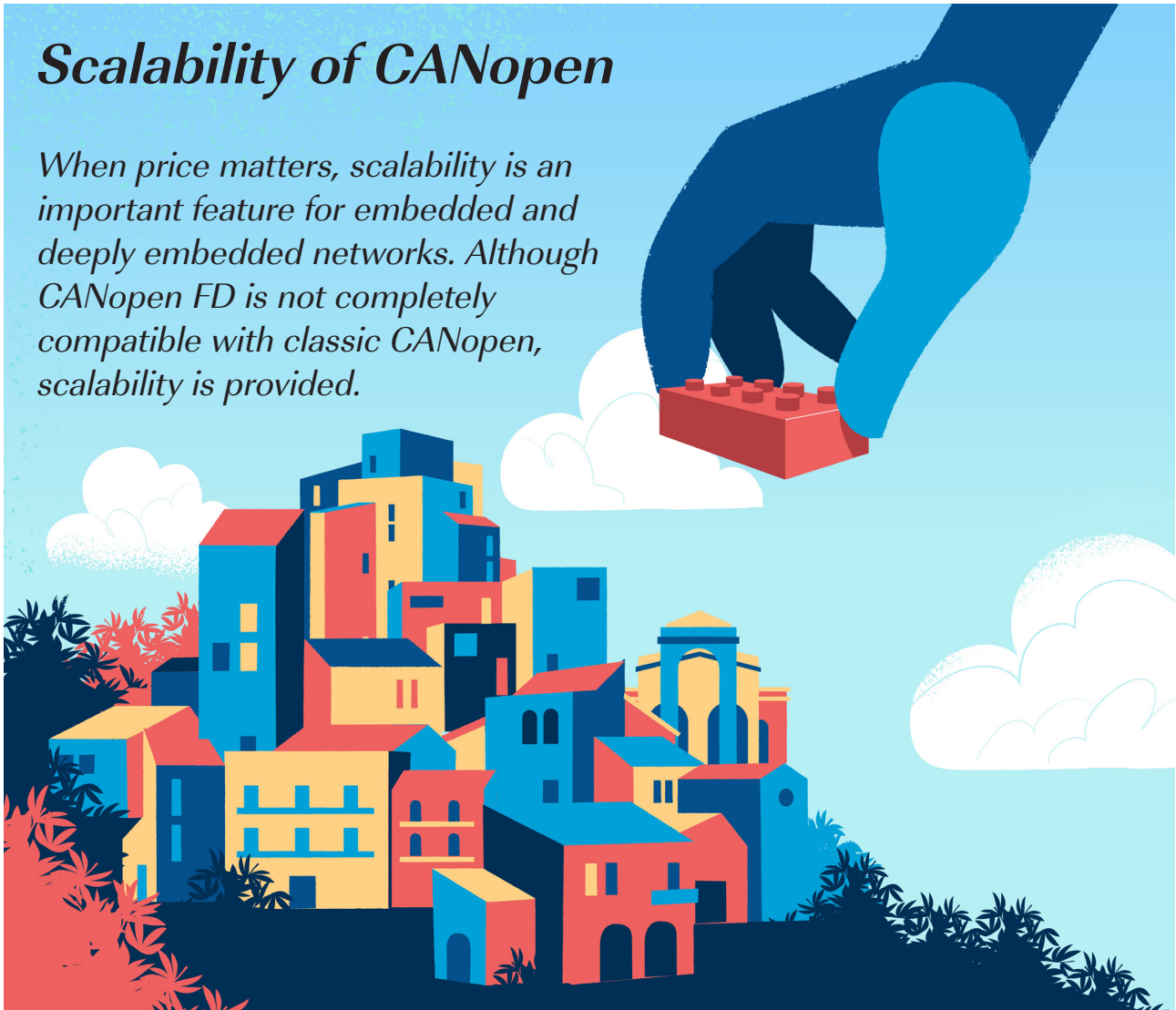

(Source: Adobe Stock)

Classic CANopen embedded networks are used in a very broad range of application fields: Just have a look into previous issues of this magazine and its [online sister publication](#). You will find reports about CANopen in satellites, in subsea, any kind of vehicle, and many motion-control applications. Additionally, CANopen has migrated into deeply embedded networks such as backbone networks, in industrial I/O devices, and in smart devices with multiple sub-modules. CANopen introduced already in 1994 offered from the beginning scalability not only regarding communication functionality.

Some people still think that CANopen is complex. No, it is not. It provides just a few mandatory features (NMT, Heartbeat, and expedited SDO functionality), and a lot of optional add-on communication functions (PDO, normal SDO, SYNC, TIME, and EMCY as well as “Flying” NMT master functionality), if needed. This is like in a restaurant: the menu lists more dishes than you can eat.

Regarding the bit-rate, CANopen allows eight standardized bit-rates; from 10 kbit/s to 1 Mbit/s. Other communication technologies do not support those much different bit-rates. But consider: The higher the speed, the more challenging is the physical network design. This means the costs for cabling, connectors, and energy consumption increase with the higher bit-rates.

On the other hand, data throughput requirements are increasing permanently with new control functions. Of course, you can spend some effort to communicate smartly, not wasting the available bandwidth. For example, do not talk, if you have no new data. But at some point you need more throughput. The limit for classic CANopen is 1 Mbit/s, when your network is not longer than 25 m and only very short not terminated stubs are installed.

### CANopen FD for higher bit-rates

CANopen FD is based on the CAN FD data link layer. Depending on the bus-line topology you can achieve 2 Mbit/s in the data-phase. If you need more, you should implement the so-called SIC (signal improvement circuit) transceiver as specified in CiA 601-4 version 2.0.0. Up to 8 Mbit/s is possible, when the topology is as close as possible a bus-line and the impedance of the installed components matches 120 Ohm. For more details on SIC transceiver, see the [article on page 4](#).

In some applications, the busload is not the restriction. It's the 8-byte payload limit, which matters. CANopen FD features because of the used CAN FD data link layer a maximum data frame length of 64 byte. Unfortunately, the length is not byte-wise increasable. The longer data ▶

frames can be used to add cybersecurity or functional safety headers/trailers. This means your network can be scaled regarding security and safety requirements without changing the normal process data communication.

In case, you do not need higher bit-rates than 1 Mbit/s, you can use in arbitration and data-phase the same bit-timings. Depending on the chosen topology, it could be that you should implement different sample-points.

As said above, higher data-rates require a more precise development of the physical network. This means, try to avoid communication of redundant data. This reduces the busload allowing the use lower bit-rates.

*Table 1: Classical CAN bit-rates, which also can apply for the arbitration bit-rate in CANopen FD, but the sample-point shall be set to 80 %*

Bit-rate [kbit/s]	Max. network length [m]	Sample-point [%]
1000	25	75 to 90
800	50	
500	100	85 to 90
250	250	
125	500	
50	1000	
20	2500	
10	5000	

*Table 2: CAN FD dataphase bit-rates using an 80-MHz clock frequency*

Bit-rate [Mbit/s]	Sample-point [%]
10	62,5
8	60
5	62,5
4	70
2	75
1	80

## Optimized PDO communication

The classic CANopen and CANopen FD application layers are designed to support scalable PDO (process data object) communication. The PDO protocol allows the transport of 1-byte messages up to 8-byte (classic CANopen) respectively 64-byte (CANopen FD) messages. For messages with more than 8 byte the scalability is not byte-wise, but with some jumps: 12, 16, 20, 24, 32, 64 byte. If not the entire payload is needed, so-called padding bytes need to be used.

Regarding the PDO scheduling both application layers support periodical, change-of-state, and synchronized transmission. And the best is, you can mix them in the network. Combined with the option to configure PDO cross-communication between NMT slave devices, the system designer can scale the PDO communication to the application needs. This means you can start with simple “master/

slave” communication scheme and end-up with a highly optimized PDO communication. Sophisticated CANopen system design tools can do this optimization.

## From SDO to USDO

Scalability of SDO (service data object) communication was already provided from the beginning. Expedited SDOs enable to read or to write parameters with a maximum length of 4 byte in the object dictionary of another device. Using the normal SDO protocol, the length of the parameters is not limited. In order to accelerate the SDO transport protocol, the SDO block transfer was introduced in classic CANopen version 4.0.

CANopen FD supports similar scalability of USDO (universal service data object) communication. Additionally, the USDO protocols can be broadcasted, what is not possible with SDOs. In the near, future also multi-parameter transmission will be possible with USDOs. A typical application is the PDO mapping configuration with one USDO. In the past, you needed for each PDO mapping parameter individual SDO/USDO messages. The single message approach avoids considering configuration inconsistency caused by SDO communication problems.

## From simple to complex networks

Classic CANopen and CANopen FD are designed to support scalability. You can start with a simple network, just using expedited SDO/USDO communication. You can add normal SDO/USDO communication and simple “master/slave” PDO messages. If one network is not sufficient, you can design a multi-segment network. Necessary remote access (router function) is already available in the portfolio of the SDO/USDO protocols.

Scalability is an important issue in modern communication systems. Classic CANopen and CANopen FD are very scalable compared to other standardized CAN-based higher-layers such as SAE J1939. The Classical CAN and CAN FD data link layers are backwards compatible, but legacy Classical CAN controllers destroy CAN FD data frames by means of CAN error frames. This means, new protocol controllers supporting CAN FD are necessary. ◀

Holger Zeltwanger

# Don't design - configure!

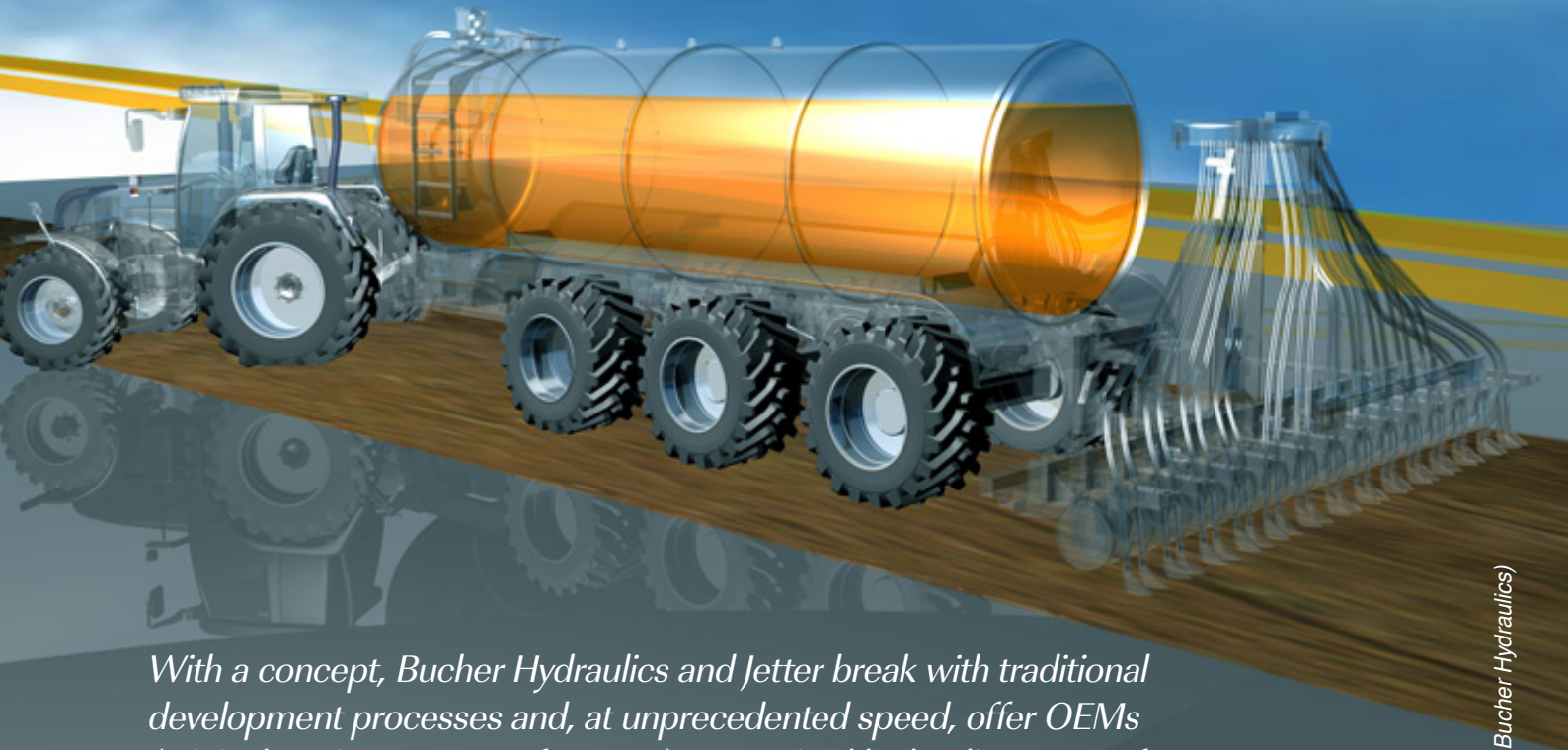

*With a concept, Bucher Hydraulics and Jetter break with traditional development processes and, at unprecedented speed, offer OEMs (original equipment manufacturers) customized hydraulic systems for slurry tankers.*

(Source: Bucher Hydraulics)

Precision farming is generally regarded as the ideal way for the targeted cultivation of agricultural land. For manufacturers of vehicles and implements, however, precision farming also means an increasing number of electronic components, the integration of new sensor technologies, and a number of variants and functions in their range of vehicles. Slurry tankers in particular, both as self-propelled and towed versions, represent a major challenge in terms of development costs and time. This is because a large number of possible options in the chassis, steering system, and slurry tank, as well as different distribution devices, must be catered for. The Nitrates Directive 91/676/EEC on groundwater protection and its German implementation in the form of the Fertiliser Ordinance (DüV) are also hovering over the industry as a constant worry. It is uncertain how long this will remain just a matter of stricter documentation obligations and tighter rules for determining fertilizer requirements, as well as longer 'no fertilizing' freeze periods. The industry is therefore facing the additional challenge of being able to react quickly to statutory regulations at the same time that the number of variants for slurry tanker subsystems is increasing. Significantly shorter development cycles for hydraulic systems and their control, as well as retrofit solutions, are currently very important for slurry tanker manufacturers.

## Generic modular development

The approach of Bucher Hydraulics and Jetter has been to completely end the "serial" development process that starts with requirements specifications, then project planning, engineering, prototype procurement, test phase, and initial sampling: The design of the system solution was broken down into a number of individual modular solutions, taking into account all common variants and technologies on the market. This was true for both the hardware and the software aspects. For this purpose, an interdisciplinary team of Bucher and Jetter engineers defined more than 40 hydraulic subfunctions for the slurry tanker. For each subfunction (e.g. suction hose), the corresponding variants (e.g. multi-jointed suction arm) were assigned to it and the hardware and software elements for each of these variants were then developed and tested. A good 1,5 man-years was invested just in the source code for all the options. The "generic system solution for slurry tankers" contains around 1 400 parameters. Each specific overall system for a particular slurry tanker now consists of a combination of selected and previously tested and optimized subsystems.

Bucher Hydraulics has the right portfolio for a modular configuration of the hydraulic system, because the control blocks feature a sectional design. With up to 22 sections, ▶

# Register now!

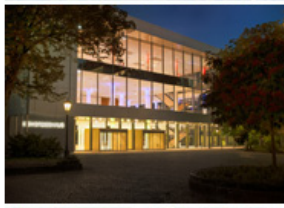

Meet and discuss latest CAN-related solutions with CAN experts  
 March 17 to 18, 2020  
 Register at [www.can-cia.org/icc](http://www.can-cia.org/icc)

## Tuesday, March 17, 2020

09:30 - 09:45	Holger Zeltwanger (CiA)	Conference opening
<b>Keynote session</b>		
<b>Chairperson: Holger Zeltwanger (CiA)</b>		
09:45 - 11:00	Carsten Schanze (VW)	Future of CAN from the prospective of an OEM
<b>Session I: Physical layer</b>		
<b>Chairperson: Carsten Schanze (VW)</b>		
11:00 - 11:30	Magnus-Maria Hell (Infineon)	The physical layer in the CAN XL world
11:30 - 12:00	Patrick Isensee (C&S Group)	The challenge of future 10-Mbit/s in-vehicle networks
12:00 - 12:30	Johnnie Hancock (Keysight)	Characterizing the physical layer of CAN FD
12:30 - 14:00	Lunch break	
<b>Session II: CAN XL data link layer</b>		
<b>Chairperson: Reiner Zitzmann (CiA)</b>		
14:00 - 14:30	Florian Hartwich (Robert Bosch)	Introducing CAN XL into CAN networks
14:30 - 15:00	Dr. Arthur Mutter (Robert Bosch)	CAN XL error detection capabilities
15:00 - 15:30	Dr. Christian Senger (University of Stuttgart)	CRC error detection for CAN XL
15:30 - 16:00	Coffee break	
<b>Session III: CANopen testing</b>		
<b>Chairperson: Uwe Koppe (Microcontrol)</b>		
16:00 - 16:30	Mark Schwager (Vector)	A new approach for simulating and testing of CANopen devices
16:30 - 17:00	Oskar Kaplun (CiA)	CANopen FD conformance testing – today and tomorrow
<b>Session IV: CANopen FD</b>		
<b>Chairperson: Christian Schlegel</b>		
17:00 - 17:30	Uwe Wilhelm (Peak), Christian Keydel (Emsa)	A simplified classic CANopen-to-CANopen FD migration path using smart bridges
17:30 - 18:00	Alexander Philipp (Emotas)	A theoretical approach for node-ID negotiation in CANopen networks
18:00 - 18:30	Yao Yao (CiA)	CANopen FD devices identification via new layer setting services (LSS)

## Wednesday, March 18, 2020

<b>Session V: CAN FD lower layers</b>		
<b>Chairperson: Dr. Frank Deicke (Fraunhofer IPMS)</b>		
09:00 - 09:30	Tony Adamson (NXP)	CAN signal improvement and designing 5-Mbit/s networks
19:30 - 10:00	Fred Rennig (ST Microelectronics)	A lightweight communication bus based on CAN FD for data exchange with small monolithic actuators and sensors
10:00 - 10:30	Kent Lennartsson (Kvaser)	Improved CAN-driver
10:30 - 11:00	Coffee break	
<b>Session VI: Engineering</b>		
<b>Chairperson: Kent Lennartsson (Kvaser)</b>		
11:00 - 11:30	Nikos Zervas (Cast)	Designing a CAN-to-TSN Ethernet gateway
11:30 - 12:00	Dr. Heikki Saha (TKE)	Automated workflow for generation of CANopen system monitoring graphical user interface (GUI)
12:00 - 12:30	Dr. Christopher Quigley (Warwick)	Benchmarking of CAN systems using the physical layer – car, truck, and, marine case studies
12:30 - 14:00	Lunch break	
<b>Session VII: Security</b>		
<b>Chairperson: Torsten Gedenk (Emotas)</b>		
14:00 - 14:30	Thilo Schumann (CiA)	Embedded security recap
14:30 - 15:00	Prof. Dr. Axel Sikora (Hochschule Offenburg), Georg Olma (NXP), Olaf Pfeiffer (Emsa)	Achieving multi-level CAN (FD) security by complementing available technologies
15:00 - 15:30	Vivin Richards, Allimuthu Elavarasu (Infineon)	CAN XL made secure
15:30 - 16:00	Coffee break	
<b>Session VIII: CAN XL higher layers</b>		
<b>Chairperson: Dr. Arthur Mutter (Robert Bosch)</b>		
16:00 - 16:30	Peter Decker (Vector)	IP concepts on CAN XL
16:30 - 17:00	Holger Zeltwanger (CiA)	Multi-PDU concept for heterogeneous backbone networks

## Sponsors





Figure 1: With the LVS hydraulic valve, designers can now create those implement control systems that, so far, have been difficult to master. LVS valve blocks can be configured for both fixed displacement and LS pumps. (Source: Bucher Hydraulics)

all the functions can be incorporated in one block. Alternatively, it is possible to distribute the functions over several blocks, e.g. on the drawbar, distributor or suction boom. The valves with functions specific to the slurry tanker also have a sectional design. They operate load-independently thanks to the pressure compensator that is connected downstream of the proportional directional control valve (flow-sharing principle). A very large selection of valves is available for special functions in the areas of steering, chassis, hitch, top cylinder, etc., which can be combined modularly in a variety of forms in the inlet or intermediate sections.

Table 1: A selection of some already implemented functions (Source: Bucher Hydraulics)

Chassis functions	Steering system	Distribution attachments
Articulated drawbar	Tire pressure control system	Disc harrow
Articulated drawbar	Compressor prerun and overrun, intervals	Baffle plate
Hitch control	Compressor fan overrun	Strip tillage
Hydraulic suspension	Top cylinder	Drag shoe
Centralized lubrication system		Drag hose

The proportional valves, e.g. for steering or for controlling the application rate, can be combined as required in the block. Therefore no particular priority needs to be allocated when arranging the valve positions. This makes variant management much easier. System solutions that include downstream pressure compensators prevent subsystems from stopping in the event of undersupply. This ensures trouble-free, continuous operation even in critical areas such as the headland or when filling the slurry tank. In developing the "generic system solution for slurry tankers", Bucher Hydraulics concentrated primarily on optimizing the control of the valves by the Jetter electronics.

The special feature of the generic system solution: customers can themselves select all the hydraulic and electrical subfunctions in a configuration file (text file). All subfunctions are pre-programmed and customers only have to compile the configuration file for their vehicle or attachment. All standard filling and docking systems, pump and distribution systems, even the NIR (near-infrared spectroscopy) sensor and the Piadin admixture are available as options and can be parameterized. The visualization software for the Isobus terminal and the control software are compiled from the configuration file. For the visualization of the partial functions, the guideline was to use self-explanatory pictograms and to supplement them with relevant data, such as the partial width of the injector, the fill level of the slurry barrel or the height of the hitch, etc. Custom layout options for the display are possible via freely placeable softkeys. This, too, is defined in the configuration file. All precision farming functions based on the Isobus, such as Virtual Terminal, the integration of a tractor ECU (electronic control unit), a freely configurable joystick, Task Controller BAS, the application rate specific to a particular sub-area using Task Controller Section Control, and Task Controller Geo are "on board". The integral user management is particularly important for contractors. Using this function, the jobs that have been loaded from the Task Controller can be assigned to the respective driver. The job data can be transferred to the task controller via telemetry or a USB stick.

### Wiring harness

Each valve block is controlled via an I/O node and the data is looped from I/O node to I/O node via CANopen. The ▶

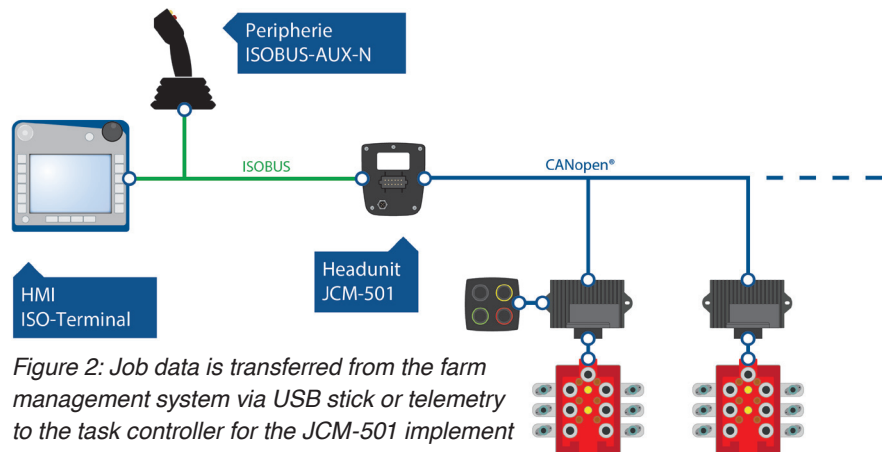

Figure 2: Job data is transferred from the farm management system via USB stick or telemetry to the task controller for the JCM-501 implement ECU (Source: Bucher Hydraulics)

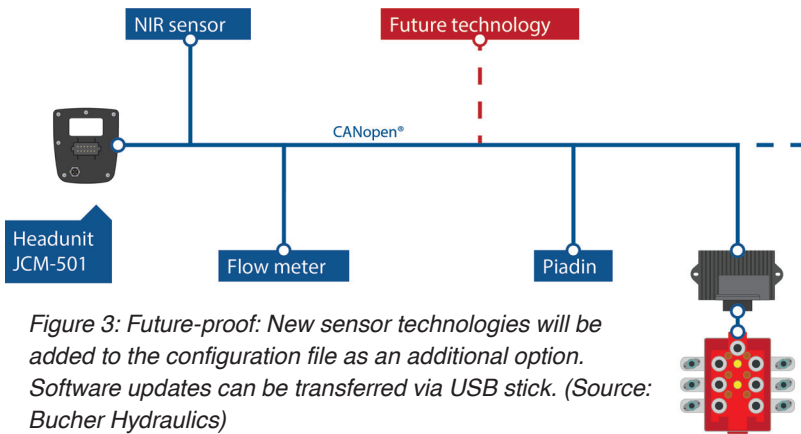

Figure 3: Future-proof: New sensor technologies will be added to the configuration file as an additional option. Software updates can be transferred via USB stick. (Source: Bucher Hydraulics)

classic cable harness is not a practicable solution for such a freely configurable system with its numerous options. With a central electrical system and cable distributors, flexible and plug & play cabling with high-quality connector systems is offered (cable distributors: IP67 unplugged, IP69K plugged in, IP65 central electrical system with cable glands).

During commissioning, the cabling, plug connections, sensors, and switches are checked by an input and output test at the terminal. In the event of a fault in the field, integral diagnostics make it easier to locate electrical faults such as cable breaks, faulty plug connections, and short circuits.

Some German states have recently also approved the use of an NIR sensor to determine the slurry dosage via nutrient amounts. The NIR sensor is connected to the controller via CAN network and provides the nitrate, phosphate, and potassium content in the slurry. The correct application rate is controlled by the nitrogen value measured in the slurry, and the phosphate and potassium values during application (geo-referenced) are recorded in the Task Controller.

For OEMs, this generic system solution for slurry tankers means a radical change in development and in the communication with their suppliers of hydraulics and control systems. In the beginning phase we no longer have the sometimes tedious preparation of a requirements specification, instead we have a configuration tool for the hardware and software. This covers all the important functions

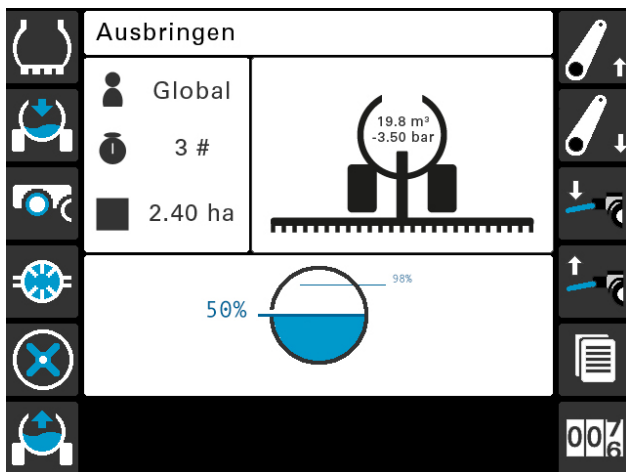

Figure 4: All active functions at a glance – visualization at the terminal (Source: Bucher Hydraulics)

of the slurry tanker. The OEM can concentrate on the placement of the hydraulic components and their piping, the connection of the central electrical system, and the linking of the I/O nodes, sensors, and switches. The plug & play cables are supplied with the system. Future sensor technologies will be implemented as a new option in the relevant module in the control software and visualization. The NIR sensor and the Piadin admixture have already been included in this way. OEMs can now face any future tightening of the Fertiliser Ordinance with composure.

Bucher Hydraulics stated: "Our contribution to precision farming is to bring together into a system all the components ranging from hydraulics, through solenoids, sensors, controls, display, visualization, and programming all the way to diagnostics in a highly flexible, customer-specific manner and with maximum speed-to-market. This enables OEMs to react quickly and flexibly to customer requests and new legal requirements." "We took Isaac Newton as our role model and systematically divided the complex problem into small, easily solvable subproblems and then brought those together again to form the overall solution." ◀

#### Contact

Jetter  
[info@jetter.de](mailto:info@jetter.de)  
[www.jetter.de](http://www.jetter.de)

Bucher Hydraulics  
[info@bucherhydraulics.com](mailto:info@bucherhydraulics.com)  
[www.bucherhydraulics.com](http://www.bucherhydraulics.com)

## Sensor fusion: Inertial measurement units

An IMU embeds several sensors on the same physical device. Combined sensor data tailored for a certain application is available on a CAN interface. This unburdens the CAN network from additional traffic and allows a simpler network design.



(Source: Adobe Stock)

An inertial measurement unit (IMU) is an electronic device that measures and reports a body's specific force, angular rate, and orientation. It works by detecting linear acceleration using accelerometers and rotational rate using gyroscopes. Some IMUs also include a magnetometer, which is commonly used as a heading reference. Such IMU configurations contain one accelerometer, gyroscope, and magnetometer per axis for each of the three vehicle axes: pitch, roll, and yaw. As a rule, an IMU is equipped with a CAN interface. On the market devices with 9 DOF (degree of freedom) or 6 DOF (without magnetometers) are available. IMUs are essential components in robotics, diverse vehicles, manned and unmanned aircraft (e.g. drones), spacecraft, satellites, ships, submarines, etc.

Included in GPS (global positioning system) devices an IMU allows a GPS receiver to work when GPS signals are unavailable e.g. in tunnels, inside buildings or when electronic interference is present. The IMUs are often incorporated into inertial navigation systems (INS), which use the IMU data to calculate attitude, angular rates, linear velocity and position relative to a global reference frame. Thus, INS form the backbone for the navigation and control of many commercial and military vehicles. Simpler INS versions termed AHRS (attitude and heading reference systems) utilize IMUs to calculate vehicle attitude with heading relative to magnetic north. Here, the data collected from the IMU's sensors allows a computer to track a craft's position, using the so-called dead reckoning method.

In land vehicles, an IMU may be integrated into GPS-based automotive navigation systems or vehicle tracking systems. This gives the system a dead reckoning capability and the ability to gather data about the vehicle's current speed, turn rate, heading, inclination, and acceleration. In combination with the vehicle's wheel speed sensor output

and the reverse gear signal the IMU data is used for traffic collision analysis.

IMUs serve as orientation sensors in smartphones and tablets. They are also used to measure motion in sport technology (e.g. fitness trackers), remote controls for gaming systems, and animation applications. The IMU is essential in the balancing technology used in the Segway personal transporters. Low-cost IMUs have enabled the proliferation of the consumer drone industry.

### IMUs in unmanned aerial vehicles

In unmanned aerial vehicles typically the 9-DOF IMUs are used. An IMU measures the inertial quantities of a vehicle as accelerations and angular velocities. The measured values may be used for automatic feedback control loop or processed to estimate the attitude (roll, pitch, yaw or quaternion) of the vehicle. Accelerometers sense all applied accelerations also those due to vibrations or maneuvers. Thus, isolation and an accurate calibration are important. Gyroscopes measure the rotational velocity around their axis. This value may be used to estimate actual tilt angle and serves as a signal for feedback control loops e.g. for stabilization of RC helicopters.

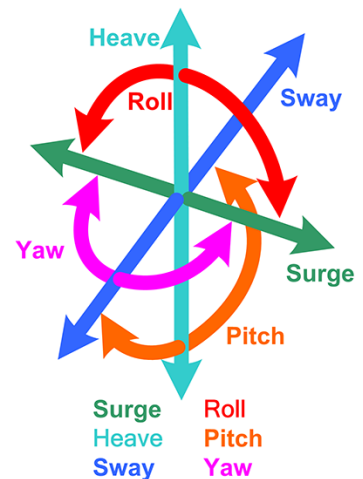

Figure 1: Six degrees of freedom (Source: Honeywell)





Figure 2: Openimu300ri IMU for a wide range of applications (Source: Anceinna)

Gyroscopes should be calibrated before each vehicle starting. A magnetometer measures the local magnetic field components, which may be compared with the world magnetic field model in order to estimate the attitude, and thus the heading respect to the local magnetic North. As the local magnetic field is easy to affect (e.g. by electric lines, sun activities, or other sensors) the local declination has to be considered while measuring.

### More safety for autonomous vehicles

In an autonomous vehicle, CAN is used to pass IMU data to the main vehicle control and to share it with other vehicle sub-systems such as lidar, camera, radar, etc. The IMU application may also listen to other messages on the network. For example, the dynamic tilt algorithm supported by the IMU could be performance-enhanced by listening to messages such as odometer or vehicle speed to better compensate for the influence of linear acceleration on dynamic roll and pitch.

One of the CAN-enabled 9-DOF IMUs is the Openimu300ri by Anceinna. The Mems-based (micro electro-mechanical system) device also provides an EIA-232 interface. The ARM Cortex M4 CPU (central processing unit) runs standardized and customized algorithms created with the company's free, open-source developer tool-chain. In the INS navigation application, GPS sensor data inputted via the EIA-232 interface is fused with the IMU data for the GPS/INS sensor fusion. The IMU supports 11-bit and 29-bit CAN-Identifiers. Consumer automobiles often use customer-defined messages with 11-bit CAN-identifiers, whereas heavy-equipment vehicles more commonly use the 29-bit CAN-identifiers and define messages according to the J1939 standard. The IP67-rated IMU is designed for use on 12-V and 24-V vehicles.

INS and GNSS (global navigation satellite system) developers not familiar with CAN may use a CAN analyzer to get started with the development. The company provides an open-source Python test application that allows to read

and parse messages from IMU over CAN. A set of messages for accelerations, rates, and other data of an IMU may be defined. A DBC (data base CAN) file is then created to describe the chosen encoding of a CAN message.

The mentioned IMU application may be also used in a J1939 network. It provides the PGN (parameter group number) 61485 and PGN 61482 for acceleration and angular rate respectively. The company also supports a dynamic tilt algorithm, which computes the dynamic inclination (i.e. roll and pitch) by integrating the angular rate sensors to angle and then using the acceleration channels to establish a stable, absolute reference with respect to gravity as well as correct for the long-term drift of the integration process. The J1939 slope sensor 2 information message (PGN 61481) is used to encode dynamic roll and pitch.

The unit is dedicated for autonomous off-road, construction, agricultural, and automotive vehicle applications. It allows engineers to optimize an attitude, navigation or other algorithm for their vehicle or application and to run it in on the IMU. This minimizes communication on the CAN network and unburdens the processor, or allows to use a less expensive processor. The processed IMU data may be used for such applications as keeping a cab level, returning an arm to a specific position, keeping a bucket stable while traveling, locking out control for safety applications, supplementing GNSS data to keep a tractor on course, etc.

### For construction and mobile machines

Honeywell's Tars-IMU (transportation attitude reference system) with 6 DOF is designed for heavy-duty and off-highway transportation applications. The device reports key data required to automate and monitor movements of vehicle systems and components using a sensor fusion algorithm. Communication to the vehicle is carried through a CAN interface with J1939 connectivity. The CAN bit-rate of 250 kbit/s is used. A 120-Ohm termination resistor is not included with ▶

#### Abbreviations used

AGV	automatic guided vehicle
AHRS	attitude and heading reference systems
ASIL	automotive safety integrity level
DBC	data base CAN
DOF	degree of freedom
ECU	electronic control unit
GNSS	global navigation satellite system
GPS	global positioning system
GUI	graphical user interface
HLP	higher layer protocol
ICE	internal combustion engine
IMU	inertial measurement unit
INS	inertial navigation systems
Mems	micro electro-mechanical system
OEM	original equipment manufacturer
PGN	parameter group number
ROS	robot operating system
TARS	transportation attitude reference system
TOF	time-of-flight

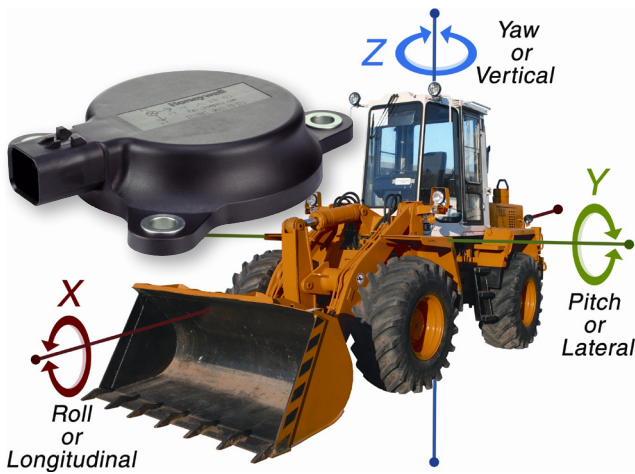

Figure 3: Honeywell Tars-IMU used in a front-loader (Source: Honeywell)

the IMU. With the IP67/IP69K-rated thermoplastic housing and an operating temperature range of  $-40\text{ }^{\circ}\text{C}$  to  $+85\text{ }^{\circ}\text{C}$  it is fitted for use in harsh environments. Two sensor models for 5-V and 9-V to 36-V power levels are available.

Construction vehicle OEMs (original equipment manufacturer) enable the equipment with intelligence and autonomy for certain functions to assist the operator. For example, to dig hundreds of post holes precisely placed in several rows a backhoe with an auger attachment was equipped with the Tars-IMU. In this project, the unit monitored vehicle and implement positions. In addition, it measured the alignment with the ground. An on-board system and graphical user interface (GUI) compared the information coming from the IMU and the site plan for the required holes. This allowed the operator to drive to a hole location, align the tool to specification, and dig the hole to required depth. According to the IMU supplier, construction industry moves toward fully-autonomous systems.

When designing systems for off-highway vehicles (e.g. wheel loaders), engineers need to know how the vehicle reacts in a given loading and movement situation. When installed on a vehicle, the Tars-IMU reports if a vehicle is turning, moving uphill, tilting about its lateral axis, and accelerating. This information serves as an input to systems monitoring traction and vehicle output. For example, an operator has applied power to move the vehicle. This signal is controlled and relayed by the vehicle's electronic control unit (ECU) to the engine to provide power to the drivetrain and to move the wheels. Meanwhile, the IMU is sensing the vehicle's movement. If the signal from the IMU does not match with the ECU-expected vehicle movement, it could be interpreted as a traction loss or as a wheel slippage event. If programmed to automatically reduce power to the wheels on such an event, the system could limit the incidents of wheel slippage. In some cases, wheel slippage on previously worked surfaces and ground may quickly require costly rework. The manufacturer also offers the CAN-capable 6-DOF IMU sensors 6DF-1N2-C2-HWL and 6DF-1N6-C2-HWL. For communication the J1939 protocol is used.

Devices from the JD sensor series by ifm Electronic embed a six-axes (6 DOF) IMU with a 3D-gyroscope and a 3D-acceleration sensor. Measured data is provided via a CANopen interface. The unit with sensor fusion filters determines the basis inclination values. The data of the gyroscope

corrects the influences caused by acceleration, vibration or impact. The devices reach a static precision of  $\pm 0,3\text{ }^{\circ}$  and a dynamic precision of  $\pm 0,5\text{ }^{\circ}$  in moving systems. The integrated CANopen interface complies with the CiA 410 application profile for inclinometers. It is used for transfer of the measured values and for sensor parameter setting. An integrated terminating resistor may be activated via software. The IP67 or IP69K protected devices with aluminum housing may be mounted horizontally or vertically. The sensors with the operating temperature range from  $-40\text{ }^{\circ}\text{C}$  to  $+85\text{ }^{\circ}\text{C}$  are designed for detection of inclination angles and positions of mobile machines. Typical applications are horizontal levelling of platforms or boom measurement on wheeled excavators.

### Integration in robotic solutions

A robot has to fulfill such operations as to sense, to think, and to act. The Robokit platform by TDK offers such operation blocks. For sensing, the platform includes the 6-DOF IMU ICM-42688-P from Invensense, a pressure sensor, a magnetometer, a temperature sensor, as well as ultrasonic Chirp TOF (time-of-flight) sensors for 3-D sensing of the surroundings. For thinking, a Cortex M7 processor runs algorithms to drive the intelligence of the robot. For act operation, a CAN network interconnects mentioned devices with the motor controllers from Micronas. The motor controllers use an ASIL-A-ready firmware and configuration tool by Newtec. The platform software runs the ROS (robot operating system). ROS-ready drivers for IMU and ultrasonic range sensor are available. Invensense, Chirp, and Micronas are members of the TDK group.

TDK and Qualcomm Technologies announced the compatibility of the Robokit with the Qualcomm Robotics RB3 platform. Here, TDK provides the CAN-capable sensing and acting solutions. Qualcomm enables the thinking operation using company's SDA845 processor. Main applications of the platform are industrial robotics, consumer robotics, and drones.

### Designed for light vehicles

The Italian company E-Shock offers CAN-capable inertial measuring units with six degrees of freedom (6 DOF). Bit-rates of up to 1 Mbit/s and 11-bit CAN-Identifier are supported. The E-Lean Advanced IMU is designed to provide estimation of vehicle attitude in terms of roll, pitch, and side slip angles based on a data fusion algorithm. The E-Shark IMU is equipped with a 16-bit micro-controller with digital signal processing unit and a GPS. It provides



Figure 4: JD sensor series (Source: ifm Electronic)

## Overview of described IMUs

Company	IMU name	DOF number	HLP protocol
Anceinna	Openimu300ri	9 DOF	Proprietary or J1939
Basecam (sensor Invensense)	CAN IMU	6 DOF	Proprietary
Epson	M-G550PC2	6 DOF	CANopen
E-Shock	E-Lean Advanced E-Shark	6 DOF	Proprietary

position, heading, and speed of the vehicle. Target vehicles range from motorbikes and cars to light ICE (internal combustion engine) and electric autonomous vehicles.

E-Lean-Race-Pro IMU is specifically designed for racing applications. Due to its milled IP67-rated aluminum housing adoption in heavy-duty applications is possible as well. Connected to the vehicle's CAN network the IMU receives the vehicle speed information and provides the acceleration signals ( $A_x$ ,  $A_y$ ,  $A_z$ ), the angular rate signals ( $W_x$ ,  $W_y$ ,  $W_z$ ), the estimation of the vehicle's attitude, and the diagnosis status of the hardware. The unit is used in two-wheeled and four-wheeled vehicle applications. These include slide out and low-side identification (motorcycles), rollover identification (cars), traction and braking control, suspension and stability control, adaptive lighting, airbag triggering, as well as energy management, and range prediction in electric vehicles.

### IMUs for diverse applications



Figure 5: The Robokit platform (Source: TDK)

LPMS-Canal2 motion sensor by LP-Research is a nine-axis (9 DOF) IMU and AHRS with CAN connectivity. Orientation data measurement around three axes is achieved using three separate Mems-sensors (3-axis gyroscope, 3-axis accelerometer, and 3-axis magnetometer). The unit contains a 32-bit digital signal processor running the calculations on-board

in real-time. The CAN interface supports CANopen or a customized LP-CAN higher-layer protocol. The amount of measurement data transmitted via CAN is configurable using the LPMS-Control data acquisition software. Device configuration via CAN from a Windows PC requires a Peak CAN-to-USB interface, which is not included with the sensor. The company also offers the LPMS-CU2 9-axis IMU and AHRS with CAN and USB (version 2) connectivity. The unit performs orientation and relative displacement measurements. Additionally, temperature and barometric pressure sensors allow altitude measurements. CAN interface-related features are the same as for the LPMS-Canal2. Both IMUs are dedicated for robotic manipulator forward kinematics control, automotive dead reckoning,

object orientation tracking as well as automatic guided vehicle (AGV) navigation.

The CAN IMU from Basecam works with the company's SimpleBGC 32-bit Extended and BasecamBGC Pro controllers. Storage of calibration data is possible. The unit integrates the 6-DOF sensor ICM20608 from Invensense. I<sup>2</sup>C and UART interfaces may be used for the external device connectivity. The board size is 25 mm × 25 mm and it is optionally available in a box version. For proper functionality of the IMU, the firmware version 2.61b2 or above is required. Firmware upgrade may be done via a CAN-to-PC interface using the SimpleBGC32 graphical user interface.

IM-1 by Techmor (USA) is a 6-DOF IMU with CAN connectivity. It measures accelerations of up to 18 g and angular rates of up to  $\pm 150$  °/s on three axes respectively. Each axis measurement is provided as a 16-bit value. The three-grouped acceleration values and the three-grouped angular rates are transmitted in a corresponding CAN message each. With its compensated temperature range of -40 °C to +105 °C and the sealed Autosport connector by Deutsch the unit may be used for vehicle testing, motion tracking, navigation, stability control, and in autonomous vehicles.

Epson offers the M-G550PC2 IMU with six degrees of freedom (6-DOF) measuring tri-axial angular rates of  $\pm 150$  °/s and linear accelerations of  $\pm 5$  g. The device provides a CANopen interface according to CiA 301 (CANopen application layer and communication profile) and supports the CiA 404 CANopen device profile for measuring devices and closed-loop controllers. Bit-rates up to 1 Mbit/s are supported. The IP67-protected IMU is packaged in a dust-proof metallic case suitable for use in such applications as motion and vibration measurement, platform stabilization, attitude detection for unmanned systems, as well as vibration control and stabilization. ◀

#### Author

Olga Fischer  
CAN Newsletter  
[pr@can-cia.org](mailto:pr@can-cia.org)  
[www.can-newsletter.org](http://www.can-newsletter.org)





*CAN in Automation*

The non-profit CiA organization promotes CAN and CAN FD, develops CAN FD recommendations and CANopen specifications, and supports other CAN-based higher-layer protocols such as J1939-based approaches.

## *Join the community!*

- ▶ Initiate and influence CiA specifications
- ▶ Get credits on CiA training and education events
- ▶ Download CiA specifications, already in work draft status
- ▶ Get credits on CiA publications
- ▶ Receive the exclusive, monthly CiA Member News (CMN) email service
- ▶ Get CANopen vendor-IDs free-of-charge
- ▶ Participate in plugfests and workshops
- ▶ Get the classic CANopen conformance test tool
- ▶ Participate in joint marketing activities
- ▶ Develop partnerships with other CiA members
- ▶ Get credits on CiA testing services

*For more details please contact CiA office  
at [headquarters@can-cia.org](mailto:headquarters@can-cia.org)*

*[www.can-cia.org](http://www.can-cia.org)*